

20 24



Catalogue_01

20
24



Catalogue_01



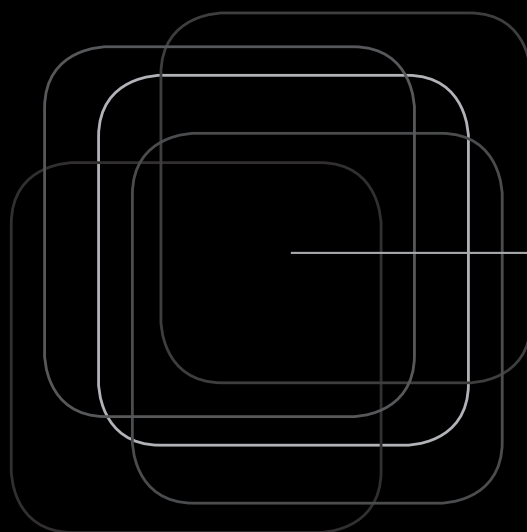



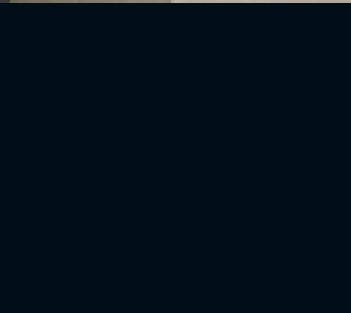
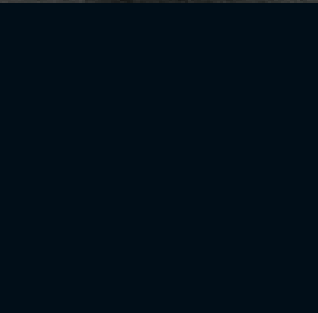
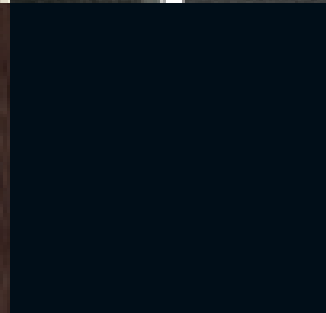
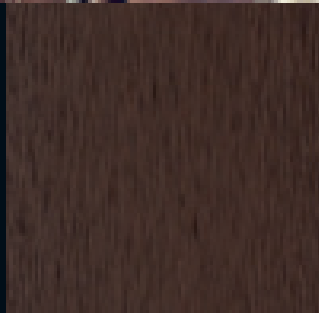
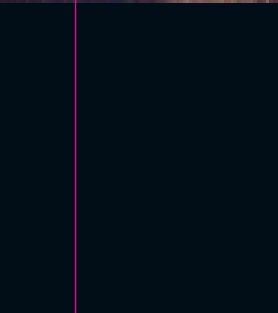
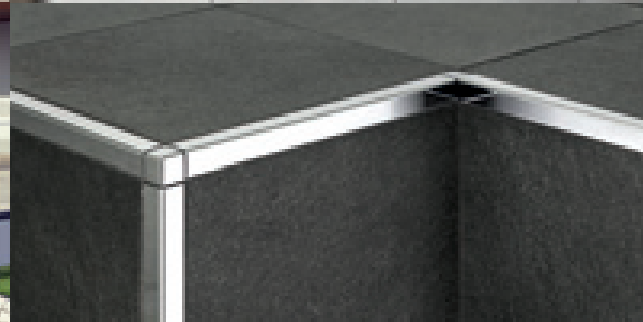
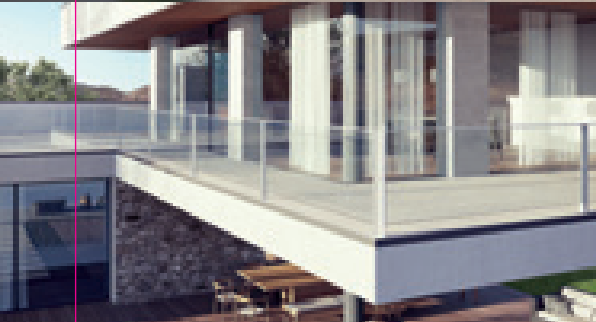
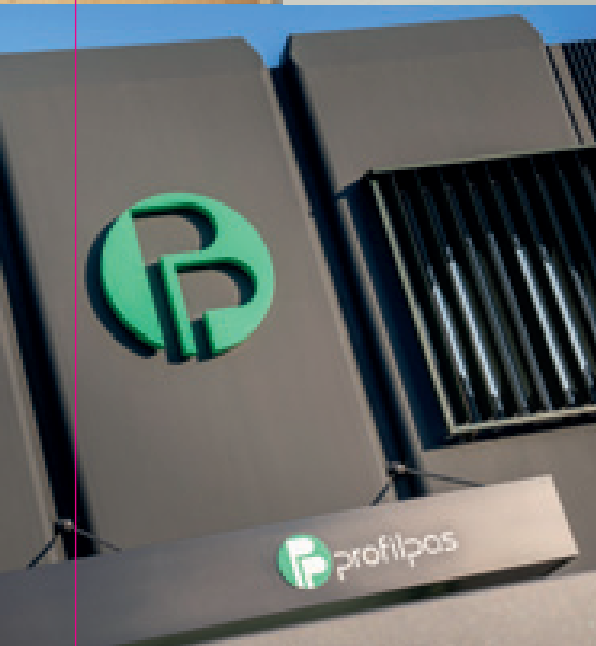
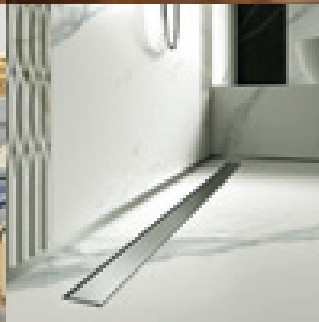
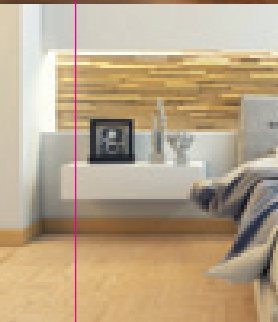
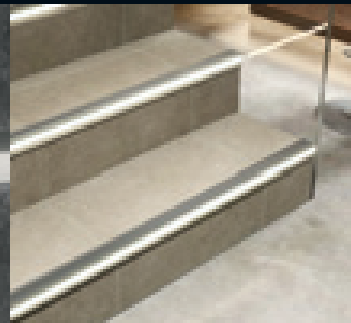





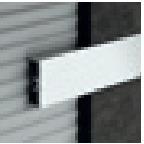







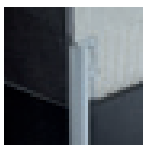

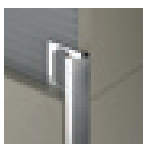





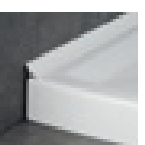
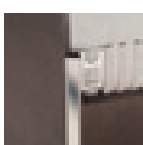

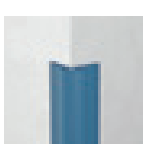

Design is our best profile.





Index

| | | | | | | | | | |
|---|---|---|---|---|---|---|---|---|----------------------------------|
| external corners profiles |  | CERFIX® PROANGLE Q page 18 | listellos and decorative profiles |  | CERFIX® PROLIST page 50 | linear drains and bathroom systems |  | PP DRAIN AQUA page 68 | |
| |  | CERFIX® PROANGLE page 26 | |  | METAL LINE AF - M DESIGN page 51 | |  | THIN DRAIN page 73 | |
| |  | CERFIX® PROTRIM IP page 31 | |  | CERFIX® PROLIST-X DESIGN page 51 | |  | SLIM DRAIN page 75 | |
| |  | CERFIX® PROTRIM page 32 | |  | CERFIX® PRODECOR - C DESIGN page 52-53 | |  | SMART DRAIN page 77 | |
| |  | CERFIX® PROTRIM N page 35 | |  | CERFIX® PROSTYLE - C DESIGN page 52-53 | |  | Q DRAIN page 79 | |
| |  | CERFIX® PROANGLE F page 40 | | | | |  | GLASS PROFILE page 82 | |
| |  | CERFIX® PROANGLE AX - M DESIGN page 41 | internal corners profiles |  | CERFIX® PROROUND M page 56 | |  | SANIBORD page 90 | |
| |  | CERFIX® PRONIVEL M page 41 | |  | CERFIX® PROROUND P page 59 | | | | |
| |  | PROCORNER M page 42 | |  | CERFIX® PROROUND M GIC/ page 60 | | profiles for floors of same height |  | CERFIX® PROANGLE page 94 |
| |  | PROCORNER P page 44 | |  | CERFIX® PROINT page 60-61 | | |  | CERFIX® PROANGLE B page 95 |
|  | CERFIX® PROBORD page 46 |  | | PROROUND B page 62 |  | CERFIX® PROANGLE FLEX page 96 | | | |
|  | CERFIX® PROTOP page 47 | | | |  | CERFIX® PRODECOR DJ page 97 | | | |



CERFIX®
PRODECOR DJ
FLEX
page 97

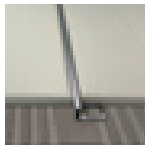

CERFIX®
PRODECOR
page 97



CERFIX®
PROSTYLE
page 98



PROJOINT U
page 99



PROJOINT
page 99

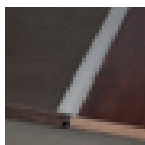

PROJOINT T
page 100



PROJOINT R
page 102



PROJOINT M
page 102



PROCLASSIC R
page 103



PROCLASSIC F
page 106



CERFIX®
PRONIVEL P
page 111



CERFIX®
PRONIVEL L
page 112



CERFIX®
PRONIVEL PB
page 112



CERFIX®
PRONIVEL PL
page 113



CERFIX®
PRONIVEL M
page 113



PROLEVEL
HIGH
page 114



PROLEVEL
MEDIUM
page 116



PROLEVEL
THIN
page 117

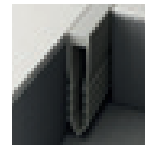

CERFIX®
PROJOINT
DIL NF
page 121



CERFIX®
PROJOINT DIL
NAN
page 122



CERFIX®
PROJOINT DIL
NPAN
page 122



CERFIX®
PROJOINT DIL
NIN
page 123



CERFIX®
PROJOINT DIL
NIL
page 123



CERFIX®
PROJOINT DIL
NTA - NTI - NTO
page 124



CERFIX®
PROJOINT DIL
STA - STI
page 124



CERFIX®
PROJOINT DIL
NZA
page 125



CERFIX®
PROJOINT DIL
NZS
page 125



CERFIX®
PROJOINT DIL
PBE
page 126



CERFIX®
PROJOINT DIL
PBH
page 127



CERFIX®
PROJOINT DIL
PAS
page 127

movement joints



CERFIX®
PROJOINT
DIL NE
page 120



CERFIX®
PROJOINT
DIL NJ
page 120



CERFIX®
PROJOINT
DIL NL
page 121

profiles for floors of different height



CERFIX®
PRONIVEL N
page 110

Index



CERFIX®
PROJOINT DIL
PHDE
page 128



CERFIX®
PROJOINT DIL
PFFE
page 128



CERFIX®
PROCOVER
FLEX
page 129

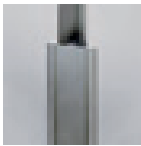

CERFIX®
PROCOVER FIX
page 129



CERFIX®
PROCOVER
page 130



CERFIX®
PROTEC CPEV
- CPEI
page 140



CERFIX®
PROTEC CPNV
page 142

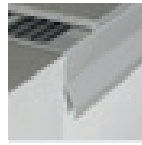

CERFIX®
PROTEC CPBV
page 143



CERFIX®
PROTEC CPHA
- CPHV
page 144



CERFIX®
PROTEC CPLB
- CPLV
page 145

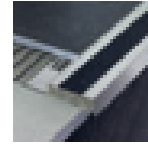

CERFIX®
PROSTEP SIX
page 151

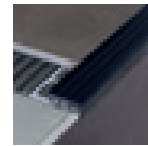

CERFIX®
PROSTEP SP
page 152



CERFIX®
PROSTEP SA
- SB
page 152



PROTECT
page 154



SAFETY-STEP
page 162



PROSTAIR
page 164

profiles for balconies and terraces



CERFIX®
PROTEC CPCV
- CPCI
page 134

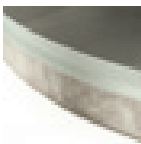

CERFIX®
PROTEC CPCVF
page 134



CERFIX®
PROTEC
CPCV/30/
page 136



CERFIX®
PROTEC
CPCVD/30/
page 137



CERFIX®
PROTEC CPGV
page 138

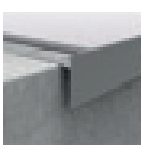

CERFIX®
PROTEC CPQV
page 139

stair nosing profiles



CERFIX®
PROSTEP SGA -
SGI - SGN - SGK
page 148



CERFIX®
PROSTEP SMA
- SM
page 148



CERFIX®
PROTRIM IP
page 149



CERFIX®
PROSTEP SNG
- SN
page 149



CERFIX®
PROSTEP SAR
- SIR
page 150



CERFIX®
PROSTEP SIS
page 151

profiles for wooden, laminate and LVT floors



UNISYSTEM
PLUS
page 170



PROFIX THIN
page 176



PRESTOWOOD
page 178



TERMINAL RC
page 181



TERMINAL RC
FLEX
page 181



ALFIX 616
page 182



ALFIX 46
page 183



CERFIX®
PROJINT DIL
page 184



CERFIX®
PRONIVEL PB
page 184-185



CERFIX®
PROJINT T
page 185



CERFIX®
PROSTEP
page 186



PROTECT
page 186



CERFIX®
PROTRIM
page 187



CERFIX®
PROANGLE
page 187



CERFIX®
PROANGLE Q
page 187

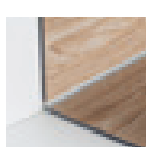

CERFIX®
PROROUND M
page 188

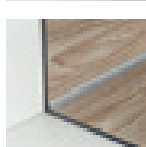

CERFIX®
PROINT
page 188

metal line



METAL LINE 90
page 194



METAL LINE 90
TREND COLOR
page 194

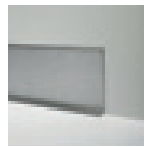

METAL LINE
790
page 196



METAL LINE 92
page 197



METAL LINE 93
page 197

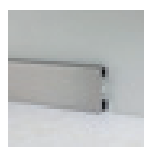

METAL LINE 89
page 198



METAL LINE 89
TREND COLOR
page 198

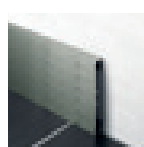

METAL LINE 89
I DESIGN
page 199

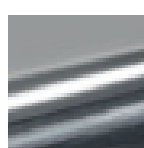

PROLIGHT
METAL LINE 89
page 199



METAL LINE
89/613
page 200



METAL LINE
105
page 201

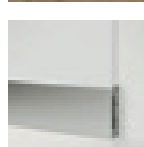

METAL LINE
87 - 88
page 202

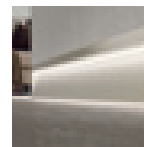

PROLIGHT
METAL LINE S
SKL/2
page 203



METAL LINE AF
- M DESIGN
page 203



METAL LINE
100
page 204



METAL LINE
101
page 204

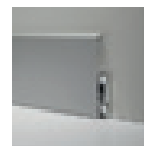

METAL LINE
95 - 94
page 205



METAL LINE 98
page 206

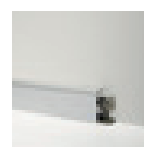

METAL LINE
97/4
page 207

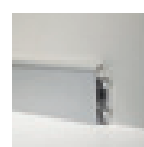

METAL LINE
97/7
page 208

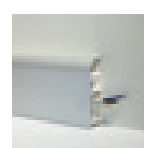

METAL LINE
97/8
page 209

pvc line

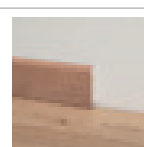

PVC LINE 8605
page 212



PVC LINE 8606
page 212

Index

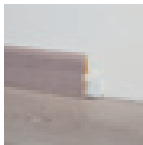

PVC LINE 8608
page 213



PVC LINE 8615
page 214



PVC LINE 8616
page 214



PVC LINE 8613
page 215



PVC LINE 8612
page 216



PVC LINE 8614
page 216



PVC LINE 8600
page 217

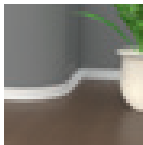

PVC LINE 8181
page 217

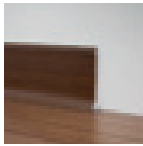

PVC LINE 8596
- 8598
page 218



PVC LINE 8580
- 8582
page 218



PVC LINE 8602
page 219



PVC LINE 8603
page 220

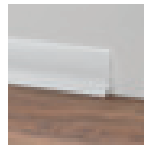

PVC LINE 8607
page 221



PVC LINE 148 -
172 - 173
page 222



PVC LINE 170 -
169 - 171
page 223

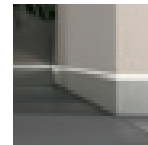

PROLIGHT
METAL LINE
87/88
page 233

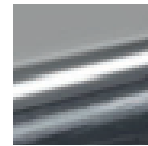

PROLIGHT
METAL LINE 89
page 234



ELECTRICAL
COMPONENTS
page 236

prolight

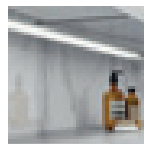

PROLIGHT
PROLIST LLA
- LLB
page 226



PROLIGHT
PROLIST TLA
- CLA
page 227

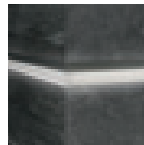

PROLIGHT
PROLIST Q LQL
page 228

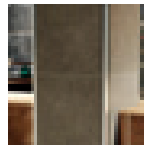

PROLIGHT
PROANGLE Q
ZQAL
page 229



PROLIGHT
PROSTEP
SGA/11L
page 230

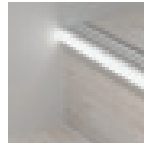

PROLIGHT
PROTECT G/9/F
page 230



PROLIGHT
PROTECT
126/L/F
page 231

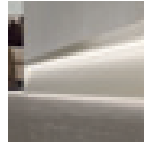

PROLIGHT
METAL LINE S
SKL/2
page 232

technical
entrance
mats

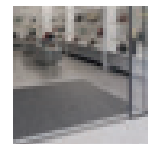

PROMAT
page 241

accessories
for
installation



PROTILER
page 245



FIX LEVEL
page 246

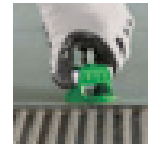

KLIC LEVEL
page 247



SPACERS
WEDGES
page 248



ACCESSORIES
FOR
INSTALLATION
page 249



PROFLEX
MACHINE
page 250

DIY profiles



DIY PROFILES
page 252

merchandising
for the point
of sale



MERCHANDISING
FOR THE POINT
OF SALE
page 260

index by
item

page 272

stainless steel

| | |
|--|---|
| | SS polished stainless steel AISI 304 DIN 1.4301 |
| | SS3 polished stainless steel AISI 316 DIN 1.4404 |
| | SS0 polished stainless steel AISI 430 DIN 1.4016 |
| | SSP superpolished stainless steel AISI 304 DIN 1.4301 |
| | SSS brushed stainless steel AISI 304 DIN 1.4301 |
| | SSB sandblasted stainless steel AISI 304 DIN 1.4301 |
| | SSS3 brushed stainless steel AISI 316 DIN 1.4404 |
| | CSS3 chromium-plated stainless steel AISI 316 DIN 1.4404 |
| | SSS0 brushed stainless steel AISI 430 - DIN 1.4016 |
| | BM matt black RAL 9005 colour-coated stainless steel AISI 304 DIN 1.4301 |

brass

| | |
|--|--------------------------------|
| | BN natural |
| | BP polished |
| | BCP plated polished |
| | BCG 24kt gold plated |

aluminium

| | |
|--|----------------------|
| | AN natural |
|--|----------------------|

anodised aluminium

| | |
|--|---------------------------|
| | AS silver |
| | AG gold |
| | ASG sand gold |
| | AT titanium |
| | AB bronze |
| | ABE bronze elox |
| | ABL black |

anodised aluminium X Design - I Design

| | |
|--|------------------------|
| | APX platinum |
| | ATX titanium |
| | ABX brown |

| | |
|--|---------------------------|
| | ABBX dark brown |
|--|---------------------------|

| | |
|--|----------------------|
| | ACX carbon |
|--|----------------------|

bright polished aluminium

| | |
|--|-----------------------|
| | ABPS silver |
|--|-----------------------|

| | |
|--|---------------------|
| | ABPG gold |
|--|---------------------|

| | |
|--|-------------------------|
| | ABPT titanium |
|--|-------------------------|

| | |
|--|-----------------------|
| | ABPC copper |
|--|-----------------------|

bright brushed aluminium

| | |
|--|-----------------------|
| | ABSS silver |
|--|-----------------------|

| | |
|--|---------------------|
| | ABSG gold |
|--|---------------------|

| | |
|--|-------------------------|
| | ABST titanium |
|--|-------------------------|

| | |
|--|-----------------------|
| | ABSC copper |
|--|-----------------------|

| | |
|--|----------------------|
| | ABSB black |
|--|----------------------|

bright scratched aluminium

| | |
|--|-----------------------|
| | ABBS silver |
|--|-----------------------|

colour-coated aluminium

| | |
|--|----------------------------------|
| | AC RAL 9003 matt white |
|--|----------------------------------|

| | |
|--|-----------------------------|
| | AC RAL 9003 white |
|--|-----------------------------|

| | |
|--|----------------------------------|
| | AC RAL 9010 matt white |
|--|----------------------------------|

| | |
|--|--------------------------------------|
| | AC RAL 9010 polished white |
|--|--------------------------------------|

| | |
|--|----------------------------------|
| | AC RAL 8019 dark brown |
|--|----------------------------------|

| | |
|--|--------------------------------|
| | AC RAL 7038 ash grey |
|--|--------------------------------|

| | |
|--|---|
| | AC RAL 7038 ash grey embossed |
|--|---|

| | |
|--|----------------------------------|
| | AC RAL 9006 metal grey |
|--|----------------------------------|

| | |
|--|--------------------------------------|
| | AC RAL 9007 aluminium grey |
|--|--------------------------------------|

colour-coated aluminium Trend Color

| | |
|--|---------------------------|
| | AC anthracite grey |
|--|---------------------------|

| | |
|--|----------------|
| | AC rust |
|--|----------------|

| | |
|--|------------------------|
| | AC ancient grey |
|--|------------------------|

| | |
|--|-----------------|
| | AC beige |
|--|-----------------|

| | |
|--|----------------|
| | AC sand |
|--|----------------|

| | |
|--|------------------|
| | AC greige |
|--|------------------|

| | |
|--|-----------------|
| | AC stone |
|--|-----------------|

| | |
|--|----------------|
| | AC grey |
|--|----------------|

| | |
|--|------------------|
| | AC bronze |
|--|------------------|

| | |
|--|----------------------|
| | AC dark brown |
|--|----------------------|

| | |
|--|-----------------------|
| | AC white stone |
|--|-----------------------|

| | |
|--|-----------------------|
| | AC black stone |
|--|-----------------------|

| | |
|--|--------------------------|
| | AC concrete white |
|--|--------------------------|

| | |
|--|-----------------------------|
| | AC concrete graphite |
|--|-----------------------------|

| | |
|--|--------------------------|
| | AC concrete smoke |
|--|--------------------------|

| | |
|--|------------------------|
| | AC concrete mud |
|--|------------------------|

| | |
|--|-------------------------|
| | AC concrete sand |
|--|-------------------------|

| | |
|--|----------------------|
| | AC metal dark |
|--|----------------------|

| | |
|--|-----------------------|
| | AC metal light |
|--|-----------------------|

| | |
|--|-----------------------|
| | AC solid white |
|--|-----------------------|

decors Alcom® Plus

| | |
|--|----|
| | 02 |
|--|----|

| | |
|--|----|
| | 05 |
|--|----|

| | |
|--|----|
| | 08 |
|--|----|

| | |
|--|----|
| | 10 |
|--|----|

| | |
|--|----|
| | 11 |
|--|----|

| | |
|--|----|
| | 12 |
|--|----|

| | |
|--|----|
| | 13 |
|--|----|

| | |
|--|----|
| | 14 |
|--|----|

| | |
|--|----|
| | 18 |
|--|----|

| | |
|--|----|
| | 19 |
|--|----|

| | |
|--|----|
| | 20 |
|--|----|

| | |
|--|----|
| | 25 |
|--|----|

| | |
|--|----|
| | 26 |
|--|----|

| | |
|--|----|
| | 31 |
|--|----|

| | |
|--|----|
| | 32 |
|--|----|

| | |
|--|----|
| | 34 |
|--|----|

| | |
|--|----|
| | 35 |
|--|----|

| | |
|--|----|
| | 36 |
|--|----|

| | |
|--|----|
| | 37 |
|--|----|

| | |
|--|----|
| | 38 |
|--|----|

| | |
|--|----|
| | 39 |
|--|----|

| | |
|--|----|
| | 40 |
|--|----|

| | |
|--|----|
| | 41 |
|--|----|

| | |
|--|----|
| | 42 |
|--|----|

| | |
|--|----|
| | 43 |
|--|----|

| | |
|--|----|
| | 44 |
|--|----|

| | |
|--|----|
| | 47 |
|--|----|

| | |
|--|----|
| | 65 |
|--|----|

| | |
|--|----|
| | 71 |
|--|----|

| | |
|--|----|
| | 72 |
|--|----|

| | |
|--|----|
| | 73 |
|--|----|

| | |
|--|----|
| | 74 |
|--|----|

| | |
|--|----|
| | 76 |
|--|----|

| | |
|--|----|
| | 77 |
|--|----|

| | |
|--|----|
| | 78 |
|--|----|

| | |
|--|----|
| | 79 |
|--|----|

| | |
|--|----|
| | 80 |
|--|----|

| | |
|--|----|
| | 81 |
|--|----|

| | |
|--|----|
| | 89 |
|--|----|

| | |
|--|----|
| | 91 |
|--|----|

| | |
|--|----|
| | 92 |
|--|----|

| | |
|--|----|
| | 93 |
|--|----|

| | |
|--|----|
| | 94 |
|--|----|

| | |
|--|------|
| | 95 |
| | 351 |
| | 363 |
| | 372 |
| | 490 |
| | 560 |
| | 580 |
| | 590 |
| | 665 |
| | 670 |
| | 951 |
| | 975 |
| | 1003 |
| | 1006 |
| | 1009 |
| | 1012 |
| | 1021 |
| | 1024 |
| | 1030 |
| | 1033 |
| | 1036 |
| | 1042 |
| | 1045 |
| | 1051 |
| | 1054 |
| | 1057 |
| | 1060 |
| | 1063 |
| | 1066 |
| | 1069 |

| | |
|--|---------------------------------|
| | 1081 |
| | 1084 |
| | 1090 |
| | 1093 |
| | 1096 |
| | 1099 |
| | 1102 |
| | 1105 |
| | 1108 |
| | 1111 |
| | 1202 |
| | 1203 |
| | 1204 |
| | 1205 |
| | 1206 |
| | 1207 |
| | 1208 |
| | 1209 |
| | 1210 |
| | 1211 |
| | 1212 |
| | 1213 |
| | 1214 |
| | 1215 |
| | 1216 |
| | 1217 |
| | 96 - embossed white RAL 9010 |
| | 97 - embossed black RAL 9005 |
| | 99 - brushed silver |
| | 100 - brushed steel |

PVC

| | |
|--|-----------------------------------|
| | code 400 snow white |
| | code 402 white |
| | code 404 9001 cream white |
| | code 406 RAL 1015 - ivory |
| | code 408 RAL 1019 - beige grey |
| | code 410 RAL 7030 - stone grey |
| | code 412 RAL 7038 - ash grey |
| | code 414 RAL 7035 - light grey |
| | code 416 anthracite |
| | code 418 blue |
| | code 420 pastel blue |
| | code 422 light green |
| | code 424 RAL 3002 - red |
| | code 426 RAL 9005 - black |
| | code 428 RAL 1023 - yellow |
| | code 430 pastel pink |
| | code 432 beige bahama |
| | code 434 peach |
| | code 436 caramel |
| | code 438 brown |
| | code 440 dark brown |
| | code 442 coral red |
| | code 444 raw sienna |
| | code 446 terracotta |

foam PVC

| | |
|--|-----------|
| | decor 518 |
| | decor 520 |
| | decor 524 |
| | decor 525 |

| | |
|--|----------------------|
| | decor 528 |
| | decor 530 |
| | decor 531 |
| | decor 532 |
| | decor 533 |
| | decor 534 |
| | decor 536 |
| | decor 540 |
| | decor 542 |
| | decor 544 |
| | decor 545 |
| | decor 555 white |
| | decor 556 light grey |
| | decor 557 black |
| | decor 558 anthracite |
| | decor 559 grey |
| | decor 561 yellow |
| | decor 562 green |
| | decor 563 light blue |
| | decor 564 red |



external corners profiles

A line dedicated to the protection and finishing of outside corners of the wall tiles. Profiles are suitable for any type of environment for the variety of finishes available, matching perfectly with all types of ceramics and giving character to the compositions and linearity.



Proangle Q in aluminium is a line of universal profiles with square shape, specially designed to edge and protect the external corners of ceramic coverings, that can be also used for finishing worktops and platforms. ZQVNH/ boasts the certified antibacterial technology (in compliance with ISO 22196:2011 standards) which reduces the presence of the most dangerous bacteria up to 99%, thus assuring the best hygiene over time.



ZQBN/10 bright polished silver aluminium



PROANGLE Q

length = 270 cm - pack 20 pcs

| ART. | finishing | 4,5 | 6 | 8 | 9 | 10 | 11 | 12,5 | |
|--|-----------------------------------|-----|-------|-------|-------|-------|-------|-------|-------|
| ALUMINIUM | | | | | | | | | |
| | silver anodised | | 88772 | 88875 | 88876 | 88877 | 88878 | 88879 | 88880 |
| ZQAN/ | <i>euro/m</i> | | | | | | | | |
| | titanium anodised | | 88902 | 88903 | 88904 | 88905 | 88906 | 88907 | 88908 |
| ZQAN/ | <i>euro/m</i> | | | | | | | | |
| | black anodised | | - | - | 89205 | - | 89206 | 89207 | 89208 |
| ZQAN/ | <i>euro/m</i> | | | | | | | | |
| ZQBN/ | bright polished silver | | 88816 | 88919 | 88920 | 88921 | 88922 | 88923 | 88924 |
| ZQBN/ | <i>euro/m</i> | | | | | | | | |
| | bright polished gold | | 88933 | - | 88935 | - | 88937 | - | 88939 |
| ZQBN/ | <i>euro/m</i> | | | | | | | | |
| | bright polished titanium | | 88956 | 88964 | 88966 | 88968 | 88970 | 88972 | 88974 |
| ZQBRN/ | <i>euro/m</i> | | | | | | | | |
| | bright polished copper | | - | - | - | - | 88969 | - | 88971 |
| ZQBRN/ | <i>euro/m</i> | | | | | | | | |
| | bright brushed silver | | 88981 | 88982 | 88983 | - | 88985 | 88986 | 88987 |
| ZQBSN/ | <i>euro/m</i> | | | | | | | | |
| | bright brushed gold | | 88997 | - | 88999 | - | 89001 | - | 89003 |
| ZQTMN/ | <i>euro/m</i> | | | | | | | | |
| | bright brushed titanium | | 89013 | 89014 | 89015 | - | 89017 | - | 89019 |
| ZQBSN/ | <i>euro/m</i> | | | | | | | | |
| | bright brushed copper | | - | - | 89031 | - | 89033 | - | 89035 |
| ZQBSN/ | <i>euro/m</i> | | | | | | | | |
| | bright brushed black | | - | - | - | - | 89209 | 89210 | 89211 |
| ZQBSN/ | <i>euro/m</i> | | | | | | | | |
| | bright scratched silver | | 89061 | - | 89063 | - | 89065 | - | 89067 |
| ZQAGN/ | <i>euro/m</i> | | | | | | | | |
| COLOUR-COATED ALUMINIUM | | | | | | | | | |
| | colour-coated matt white RAL 9003 | | - | - | 89200 | - | 89202 | 89203 | 89204 |
| ZQVN/ | <i>euro/m</i> | | | | | | | | |
| | colour-coated white RAL 9003 | | 89077 | 89076 | 89079 | - | 89081 | 89078 | 89083 |
| ZQVN/ | <i>euro/m</i> | | | | | | | | |
| ANTIBACTERIAL COLOUR-COATED ALUMINIUM | | | | | | | | | |
| ZQVNH/ | colour-coated white RAL 9003 | | - | - | 89080 | - | 89082 | - | 89084 |
| ZQVNH/ | <i>euro/m</i> | | | | | | | | |

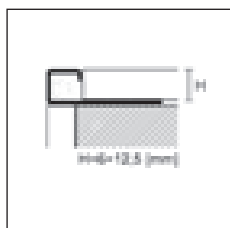
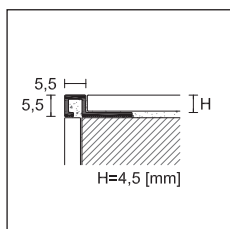

ZQAN/10 black anodised aluminium

Complete the article code with H measure (for example ZQAN/ for H=8 becomes ZQAN/8)

Items ZQVN available in different colours on demand minimum quantity 540 meters for colour



ZQAN/ /EI
silver anodised
aluminium

PROANGLE Q - OUTSIDE / INSIDE CORNERS / END CAPS

| pack 5 pcs | | H | | | | | | | |
|------------------|-----------------------------------|---|-------|-------|-------|-------|-------|-------|-------|
| ART. | finishing | | 4,5 | 6 | 8 | 9 | 10 | 11 | 12,5 |
| ALUMINIUM | | | | | | | | | |
| ZQAN/ /EI | silver anodised | | 88809 | 88882 | 88883 | 88884 | 88885 | 88886 | 88887 |
| | titanium anodised | | 88910 | 88911 | 88912 | 88913 | 88914 | 88915 | 88916 |
| <i>euro/pc</i> | | | | | | | | | |
| ZQAN/ /EI | black anodised | | - | - | 89223 | - | 89224 | 89225 | 89226 |
| | | | - | - | | - | | | |
| <i>euro/pc</i> | | | | | | | | | |
| ZQBN/ /EI | bright polished silver | | 88829 | 88926 | 88927 | 88928 | 88929 | 88930 | 88931 |
| | bright polished gold | | 88941 | - | 88943 | - | 88945 | - | 88947 |
| ZQVN/ /EI | colour-coated matt white RAL 9003 | | - | - | 89192 | - | 89194 | 89195 | 89196 |
| | colour-coated white RAL 9003 | | 89085 | 89086 | 89087 | - | 89089 | 89088 | 89091 |
| <i>euro/pc</i> | | | | | | | | | |
| ZQBN/ /EI | bright polished titanium | | 88976 | 88978 | 88980 | 88984 | 88988 | 88992 | 88996 |
| ZQBRN/ /EI | bright polished copper | | - | - | - | - | 88977 | - | 88979 |
| ZQBSN/ /EI | bright brushed silver | | 88989 | 88990 | 88991 | - | 88993 | 88994 | 88995 |
| | bright brushed gold | | 89005 | - | 89007 | - | 89009 | - | 89011 |
| ZQTMN/ /EI | bright brushed titanium | | 89021 | 89022 | 89023 | - | 89025 | - | 89027 |
| ZQBRSN/ /EI | bright brushed copper | | - | - | 89039 | - | 89041 | - | 89043 |
| ZQBSN/ /EI | bright brushed black | | - | - | - | - | 89227 | 89228 | 89229 |
| <i>euro/pc</i> | | | | | | | | | |
| ZQAGN/ /EI | bright scratched silver | | 89069 | - | 89071 | - | 89073 | - | 89075 |
| | | | | - | | - | | - | |
| <i>euro/pc</i> | | | | | | | | | |

no partial packaging

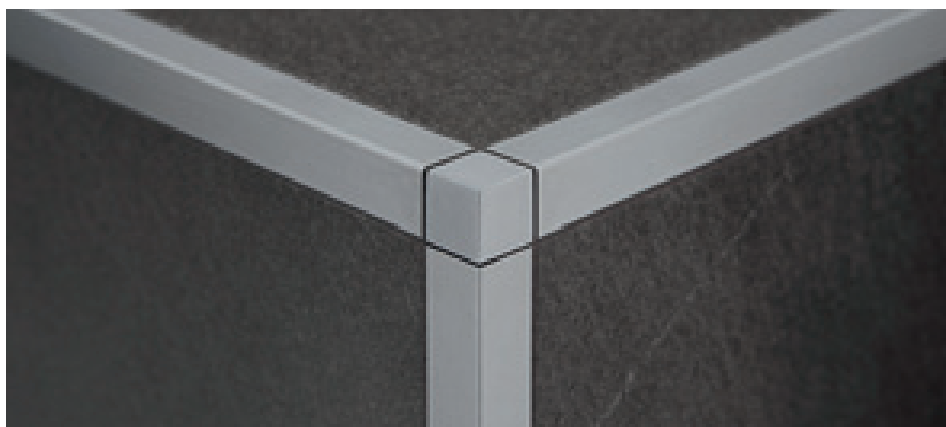

ZQAN/10 + ZQAN/10/EI silver anodised aluminium

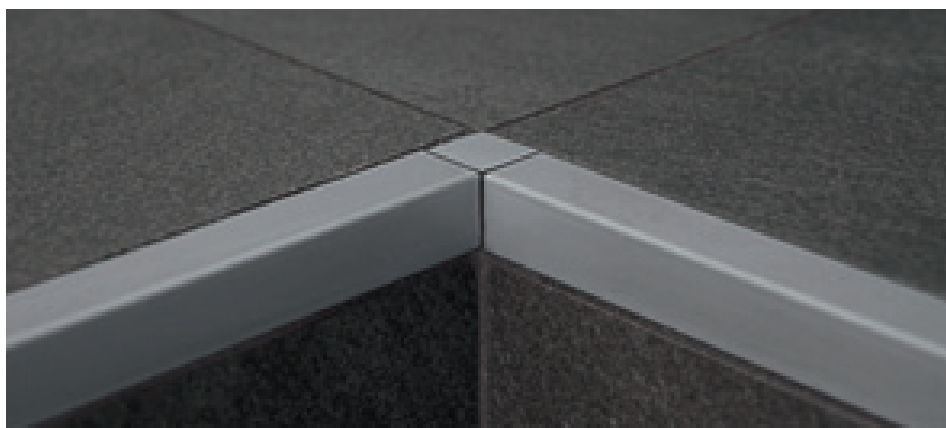

ZQAN/10 + ZQAN/10/EI silver anodised aluminium

Complete the article code with H measure
(for example ZQAN/ /EI for H=8 becomes
ZQAN/8/EI)

cerfix® proangle Q

Colour-coated aluminium Trend Color Stone: modern finishes with neutral but warm and soft shades which reproduce the heterogeneity of stone thanks to a rough texture.

Colour-coated aluminium Trend Color Concrete: six original cement-effect finishes that recall the typical metropolis colours by revisiting them from a more refined point of view.

Colour-coated aluminium Trend Color Metal: two special metal tonalities which reproduce the iridescent nature of metals.



ZQVN/10 stone colour-coated aluminium

PROANGLE Q - TREND COLOR

length = 270 cm - pack 20 pcs

| ART. | finishing | H | | | |
|------|-----------|---|----|----|------|
| | | 8 | 10 | 11 | 12,5 |

COLOUR-COATED ALUMINIUM

TREND COLOR STONE

| | | | | | |
|-----------------|--|-------|-------|-------|-------|
| dark brown | | 89360 | 89310 | 89311 | 89312 |
| anthracite grey | | 89093 | 89095 | 89106 | 89097 |
| ancient grey | | 89362 | 89220 | 89221 | 89222 |
| grey | | 89363 | 89290 | 89291 | 89292 |
| rust | | 89094 | 89096 | 89107 | 89098 |
| bronze | | 89365 | 89300 | 89301 | 89302 |
| stone | | 89366 | 89280 | 89281 | 89282 |
| greige | | 89367 | 89270 | 89271 | 89272 |
| sand | | 89368 | 89260 | 89261 | 89262 |
| beige | | 89369 | 89250 | 89251 | 89252 |
| white stone | | 89370 | 89320 | 89321 | 89322 |
| black stone | | 89371 | 89330 | 89331 | 89332 |

TREND COLOR CONCRETE

| | | | | | |
|-------------------|--|---|-------|-------|-------|
| concrete white | | - | 89131 | 89161 | 89181 |
| concrete graphite | | - | 89132 | 89162 | 89182 |
| concrete smoke | | - | 89133 | 89163 | 89183 |
| concrete mud | | - | 89134 | 89164 | 89184 |
| concrete sand | | - | 89135 | 89165 | 89185 |
| solid white | | - | 89138 | 89168 | 89188 |

TREND COLOR METAL

| | | | | | |
|-------------|--|---|-------|-------|-------|
| metal dark | | - | 89136 | 89166 | 89186 |
| metal light | | - | 89137 | 89167 | 89187 |

euro/m

individually packed - Other heights with TREND COLOR finishes are available upon request, with a minimum of 540 meters.

TREND
COLOR

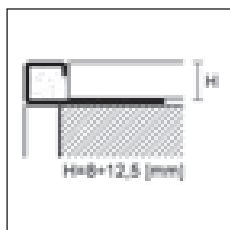

ZQVN/



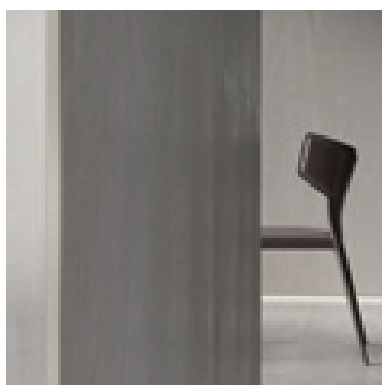

















ZQVN/



ZQVN/10 concrete white colour-coated aluminium

Complete the article code with H measure (for example ZQVN/ for H=10 becomes ZQVN/10).

PROANGLE Q - TREND COLOR - OUTSIDE / INSIDE CORNERS / END CAPS

| pack 5 pcs | | H | | | | |
|--------------------------------|-------------------|---|-------|-------|-------|-------|
| ART. | finishing | 8 | 10 | 11 | 12,5 | |
| COLOUR-COATED ALUMINIUM | | | | | | |
| TREND COLOR STONE | | | | | | |
| | dark brown |  | 89380 | 89303 | 89304 | 89305 |
| | anthracite grey |  | 89100 | 89102 | 89108 | 89104 |
| | ancient grey |  | 89382 | 89213 | 89214 | 89215 |
| | grey |  | 89383 | 89283 | 89284 | 89285 |
| | rust |  | 89101 | 89103 | 89109 | 89105 |
| | bronze |  | 89385 | 89293 | 89294 | 89295 |
| | stone |  | 89386 | 89273 | 89274 | 89275 |
| | greige |  | 89387 | 89263 | 89264 | 89265 |
| | sand |  | 89388 | 89253 | 89254 | 89255 |
| | beige |  | 89389 | 89243 | 89244 | 89245 |
| ZQVN/ /EI | white stone |  | 89390 | 89340 | 89341 | 89342 |
| | black stone |  | 89391 | 89350 | 89351 | 89352 |
| TREND COLOR CONCRETE | | | | | | |
| | concrete white |  | - | 89392 | 89402 | 89410 |
| | concrete graphite |  | - | 89394 | 89403 | 89411 |
| | concrete smoke |  | - | 89395 | 89404 | 89412 |
| | concrete mud |  | - | 89396 | 89405 | 89413 |
| | concrete sand |  | - | 89397 | 89406 | 89414 |
| | solid white |  | - | 89400 | 89409 | 89417 |
| TREND COLOR METAL | | | | | | |
| | metal dark |  | - | 89398 | 89407 | 89415 |
| | metal light |  | - | 89399 | 89408 | 89416 |
| euro/pc | | | | | | |

no partial packaging



ZQVN/ /EI
sand colour-coated
aluminium

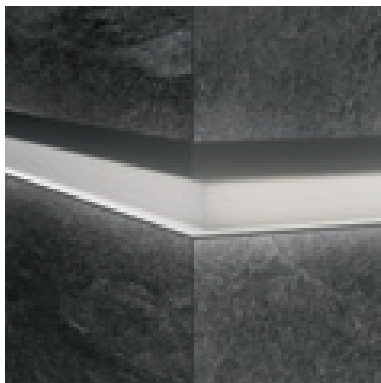

LED-light profiles and skirting boards with Trend Color finishes on page 228 and 232.

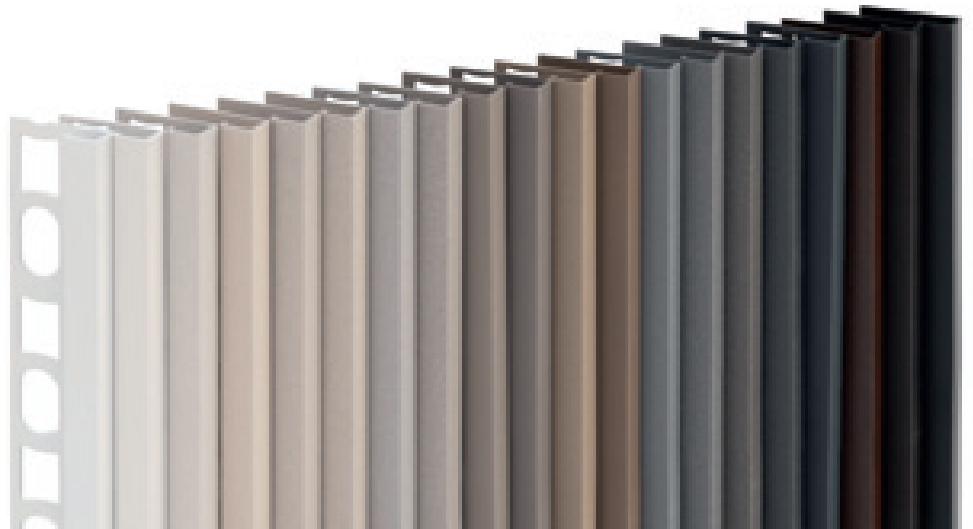

ZQVN/10 Trend Color finishes

Complete the article code with H measure (for example ZQVN/ /EI per H = 10 becomes ZQVN/10/EI).

cerfix® proangle Q

In anodised aluminium, X Design is characterized by a special scratched finish and original colours that allow different chromatic combinations, created for interior designers and architects by following the latest trends of modern design.



ZQAND/10 brown anodised aluminium



PROANGLE Q - X DESIGN

length = 270 cm - pack 20 pcs

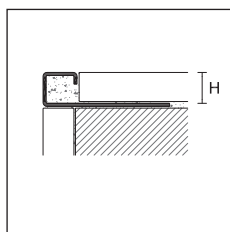

ZQAND/

| | | H | | | |
|---------------------------|------------|---|-------|-------|-------|
| ART. | finishing | 8 | 10 | 12,5 | |
| ANODISED ALUMINIUM | | | | | |
| ZQAND/ | platinum | | 31110 | 31112 | 31114 |
| | titanium | | 31120 | 31122 | 31124 |
| | brown | | 31130 | 31132 | 31134 |
| | dark brown | | 31140 | 31142 | 31144 |
| | carbon | | 31150 | 31152 | 31154 |

euro/m

individually packed

PROANGLE Q - X DESIGN - OUTSIDE / INSIDE CORNERS / END CAPS

pack 5 pcs



ZQAND/ EI
brown
anodised
aluminium

| | | H | | | |
|---------------------------|------------|---|-------|-------|-------|
| ART. | finishing | 8 | 10 | 12,5 | |
| ANODISED ALUMINIUM | | | | | |
| ZQAND/ EI | platinum | | 31160 | 31162 | 31164 |
| | titanium | | 31170 | 31172 | 31174 |
| | brown | | 31180 | 31182 | 31184 |
| | dark brown | | 31190 | 31192 | 31194 |
| | carbon | | 31200 | 31202 | 31204 |

euro/pc

no partial packaging



Complete the article code with H measure (for example ZQAND/ for H=8 becomes ZQAND/8)

Proangle Q in stainless steel is a line of universal profiles with square shape, specially designed to edge and protect the external corners of ceramic coverings.

They are also particularly suitable for the edging and the protection of floors and steps in different materials, such as ceramic, stone, wood and resins, and can be also used for finishing worktops and platforms.

Stainless steel makes the profile particularly resistant to chemical and atmospheric agents. The AISI 316 DIN 1.4404 quality offers superior resistance to corrosion and is therefore recommended for applications in areas subject to greater chemical stress, such as swimming pools and food industries, and coastal areas.



ZQINP/10 sandblasted stainless steel AISI 304-DIN 1.4301

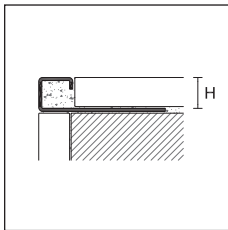

PROANGLE Q

length = 270 cm - pack 20 pcs

| ART. | finishing | | 6 | 8 | 9 | 10 | 11 | 12,5 | 15 |
|------------------------|---|--|-------|-------|-------|-------|-------|-------|-------|
| STAINLESS STEEL | | | | | | | | | |
| ZQIN/ | stainless steel AISI 304 - DIN 1.4301 | | 90049 | 90050 | 90051 | 90052 | 90053 | 90054 | 90055 |
| | <i>euro/m</i> | | | | | | | | |
| ZQINS/ | brushed stainless steel AISI 304 - DIN 1.4301 | | 90100 | 90101 | 90102 | 90103 | 90104 | 90105 | 90106 |
| ZQINP/ | sandblasted stainless steel AISI 304 - DIN 1.4301 | | 90130 | 90131 | 90132 | 90133 | 90134 | 90135 | 90136 |
| | <i>euro/m</i> | | | | | | | | |
| ZQINX/ | stainless steel AISI 316 - DIN 1.4404 | | - | 90107 | - | 90109 | - | 90111 | - |
| | <i>euro/m</i> | | - | - | - | - | - | - | - |

individually packed - ZQIN/15, ZQINS/15 and ZQINP/15 packaging of 10 pcs

PROANGLE Q - OUTSIDE / INSIDE CORNERS / END CAPS

pack 5 pcs

| ART. | finishing | | 6 | 8 | 9 | 10 | 11 | 12,5 | 15 |
|------------------------|---|--|-------|-------|-------|-------|-------|-------|-------|
| STAINLESS STEEL | | | | | | | | | |
| ZQIN/ /EI | stainless steel AISI 304 - DIN 1.4301 | | 90064 | 90065 | 90066 | 90067 | 90068 | 90069 | 90070 |
| | <i>euro/pc</i> | | | | | | | | |
| ZQINS/ /EI | brushed stainless steel AISI 304 - DIN 1.4301 | | 90112 | 90113 | 90114 | 90115 | 90116 | 90117 | 90118 |
| ZQINP/ /EI | sandblasted stainless steel AISI 304 - DIN 1.4301 | | 90137 | 90138 | 90139 | 90140 | 90141 | 90142 | 90143 |
| | <i>euro/pc</i> | | | | | | | | |
| ZQINX/ /EI | stainless steel AISI 316 - DIN 1.4404 | | - | 90119 | - | 90121 | - | 90123 | - |
| | <i>euro/pc</i> | | - | - | - | - | - | - | - |
| METAL | | | | | | | | | |
| ZQIM/ /EI | polished stainless steel | | - | 90092 | 90093 | 90094 | 90095 | 90096 | - |
| | <i>euro/pc</i> | | - | - | - | - | - | - | - |
| ZQIMS/ /EI | brushed steel | | - | 90152 | 90153 | 90154 | 90155 | 90156 | - |
| | <i>euro/pc</i> | | - | - | - | - | - | - | - |
| ZQIMP/ /EI | sandblasted steel | | - | 90162 | 90163 | 90164 | 90165 | 90166 | - |
| | <i>euro/pc</i> | | - | - | - | - | - | - | - |

no partial packaging for ZQIM/ /EI, ZQIMS/ /EI and ZQIMP/ /EI



ZQIN/ /EI stainless steel AISI 304 - DIN 1.4301



ZQIN/10/EI stainless steel AISI 304 - DIN 1.4301

Complete the article code with H measure (for example ZQIN/ for H=8 becomes ZQIN/8)

external corners profiles

cerfix® proangle Q

Proangle Q in polished brass is classic and modern at the same time and can be easily combined to handles, taps and other furniture accessories of the same material and finish.

The chromium-plated version stands out for its brilliance and is perfect as decorative element in spaces characterized by elegance and attention to details.



ZQKN/10 chromium-plated brass

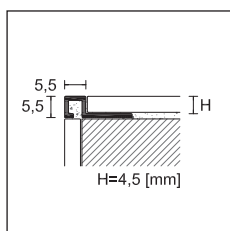

PPDESIGN

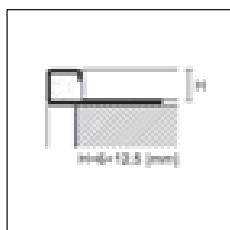

ZQKN/ EI
chromium-plated
brass

PROANGLE Q

length = 270 cm - pack 20 pcs

| ART. | finishing | 4,5 | 8 | H | 10 | 11 | 12,5 |
|------|-----------|-----|---|---|----|----|------|
|------|-----------|-----|---|---|----|----|------|

POLISHED BRASS

| | | | | | | | |
|-------|----------|--|-------|-------|-------|-------|-------|
| ZQLN/ | polished | | 90022 | 90056 | 90057 | 90063 | 90058 |
|-------|----------|--|-------|-------|-------|-------|-------|

euro/m

CHROMIUM-PLATED BRASS

| | | | | | | | |
|-------|-----------------|--|-------|-------|-------|-------|-------|
| ZQKN/ | chromium plated | | 88870 | 90059 | 90060 | 90074 | 90061 |
|-------|-----------------|--|-------|-------|-------|-------|-------|

euro/m

individually packed - ZQKN/12,5 packaging of 10 pcs

PROANGLE Q - OUTSIDE / INSIDE CORNERS / END CAPS

length = 270 cm - pack 5 pcs

| ART. | finishing | 4,5 | 8 | H | 10 | 11 | 12,5 |
|------|-----------|-----|---|---|----|----|------|
|------|-----------|-----|---|---|----|----|------|

BRASS

| | | | | | | | |
|----------|----------|--|-------|-------|-------|-------|-------|
| ZQLN/ EI | polished | | 90062 | 90071 | 90072 | 90075 | 90073 |
|----------|----------|--|-------|-------|-------|-------|-------|

euro/pc

| | | | | | | | |
|----------|-----------------|--|-------|-------|-------|-------|-------|
| ZQKN/ EI | chromium plated | | 88872 | 90077 | 90083 | 90085 | 90087 |
|----------|-----------------|--|-------|-------|-------|-------|-------|

euro/pc

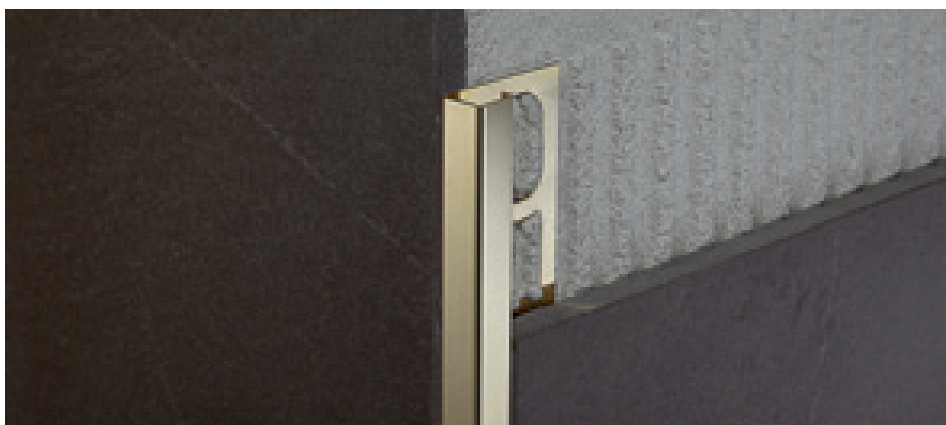

ZQLN/10 polished brass

Complete the article code with H measure
(for example ZQLN/ for H=8 becomes ZQLN/8)

Proangle Q in coextruded PVC is a line of universal profiles with square shape, specially designed to edge and protect the external corners of ceramic coverings. Thanks to the special section with soft PVC inserts, these profiles absorb the micro-movements that discharge on the corner due to the tension of the wall coverings.



ZQP/8 white PVC

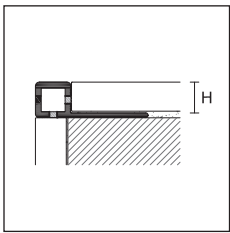









ZQP/



ZQP/8 beige bahama PVC

PROANGLE Q

length = 270 cm

| | | H | | | | |
|------------------------|----------------------|---|-------|-------|-------|-------|
| ART. | finishing | 6 | 8 | 10 | 12,5 | |
| CO-EXTRUDED PVC | | | | | | |
| | white |  | 80800 | 80801 | 80802 | 80803 |
| | cream white RAL 9001 |  | 80804 | 80805 | 80806 | 80807 |
| | ivory RAL 1015 |  | 80808 | 80809 | 80810 | 80811 |
| | beige grey RAL 1019 |  | 80812 | 80813 | 80814 | 80815 |
| ZQP/ | stone grey RAL 7030 |  | 80816 | 80817 | 80818 | 80819 |
| | light grey RAL 7035 |  | 80820 | 80821 | 80822 | 80823 |
| | anthracite |  | 80824 | 80825 | 80826 | 80827 |
| | beige bahama |  | 80832 | 80833 | 80834 | 80835 |
| | brown |  | 80836 | 80837 | 80838 | 80839 |

pack 20 pcs
euro/m

pack 80 pcs
euro/m









pack 100 pcs
euro/m

no partial packaging

to order the pack of 80 and 100 pcs, mark /80 or /100 after the article code (for example, code 80800 becomes 80800/100)

PROANGLE Q - OUTSIDE / INSIDE CORNERS / END CAPS

pack 12 pcs

| | | H | | | | |
|----------------------|----------------------|---|-------|-------|-------|-------|
| ART. | finishing | 6 | 8 | 10 | 12,5 | |
| POLYPROPYLENE | | | | | | |
| | white |  | 80850 | 80851 | 80852 | 80853 |
| | cream white RAL 9001 |  | 80854 | 80855 | 80856 | 80857 |
| | ivory RAL 1015 |  | 80858 | 80859 | 80860 | 80861 |
| | beige grey RAL 1019 |  | 80862 | 80863 | 80864 | 80865 |
| ZQP/ /EI | stone grey RAL 7030 |  | 80866 | 80867 | 80868 | 80869 |
| | light grey RAL 7035 |  | 80870 | 80871 | 80872 | 80873 |
| | anthracite |  | 80874 | 80875 | 80876 | 80877 |
| | beige bahama |  | 80882 | 80883 | 80884 | 80885 |
| | brown |  | 80886 | 80887 | 80888 | 80889 |

euro/pc

no partial packaging - pack of 50 pcs Euro

to order the pack of 50 pcs, mark /50 after the article code (for example, code 80850 becomes 80850/50)

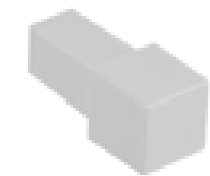

ZQP/ EI
white polypropylene

Complete the article code with H measure (for example ZQP/ for H=8 becomes ZQP/8)

Colours available on demand - minimum quantity 2700 meters

cerfix® proangle

Proangle in aluminium is a line of profiles for edging and protecting the external corners of ceramic coverings. Its L shape outlines clearly tile coverings, such as rectified porcelain stoneware.

Available in different colours and finishes, Proangle can also be used as decorative element, creating refined and pleasant combination/contrast effects with a wide variety of coverings.

ZQVNH/ boasts the certified antibacterial technology (in compliance with ISO 22196:2011 standards) which reduces the presence of the most dangerous bacteria up to 99%, thus assuring the best hygiene over time.



ZA/10 silver anodised aluminium

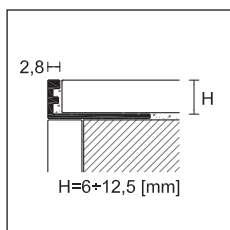
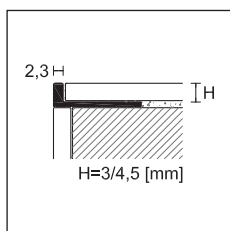

PROANGLE

length = 270 cm - pack 20 pcs

| | | H | | | | | | | | | |
|--|-----------------------------------|---|-------|-------|-------|-------|-------|-------|-------|-------|--|
| ART. | finishing | 3 | 4,5 | 6 | 8 | 9 | 10 | 11 | 12,5 | | |
| ALUMINIUM | | | | | | | | | | | |
| | silver anodised | | 90338 | 90340 | 88204 | 88205 | 88217 | 88206 | 88218 | 88207 | |
| | <i>euro/m</i> | | | | | | | | | | |
| ZA/ | titanium anodised | | - | - | 88253 | 88254 | - | 88255 | 88257 | 88256 | |
| | <i>euro/m</i> | | | | | | | | | | |
| | black anodised | | - | - | - | 88265 | - | 88266 | 88267 | 88268 | |
| | <i>euro/m</i> | | | | | | | | | | |
| ZB/ | bright polished silver | | - | 88260 | 88294 | 88295 | - | 88296 | 88220 | 88297 | |
| | <i>euro/m</i> | | | | | | | | | | |
| | bright polished gold | | - | 88261 | 88339 | 88340 | - | 88341 | - | 88342 | |
| ZB/ | bright polished titanium | | - | 88333 | 88334 | 88335 | - | 88336 | 88337 | 88338 | |
| | <i>euro/m</i> | | | | | | | | | | |
| ZBS/ | bright brushed silver | | - | - | - | - | - | 88356 | 88357 | 88358 | |
| ZTM/ | bright brushed titanium | | - | - | - | - | - | 88359 | 88360 | 88361 | |
| | <i>euro/m</i> | | | | | | | | | | |
| ZBS/ | bright brushed black | | - | - | - | - | - | 88353 | 88354 | 88355 | |
| | <i>euro/m</i> | | | | | | | | | | |
| COLOUR-COATED ALUMINIUM | | | | | | | | | | | |
| ZV/ | colour-coated matt white RAL 9003 | | - | - | - | 88395 | - | 88396 | 88435 | 88397 | |
| | colour-coated white RAL 9003 | | - | - | 88384 | 88385 | - | 88386 | 88436 | 88387 | |
| | <i>euro/m</i> | | | | | | | | | | |
| ANTIBACTERIAL COLOUR-COATED ALUMINIUM | | | | | | | | | | | |
| ZVH/ | colour-coated white RAL 9003 | | - | - | - | 88390 | - | 88392 | - | 88394 | |
| | <i>euro/m</i> | | | | | | | | | | |

individually packed

Complete the article code with H measure (for example ZA/ for H=8 becomes ZA/8)

Items ZV/ available in different colours on demand - minimum quantity 540 meters for colour.

Proangle: for different heights till 25 mm please see page 94-95

Items ZA-AI bendable version see page 96



ZA/10 black anodised aluminium



ZA/10 titanium anodised aluminium

Colour-coated aluminium Trend Color Stone: modern finishes with neutral but warm and soft shades which reproduce the heterogeneity of stone thanks to a rough texture.

Colour-coated aluminium Trend Color

Concrete: six original cement-effect finishes that recall the typical metropolis colours by revisiting them from a more refined point of view.

Colour-coated aluminium Trend Color

Metal: two special metal tonalities which reproduce the iridescent nature of metals.



ZV/10 beige colour-coated aluminium

PROANGLE - TREND COLOR

length = 270 cm - pack 20 pcs

H

| ART. | finishing | 8 | 10 | 11 | 12,5 |
|------|-----------|---|----|----|------|
|------|-----------|---|----|----|------|

COLOUR-COATED ALUMINIUM

TREND COLOR STONE

| | | | | | |
|-----------------|--|-------|-------|-------|-------|
| dark brown | | 88446 | 88407 | 88417 | 88481 |
| anthracite grey | | 88447 | 88398 | 88408 | 88482 |
| ancient grey | | 88448 | 88400 | 88410 | 88483 |
| grey | | 88449 | 88405 | 88415 | 88484 |
| rust | | 88450 | 88399 | 88409 | 88485 |
| bronze | | 88451 | 88406 | 88416 | 88486 |
| stone | | 88452 | 88404 | 88414 | 88491 |
| greige | | 88453 | 88403 | 88413 | 88492 |
| sand | | 88454 | 88402 | 88412 | 88493 |
| beige | | 88455 | 88401 | 88411 | 88494 |
| white stone | | 88456 | 88428 | 88433 | 88495 |
| ZV/ black stone | | 88457 | 88429 | 88434 | 88496 |

TREND COLOR CONCRETE

| | | | | | |
|-------------------|--|-------|-------|-------|-------|
| concrete white | | 88469 | 88437 | 88461 | 88497 |
| concrete graphite | | 88470 | 88438 | 88462 | 88498 |
| concrete smoke | | 88471 | 88439 | 88463 | 88499 |
| concrete mud | | 88472 | 88440 | 88464 | 88500 |
| concrete sand | | 88473 | 88441 | 88465 | 88501 |
| solid white | | 88478 | 88460 | 88468 | 88502 |

TREND COLOR METAL

| | | | | | |
|-------------|--|-------|-------|-------|-------|
| metal dark | | 88479 | 88458 | 88466 | 88503 |
| metal light | | 88480 | 88459 | 88467 | 88504 |

euro/m

individually packed

TREND COLOR

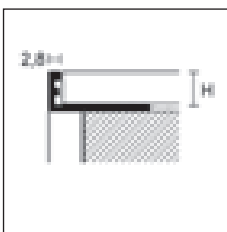

ZV/



ZV/10 white stone colour-coated aluminium

LED-light profiles and skirting boards with Trend Color finishes on page 228 and 232.

Complete the article code with H measure (for example ZV/ for H=10 becomes ZV/10).

Proangle in stainless steel is a line of profiles for edging and protecting the external corners of ceramic coverings. Its L shape outlines clearly tile coverings, such as rectified porcelain stoneware.

Stainless steel makes the profile particularly resistant to chemical and atmospheric agents. The AISI 316 DIN 1.4404 quality offers superior resistance to corrosion and is therefore recommended for applications in areas subject to greater chemical stress, such as swimming pools and food industries, and coastal areas.

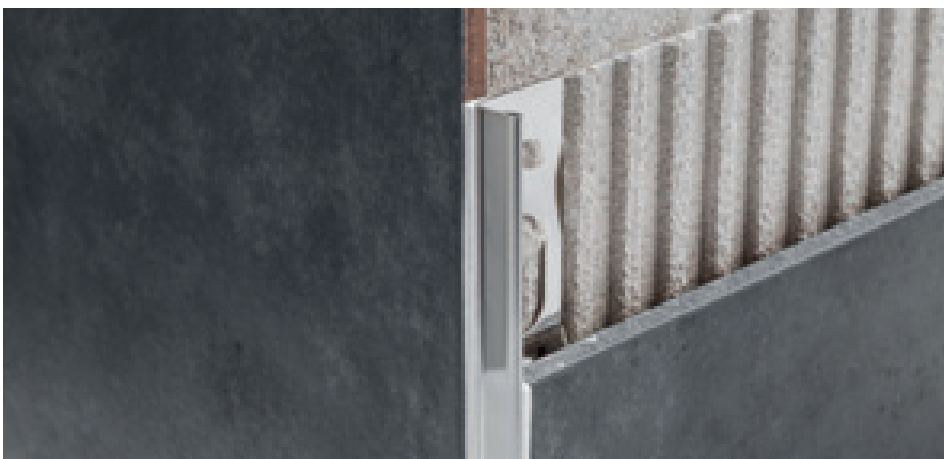

AI/10 stainless steel AISI 304 - DIN 1.4301

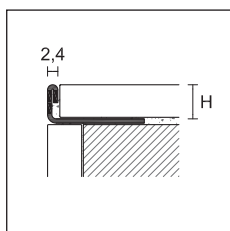

PROANGLE

length = 270 cm - pack 20 pcs

| | | H | | | | | | | | |
|------------------------|---|-------|-------|-------|-------|-------|-------|-------|-------|--|
| ART. | finishing | 3 | 4,5 | 6 | 8 | 9 | 10 | 11 | 12,5 | |
| STAINLESS STEEL | | | | | | | | | | |
| AI/ | stainless steel AISI 304 - DIN 1.4301 <i>euro/m</i> | 91636 | 91638 | 91642 | 91644 | 91645 | 91646 | 91647 | 91648 | |
| AIL/ | superpolished stainless steel AISI 304 - DIN 1.4301 <i>euro/m</i> | - | 91690 | - | 91694 | - | 91696 | - | 91698 | |
| AIS/ | brushed stainless steel AISI 304 - DIN 1.4301 <i>euro/m</i> | - | 91671 | 91673 | 91674 | - | 91675 | 91677 | 91676 | |
| AIP/ | sandblasted stainless steel AISI 304 - DIN 1.4301 <i>euro/m</i> | - | - | 91700 | 91702 | - | 91704 | 91705 | 91706 | |
| AIX/ | stainless steel AISI 316 - DIN 1.4404 <i>euro/m</i> | - | - | 91684 | 91685 | - | 91686 | 91688 | 91687 | |

individually packed

PROANGLE - OUTSIDE CORNER

pack 5 pcs

| | | H | | | | | | | | |
|------------------------|--|---|-----|---|---|---|-------|-------|-------|--|
| ART. | finishing | 3 | 4,5 | 6 | 8 | 9 | 10 | 11 | 12,5 | |
| STAINLESS STEEL | | | | | | | | | | |
| AI//E | stainless steel AISI 304 - DIN 1.4301 <i>euro/pc</i> | - | - | - | - | - | 91663 | 91664 | 91665 | |
| AIS//E | brushed stainless steel AISI 304 - DIN 1.4301 <i>euro/pc</i> | - | - | - | - | - | 91680 | 91681 | 91682 | |

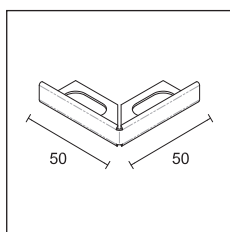

AI//E
AIS//E



AI//E stainless steel AISI 304 - DIN 1.4301

Complete the article code with H measure
(for example AI/ for H=10 becomes AI/10)

cerfix® proangle-prodecor

Proangle ZK and Prodecor DJK are two L-shaped profiles in chromium-plated brass, with different section, designed for edging and protecting the external corners of ceramic coverings. Chromium-plated brass stands out for its brilliance and is perfect as decorative element in spaces characterized by elegance and attention to details.



Proangle ZK/ chromium-plated brass

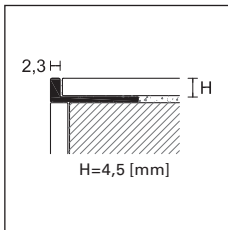

ZK/



PPDESIGN

PROANGLE

length = 270 cm - pack 20 pcs

| ART. | finishing | 4,5 | 6 | 8 | 9 | 10 | 11 | 12,5 |
|------|-----------|-----|---|---|---|----|----|------|
|------|-----------|-----|---|---|---|----|----|------|

CHROMIUM-PLATED BRASS

| | | | | | | | | | |
|-----|-----------------|--|-------|-------|-------|---|-------|-------|-------|
| ZK/ | chromium plated | | 90081 | 88114 | 88115 | - | 88116 | 88118 | 88117 |
| | euro/m | | | | | | | | |

individually packed

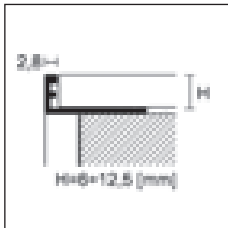

ZK/

PPDESIGN

PRODECOR DJ

length = 270 cm - pack 20 pcs

| ART. | finishing | 8 | 10 | 12,5 | 15 | 20 |
|------|-----------|---|----|------|----|----|
|------|-----------|---|----|------|----|----|

CHROMIUM-PLATED BRASS

| | | | | | | | |
|------|-----------------|--|-------|-------|-------|-------|-------|
| DJK/ | chromium plated | | 95700 | 95702 | 95704 | 95703 | 95705 |
| | euro/m | | | | | | |

individually packed - art. DJK/20 pack 10 pcs

PRODECOR DJ - OUTSIDE AND INSIDE CORNERS

pack 5 pcs

| ART. | finishing | 8 | 10 | 12,5 | 15 | 20 |
|------|-----------|---|----|------|----|----|
|------|-----------|---|----|------|----|----|

CHROMIUM-PLATED BRASS

| | | | | | | | |
|----------|-----------------|--|-------|-------|-------|-------|-------|
| DJK/ /EI | chromium plated | | 95706 | 95707 | 95708 | 95709 | 95710 |
| | euro/pc | | | | | | |

no partial packaging

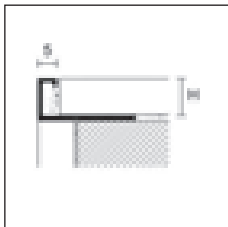

DJK/



DJK/ /EI



Prodecor DJK/ chromium-plated brass

Complete the article code with H measure (for example ZK/ for H=8 becomes ZK/8)

external corners profiles

cerfix® proangle

Proangle in PVC is a line of profiles for edging and protecting the external corners of ceramic coverings. Its L shape outlines clearly tile coverings, such as rectified porcelain stoneware. Available in many different colours, they can be used in the most varied spaces.



PV/8 beige grey PVC

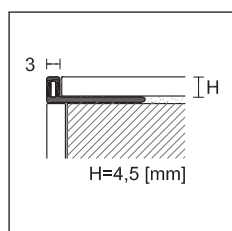

PV/



PROANGLE

length = 270 cm

| | | H | | | | | |
|------------|----------------------|-----|-------|-------|-------|-------|-------|
| ART. | finishing | 4,5 | 6 | 8 | 10 | 12,5 | |
| PVC | | | | | | | |
| | snow white | | 80610 | 80496 | 80497 | 80498 | 80499 |
| | white | | 80611 | 80500 | 80501 | 80502 | 80503 |
| | cream white RAL 9001 | | - | 80504 | 80505 | 80506 | 80507 |
| | ivory RAL 1015 | | - | 80508 | 80509 | 80510 | - |
| | beige grey RAL 1019 | | - | 80512 | 80513 | 80514 | - |
| PV/ | beige bahama | | - | 80552 | 80553 | 80554 | - |
| | stone grey RAL 7030 | | - | 80516 | 80517 | 80518 | - |
| | ash grey RAL 7038 | | - | 80520 | 80521 | 80522 | - |
| | light grey RAL 7035 | | - | 80524 | 80525 | 80526 | 80527 |
| | anthracite | | - | 80559 | 80560 | 80561 | - |
| | red RAL 3002 | | - | 80528 | 80529 | 80530 | - |
| | black RAL 9005 | | - | 80532 | 80533 | 80534 | - |

pack 20 pcs

euro/m

pack 100 pcs

euro/m

no partial packaging

to order the pack of 100 pcs, mark /100 after article code (for example code 80497 becomes 80497/100)

Complete the article code with H measure (for example PV/ for H=8 becomes PV/8)

Items PV/ available in different colours on demand - minimum quantity 2700 meters for colour

Protrim IP are minimalist profiles in aluminium or stainless steel, suitable for the edging of external corners that need the 45 degrees cut. These profiles allow a perfect installation both on wall coverings and on stairs or platforms in ceramic or wood.



IPA/11 silver anodised aluminium



IPI/11 stainless steel AISI 304 - DIN 1.4301

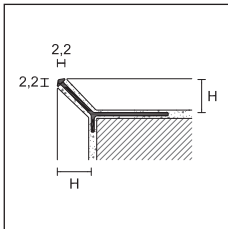

IPA/
IPB/
IPV/



TREND
COLOR



IPV/11 beige colour-coated aluminium

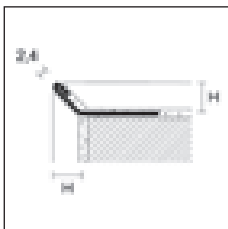

IPV/

PROTRIM IP

length = 270 cm - pack 20 pcs

| ART. | finishing | | 4,5 | 8 | 11 | 15 |
|------------------|------------------------|--|-------|-------|-------|-------|
| ALUMINIUM | | | | | | |
| IPA/ | silver anodised | | 95006 | 95178 | 95181 | 95185 |
| | <i>euro/m</i> | | | | | |
| IPB/ | bright polished silver | | 95008 | - | - | - |
| | <i>euro/m</i> | | | | | |

individually packed

PROTRIM IP - TREND COLOR STONE

length = 270 cm - pack 20 pcs

| ART. | finishing | | 11 |
|--------------------------------|-----------|--|----|
| COLOUR-COATED ALUMINIUM | | | |

TREND COLOR STONE

| | | |
|------------------|--|-------|
| dark brown | | 95182 |
| anthracite grey | | 95183 |
| ancient grey | | 95184 |
| grey | | 95186 |
| rust | | 95187 |
| bronze | | 95188 |
| stone | | 95189 |
| greige | | 95190 |
| sand | | 95191 |
| beige | | 95192 |
| IPV/ white stone | | 95193 |
| black stone | | 95194 |

NEW TREND COLOR CONCRETE

| | | |
|-------------------|--|-------|
| concrete white | | 95195 |
| concrete graphite | | 95196 |
| concrete smoke | | 95197 |
| concrete mud | | 95198 |
| concrete sand | | 95199 |
| solid white | | 95205 |

NEW TREND COLOR METAL

| | | |
|-------------|--|-------|
| metal dark | | 95206 |
| metal light | | 95217 |

euro/m

individually packed - Other heights with TREND COLOR finishes are available upon request, with a minimum of 540 meters.

PROTRIM IP

length = 270 cm - pack 20 pcs

| ART. | finishing | | 7 | 8 | 11 | 12,5 |
|------------------------|---------------------------------------|--|-------|-------|-------|-------|
| STAINLESS STEEL | | | | | | |
| IPI/ | stainless steel AISI 304 - DIN 1.4301 | | 95169 | 95170 | 95173 | 95174 |
| | <i>euro/m</i> | | | | | |

individually packed

Complete the article code with H measure (es: IPA/ for H=10 becomes IPA/10)

Protrim in aluminium is a line of profiles with rounded shape, specially designed to edge and protect the external corners of ceramic coverings. Their shape also acts as symmetric finishing and helps preventing accidents.

RVH/ boasts the certified antibacterial technology (in compliance with ISO 22196:2011 standards) which reduces the presence of the most dangerous bacteria up to 99%, thus assuring the best hygiene over time.



RA/10 silver anodised aluminium

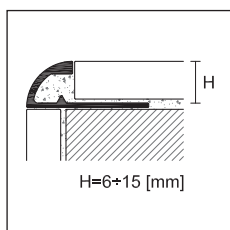
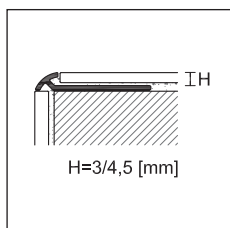

PROTRIM

length = 270 cm - pack 20 pcs

| | | H | | | | | | | | |
|--|---|---|-------|-------|-------|-------|-------|-------|-------|-------|
| ART. | finishing | 3 | 4,5 | 6 | 8 | 10 | 11 | 12,5 | 15 | |
| ALUMINIUM | | | | | | | | | | |
| RA/ | silver anodised <i>euro/m</i> | | 92055 | 92056 | 92070 | 92072 | 92074 | 92060 | 92076 | 92078 |
| | gold anodised <i>euro/m</i> | | 92025 | 92026 | 92040 | 92042 | 92044 | - | 92046 | - |
| | titanium anodised <i>euro/m</i> | | 92085 | 92086 | 92087 | 92090 | 92094 | - | 92096 | - |
| RB/ | bright polished silver <i>euro/m</i> | | 92315 | 92316 | 92310 | 92312 | 92314 | 92061 | 92318 | - |
| | bright polished gold <i>euro/m</i> | | 92325 | 92326 | 92340 | 92342 | 92344 | - | 92348 | - |
| RB/ | bright polished titanium <i>euro/m</i> | | - | - | - | 92029 | 92031 | - | 92032 | - |
| | bright brushed silver <i>euro/m</i> | | 92050 | 92051 | 92071 | 92073 | 92075 | 92062 | 92077 | - |
| RAS/ | bright brushed gold <i>euro/m</i> | | - | - | 92041 | 92043 | 92045 | - | 92047 | - |
| RTM/ | bright brushed titanium <i>euro/m</i> | | 92053 | 92057 | 92064 | 92066 | 92068 | - | 92079 | - |
| COLOUR-COATED ALUMINIUM | | | | | | | | | | |
| RV/ | matt white RAL 9003 <i>euro/m</i> | | - | - | - | 92107 | 92108 | 92109 | 92110 | - |
| | white RAL 9003 <i>euro/m</i> | | - | - | 92100 | 92102 | 92104 | 92111 | 92106 | - |
| ANTIBACTERIAL COLOUR-COATED ALUMINIUM | | | | | | | | | | |
| RVH/ | white RAL 9003 <i>euro/m</i> | | - | - | - | 92112 | 92114 | - | 92116 | - |

individually packed











Complete the article code with H measure (for example RA/ for H=8 becomes RA/8)

Items RV/ available in different colours on demand - minimum quantity 540 meters for colour













RAS/10 bright brushed silver aluminium

TA/ silver
anodised
aluminium**PROTRIM - OUTSIDE CORNER**

| pack 5 pcs | | H | | | | | |
|--------------------------------|--------------------------|---|-------|-------|-------|-------|-------|
| ART. | finishing | 6 | 8 | 10 | 11 | 12,5 | |
| ALUMINIUM | | | | | | | |
| TA/ | silver anodised |  | 92606 | 92608 | 92610 | 92600 | 92612 |
| | gold anodised |  | 92614 | 92616 | 92618 | - | 92619 |
| | titanium anodised |  | 92564 | 92566 | 92568 | - | 92569 |
| <i>euro/pc</i> | | | | | | | |
| TB/ | bright polished silver |  | 92690 | 92692 | 92694 | 92601 | 92696 |
| | bright polished gold |  | 92700 | 92702 | 92704 | - | 92706 |
| | bright polished titanium |  | - | 92727 | 92731 | - | 92733 |
| <i>euro/pc</i> | | | | | | | |
| TAS/ | bright brushed silver |  | 92710 | 92711 | 92712 | 92602 | 92713 |
| | bright brushed gold |  | 92720 | 92721 | 92722 | - | 92723 |
| TATM/ | bright brushed titanium |  | 92714 | 92716 | 92718 | - | 92773 |
| <i>euro/pc</i> | | | | | | | |
| COLOUR-COATED ALUMINIUM | | | | | | | |
| TV/ | matt white RAL 9003 |  | - | 92636 | 92637 | 92638 | 92639 |
| | white RAL 9003 |  | 92620 | 92622 | 92624 | 92628 | 92626 |
| <i>euro/pc</i> | | | | | | | |

no partial packaging

PROTRIM - INSIDE CORNER

| pack 5 pcs | | H | | | | | |
|--------------------------------|--------------------------|---|-------|-------|-------|-------|-------|
| ART. | finishing | 6 | 8 | 10 | 11 | 12,5 | |
| ALUMINIUM | | | | | | | |
| TIA/ | silver anodised |  | 92570 | 92571 | 92572 | 92603 | 92573 |
| | gold anodised |  | 92575 | 92576 | 92577 | - | 92578 |
| | titanium anodised |  | 92554 | 92555 | 92556 | - | 92558 |
| <i>euro/pc</i> | | | | | | | |
| TIB/ | bright polished silver |  | 92580 | 92581 | 92582 | 92604 | 92583 |
| | bright polished gold |  | 92585 | 92586 | 92587 | - | 92588 |
| | bright polished titanium |  | - | 92746 | 92747 | - | 92748 |
| <i>euro/pc</i> | | | | | | | |
| TIAS/ | bright brushed silver |  | 92550 | 92551 | 92552 | 92605 | 92553 |
| | bright brushed gold |  | 92560 | 92561 | 92562 | - | 92563 |
| <i>euro/pc</i> | | | | | | | |
| COLOUR-COATED ALUMINIUM | | | | | | | |
| TIV/ | matt white RAL 9003 |  | - | 92646 | 92647 | 92648 | 92649 |
| | white RAL 9003 |  | 92621 | 92623 | 92625 | 92629 | 92627 |
| <i>euro/pc</i> | | | | | | | |

no partial packaging

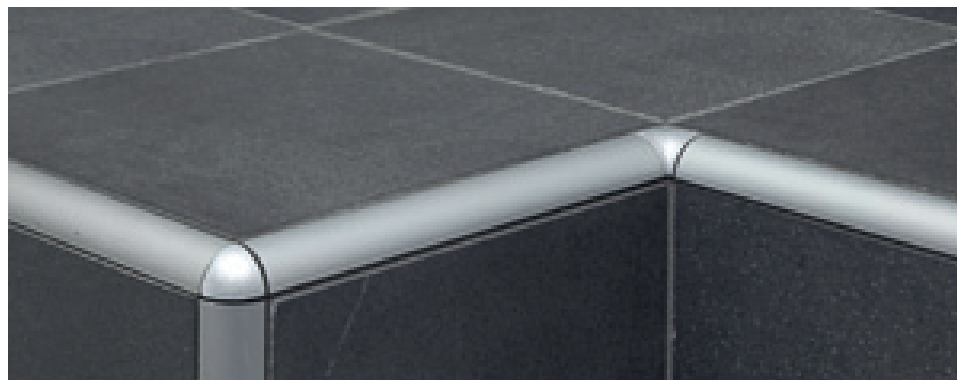
TIA/ silver
anodised
aluminiumComplete the article code with H measure
(for example TA/ for H=8 becomes TA/8)

RA/10+TA/10+TIA/10 silver anodised aluminium

cerfix® protrim

Protrim in stainless steel is a line of profiles with rounded shape, specially designed to edge and protect the external corners of ceramic coverings and also recommended for floors, steps, worktops and platforms.

The AISI 304 versions are recommended for food industries, kitchens, hospitals and outdoor spaces, while the AISI 316 versions are suggested in case of difficult applications, such as swimming pools, spas and places exposed to salt.



RI/10 stainless steel AISI 304 DIN 1.4301

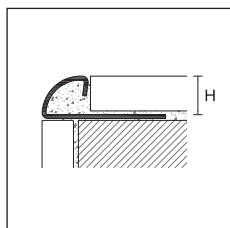

PROTRIM

length = 270 cm - pack 20 pcs

| | | H | | | | | | | | |
|------------------------|--|-----|-------|-------|-------|-------|-------|-------|-------|-------|
| ART. | finishing | 4,5 | 6 | 8 | 9 | 10 | 11 | 12,5 | 15 | |
| STAINLESS STEEL | | | | | | | | | | |
| RI/ | stainless steel AISI 304 DIN 1.4301 | | 92413 | 92420 | 92422 | 92423 | 92424 | 92425 | 92426 | 92428 |
| | euro/m | | | | | | | | | |
| RIS/ | brushed stainless steel AISI 304 - DIN 1.4301 | | - | 92430 | 92431 | 92438 | 92432 | 92439 | 92433 | 92434 |
| | euro/m | | - | | | | | | | |
| RIP/ | sandblasted stainless steel AISI 304 - DIN 1.4301 | | - | 92450 | 92451 | 92452 | 92453 | 92454 | 92455 | - |
| | euro/m | | - | | | | | | | - |
| RIX/ | stainless steel AISI 316 - DIN 1.4404 | | 92405 | 92406 | 92407 | 92410 | 92408 | 92411 | 92409 | - |
| | euro/m | | | | | | | | | - |

individually packed - art. RI/15 pack 10 pcs

PROTRIM - OUTSIDE CORNER - pack 5 pcs

| | | | | | | | | | | |
|-------|--|--|-------|-------|-------|-------|-------|-------|-------|-------|
| TIE/ | stainless steel AISI 304 - DIN 1.4301 | | 92750 | 92480 | 92481 | 92751 | 92482 | 92752 | 92483 | 92484 |
| | euro/pc | | | | | | | | | |
| TIES/ | brushed stainless steel AISI 304 - DIN 1.4301 | | - | 92485 | 92486 | 92753 | 92487 | 92754 | 92488 | 92489 |
| | euro/pc | | - | | | | | | | |
| TIEP/ | sandblasted stainless steel AISI 304 - DIN 1.4301 | | - | 92510 | 92511 | 92512 | 92513 | 92514 | 92515 | - |
| | euro/pc | | - | | | | | | | - |
| TIEX/ | stainless steel AISI 316 - DIN 1.4404 | | 92500 | 92501 | 92502 | 92755 | 92503 | 92756 | 92504 | - |
| | euro/pc | | | | | | | | | - |

PROTRIM - INSIDE CORNER - pack 5 pcs

| | | | | | | | | | | |
|-------|--|--|-------|-------|-------|-------|-------|-------|-------|-------|
| TII/ | stainless steel AISI 304 - DIN 1.4301 | | 92759 | 92490 | 92491 | 92757 | 92492 | 92758 | 92493 | 92494 |
| | euro/pc | | | | | | | | | |
| TIIS/ | brushed stainless steel AISI 304 - DIN 1.4301 | | - | 92495 | 92496 | 92760 | 92497 | 92761 | 92498 | 92499 |
| | euro/pc | | - | | | | | | | |
| TIIP/ | sandblasted stainless steel AISI 304 - DIN 1.4301 | | - | 92516 | 92517 | 92518 | 92519 | 92520 | 92521 | - |
| | euro/pc | | - | | | | | | | - |
| TIIX/ | stainless steel AISI 316 - DIN 1.4404 | | 92505 | 92506 | 92507 | 92762 | 92508 | 92763 | 92509 | - |
| | euro/pc | | | | | | | | | - |

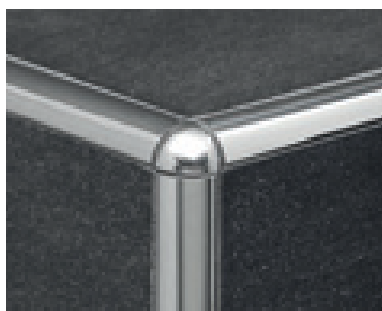

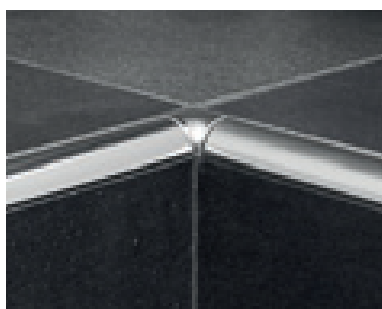

RI/10 + TIE/10 stainless steel AISI 304 DIN 1.4301



RI/10 + TII/10 stainless steel AISI 304 DIN 1.4301

Complete the article code with H measure
(for example RI/ for H=8 becomes RI/8)

| METAL | | 8 | 10 | 11 |
|-----------------------------|--------------------------|---|-------|-------|
| OUTSIDE CORNER - pack 5 pcs | | | | |
| TIME/ | polished stainless steel |  | - | - |
| | <i>euro/pc</i> | 92960 | 92964 | 92966 |
| | | - | - | - |
| INSIDE CORNER - pack 5 pcs | | | | |
| TIMI/ | polished stainless steel |  | - | - |
| | <i>euro/pc</i> | 92970 | 92974 | 92976 |
| | | - | - | - |

no partial packaging



RIN/10 stainless steel AISI 304 - DIN 1.4301

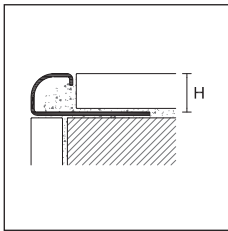



RIN/
RINS/
RINX/



PROTRIM N

length = 270 cm - pack 20 pcs

| ART. | finishing | | 8 | 10 | 12,5 |
|------------------------|--|---|-------|-------|-------|
| STAINLESS STEEL | | | | | |
| RIN/ | stainless steel AISI 304 - DIN 1.4301 |  | 92353 | 92356 | 92359 |
| | <i>euro/m</i> | | | | |
| RINS/ | brushed stainless steel AISI 304 - DIN 1.4301 |  | 92354 | 92357 | 92360 |
| | <i>euro/m</i> | | | | |
| RINX/ | stainless steel AISI 316 - DIN 1.4404 |  | 92355 | 92358 | 92361 |
| | <i>euro/m</i> | | | | |

individually packed





TIEN/ stainless
steel AISI 304 -
DIN 1.4301





TIENX/ stainless
steel AISI 304 -
DIN 1.4301

PROTRIM N - OUTSIDE CORNER - pack 5 pcs

| | | | | | |
|---------------|--|---|-------|-------|-------|
| TIEN/ | stainless steel AISI 304 - DIN 1.4301 |  | 92813 | 92816 | 92819 |
| | <i>euro/pc</i> | | | | |
| TIENS/ | brushed stainless steel AISI 304 - DIN 1.4301 |  | 92814 | 92817 | 92820 |
| | <i>euro/pc</i> | | | | |
| TIENX/ | stainless steel AISI 316 - DIN 1.4404 |  | 92815 | 92818 | 92821 |
| | <i>euro/pc</i> | | | | |

PROTRIM N - INSIDE CORNER - pack 5 pcs

| | | | | | |
|---------------|--|---|-------|-------|-------|
| TIIN/ | stainless steel AISI 304 - DIN 1.4301 |  | 92828 | 92831 | 92834 |
| | <i>euro/pc</i> | | | | |
| TIINS/ | brushed stainless steel AISI 304 - DIN 1.4301 |  | 92829 | 92832 | 92835 |
| | <i>euro/pc</i> | | | | |
| TIINX/ | stainless steel AISI 316 - DIN 1.4404 |  | 92830 | 92833 | 92836 |
| | <i>euro/pc</i> | | | | |

Complete the article code with H measure
(for example RIN/ for H=8 becomes RIN/8)

cerfix® protrim

Protrim in polished brass is classic and modern at the same time and can be easily combined to handles, taps and other furniture accessories of the same material and finish.

The chromium-plated version stands out for its brilliance and is perfect as decorative element in spaces characterized by elegance and attention to details.



RKN/10 chromium-plated brass

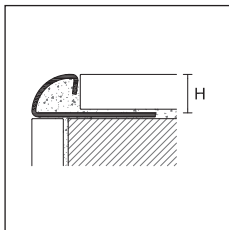



RLN/
RKN/



PPDESIGN

PROTRIM



length = 270 cm - pack 20 pcs

| | | H | | | | |
|------------------------------|-----------------|---|-------|-------|-------|-------|
| ART. | finishing | 6 | 8 | 10 | 12,5 | |
| POLISHED BRASS | | | | | | |
| RLN/ | polished |  | 92465 | 92466 | 92467 | 92468 |
| | | <i>euro/m</i> | | | | |
| CHROMIUM-PLATED BRASS | | | | | | |
| RKN/ | chromium plated |  | 92469 | 92470 | 92471 | 92472 |
| | | <i>euro/m</i> | | | | |

individually packed - art. RLN/10, RLN/12,5, RKN/10, RKN/12,5 packaging of 10 pcs

PROTRIM - OUTSIDE / INSIDE CORNERS

pack 5 pcs



| | | H | | | | |
|-----------------------------------|----------------------|---|-------|-------|-------|-------|
| ART. | finishing | 6 | 8 | 10 | 12,5 | |
| OUTSIDE CORNERS FOR RLN/ ARTICLES | | | | | | |
| ALUMINIUM | | | | | | |
| TB/ | bright polished gold |  | 92700 | 92702 | 92704 | 92706 |
| | | <i>euro/pc</i> | | | | |
| INSIDE CORNERS FOR RLN/ ARTICLES | | | | | | |
| ALUMINIUM | | | | | | |
| TIB/ | bright polished gold |  | 92585 | 92586 | 92587 | 92588 |
| | | <i>euro/pc</i> | | | | |

no partial packaging

pack 5 pcs

OUTSIDE CORNERS IN SUPERPOLISHED STAINLESS STEEL FOR RKN/ ITEMS

STAINLESS STEEL

| | | | | | | |
|--|--|---|-------|-------|-------|-------|
| TIEL/ | superpolished stainless steel AISI 304 DIN 1.4301 |  | 92792 | 92794 | 92798 | 92802 |
| | | <i>euro/pc</i> | | | | |
| INSIDE CORNERS IN SUPERPOLISHED STAINLESS STEEL FOR RKN/ ITEMS | | | | | | |
| STAINLESS STEEL | | | | | | |
| TIIL/ | superpolished stainless steel AISI 304 DIN 1.4301 |  | 92793 | 92795 | 92799 | 92803 |
| | | <i>euro/pc</i> | | | | |



TIEL/



TIIL/

Complete the article code with H measure
(for example RLN/ for H=8 becomes RLN/8)

Protrim in coextruded PVC is a line of profiles with rounded shape, specially designed to edge and protect the external corners of ceramic coverings. Their shape also acts as symmetric finishing and helps preventing accidents. Thanks to the special section with soft PVC inserts, these profiles absorb the micro-movements that discharge on the corner due to the tension of the wall coverings. Mass-dye coloured, they are available in many different colours and can be used in the most varied spaces.



RPA/8 white co-extruded PVC

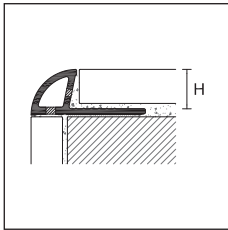

RPA/



PROTRIM

length = 270 cm - pack 20/100 pcs

| | | H | | |
|------|----------------------|-----------------|-------|-------|
| | | CO-EXTRUDED PVC | | |
| ART. | finishing | 6 | 8 | 10 |
| | snow white | 80640 | 80641 | 80642 |
| | white | 80644 | 80645 | 80646 |
| | cream white RAL 9001 | 80648 | 80649 | 80650 |
| | ivory RAL 1015 | 80652 | 80653 | 80654 |
| RPA/ | beige grey RAL 1019 | 80656 | 80657 | 80658 |
| | stone grey RAL 7030 | 80660 | 80661 | 80662 |
| | ash grey RAL 7038 | 80664 | 80665 | 80666 |
| | light grey RAL 7035 | 80668 | 80669 | 80670 |
| | beige bahama | 80680 | 80681 | 80682 |
| | brown | 80692 | 80693 | 80694 |

pack 20 pcs
euro/m

pack 100 pcs
euro/m

no partial packaging

To order profiles in packs of 100 pcs, mark /100 after article code (for example code 80640 becomes 80640/100)

PROTRIM

pack 12 pcs

| | | H | | | | | |
|----------------------|--|----------------|-------|-------|---------------|-------|-------|
| | | TPAE/ | | | TPAI/ | | |
| | | POLYPROPYLENE | | | | | |
| | | OUTSIDE CORNER | | | INSIDE CORNER | | |
| finishing | | 6 | 8 | 10 | 6 | 8 | 10 |
| snow white | | 80700 | 80701 | 80702 | 80753 | 80751 | 80752 |
| white | | 80703 | 80704 | 80705 | 80750 | 80754 | 80755 |
| cream white RAL 9001 | | 80706 | 80707 | 80708 | 80756 | 80757 | 80758 |
| ivory RAL 1015 | | 80709 | 80710 | 80711 | 80759 | 80760 | 80761 |
| beige grey RAL 1019 | | 80712 | 80713 | 80714 | 80762 | 80763 | 80764 |
| stone grey RAL 7030 | | 80715 | 80716 | 80717 | 80765 | 80766 | 80767 |
| ash grey RAL 7038 | | 80718 | 80719 | 80720 | 80768 | 80769 | 80770 |
| light grey RAL 7035 | | 80721 | 80722 | 80723 | 80771 | 80772 | 80773 |
| beige bahama | | 80730 | 80731 | 80732 | 80780 | 80781 | 80782 |
| brown | | 80739 | 80740 | 80741 | 80789 | 80790 | 80791 |

euro/pc

To order corners in packs of 50 pcs, mark /50 after article code (for example code 80700 becomes 80700/50) - pack of 50 pcs Euro

Complete the article code with H measure (for example RPA/ for H=8 becomes RPA/8)

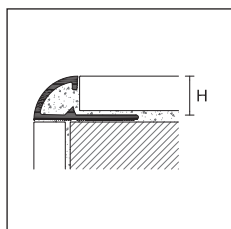

RE/

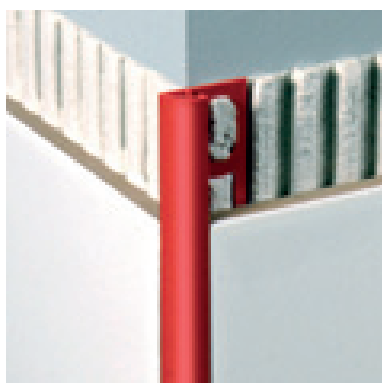

RE/8 PVC red RAL 3002

PROTRIM

lengt = 270 cm - pack 20/100 pcs

| | | H | | | | |
|------|----------------------|-----|-------|-------|-------|-------|
| | | PVC | | | | |
| ART. | finishing | 6 | 8 | 10 | 12,5 | |
| | snow white | ☐ | 79996 | 79997 | 79998 | 79999 |
| | white | ☐ | 80100 | 80101 | 80102 | 80103 |
| | cream white RAL 9001 | ☐ | 80104 | 80105 | 80106 | 80107 |
| | ivory RAL 1015 | ☐ | 80108 | 80109 | 80110 | - |
| | beige grey RAL 1019 | ☐ | 80112 | 80113 | 80114 | - |
| | stone grey RAL 7030 | ☐ | 80116 | 80117 | 80118 | - |
| | ash grey RAL 7038 | ☐ | 80120 | 80121 | 80122 | - |
| | light grey RAL 7035 | ☐ | 80124 | 80125 | 80126 | 80127 |
| | anthracite | ☐ | 80175 | 80176 | 80177 | - |
| | blue | ☐ | 80160 | 80161 | 80162 | - |
| | pastel blue | ☐ | 80140 | 80141 | 80142 | - |
| RE/ | light green | ☐ | 80179 | 80180 | 80181 | - |
| | red RAL 3002 | ☐ | 80128 | 80129 | 80130 | - |
| | black RAL 9005 | ☐ | 80132 | 80133 | 80134 | - |
| | yellow RAL 1023 | ☐ | 80136 | 80137 | 80138 | - |
| | pastel pink | ☐ | 80144 | 80145 | 80146 | - |
| | beige bahama | ☐ | 80150 | 80151 | 80152 | - |
| | peach | ☐ | 80154 | 80155 | 80156 | - |
| | caramel | ☐ | 80164 | 80165 | 80166 | - |
| | brown | ☐ | 80168 | 80169 | 80170 | - |
| | dark brown | ☐ | 80172 | 80173 | 80174 | - |
| | coral red | ☐ | 80187 | 80188 | 80189 | - |
| | raw sienna | ☐ | 80191 | 80192 | 80193 | - |
| | terracotta | ☐ | 80195 | 80362 | 80194 | - |

pack 20 pcs - euro/m

pack 100 pcs - euro/m

no partial packaging - to order the pack of 100 pcs, mark /100 after article code

Complete the article code with H measure (for example RE/ for H=8 becomes RE/8)

PROTRIM

pack 12 pcs

| | | H | | | | H | | | | |
|------|----------------------|----------------|-------|-------|-------|---------------|-------|-------|-------|-------|
| | | TE/ | | | | TE/ | | | | |
| | | POLYPROPYLENE | | | | | | | | |
| | | OUTSIDE CORNER | | | | INSIDE CORNER | | | | |
| ART. | finishing | 6 | 8 | 10 | 12,5 | 6 | 8 | 10 | 12,5 | |
| | snow white | ☐ | 80396 | 80397 | 80398 | 80399 | 79800 | 79801 | 79802 | 79803 |
| | white | ☐ | 80400 | 80401 | 80402 | 80403 | 79804 | 79805 | 79806 | 79807 |
| | cream white RAL 9001 | ☐ | 80404 | 80405 | 80406 | 80407 | 79808 | 79809 | 79810 | 79811 |
| | ivory RAL 1015 | ☐ | 80408 | 80409 | 80410 | - | 79812 | 79813 | 79814 | - |
| | beige grey RAL 1019 | ☐ | 80412 | 80413 | 80414 | - | 79816 | 79817 | 79818 | - |
| | stone grey RAL 7030 | ☐ | 80416 | 80417 | 80418 | - | 79820 | 79821 | 79822 | - |
| | ash grey RAL 7038 | ☐ | 80420 | 80421 | 80422 | - | 79824 | 79825 | 79826 | - |
| | light grey RAL 7035 | ☐ | 80424 | 80425 | 80426 | 80427 | 79828 | 79829 | 79830 | 79831 |
| | anthracite | ☐ | 80479 | 80480 | 80481 | - | 79875 | 79876 | 79877 | - |
| | blue | ☐ | 80470 | 80471 | 80472 | - | 79848 | 79849 | 79850 | - |
| | pastel blue | ☐ | 80440 | 80441 | 80442 | - | 79844 | 79845 | 79846 | - |
| | light green | ☐ | 80475 | 80476 | 80477 | - | 79879 | 79880 | 79881 | - |
| | red RAL 3002 | ☐ | 80428 | 80429 | 80430 | - | 79832 | 79833 | 79834 | - |
| | black RAL 9005 | ☐ | 80432 | 80433 | 80434 | - | 79836 | 79837 | 79838 | - |
| | yellow RAL 1023 | ☐ | 80436 | 80437 | 80438 | - | 79840 | 79841 | 79842 | - |
| | pastel pink | ☐ | 80444 | 80445 | 80446 | - | 79852 | 79853 | 79854 | - |
| | beige bahama | ☐ | 80448 | 80449 | 80450 | - | 79856 | 79857 | 79858 | - |
| | peach | ☐ | 80452 | 80453 | 80454 | - | 79860 | 79861 | 79862 | - |
| | caramel | ☐ | 80458 | 80459 | 80460 | - | 79864 | 79865 | 79866 | - |
| | brown | ☐ | 80462 | 80463 | 80464 | - | 79868 | 79869 | 79870 | - |
| | dark brown | ☐ | 80466 | 80467 | 80468 | - | 79872 | 79873 | 79874 | - |
| | coral red | ☐ | 80483 | 80484 | 80485 | - | 79887 | 79888 | 79889 | - |
| | raw sienna | ☐ | 80487 | 80488 | 80489 | - | 79891 | 79892 | 79893 | - |
| | terracotta | ☐ | 80491 | 80492 | 80493 | - | 79895 | 79896 | 79897 | - |

euro/pc

no partial packaging

To order corners in packs of 50 pcs, mark /50 after article code (for example code 80396 becomes 80396/50) pack of 50 pcs. €/pcs

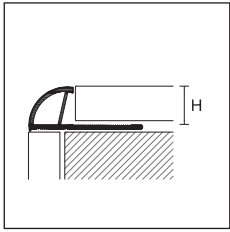

RECO/

PROTRIM ECO

length = 260 cm - pack 80 pcs

| ART. | finishing | ECOLINE PVC | | | |
|------------------|----------------------|-------------|-------|-------|-------|
| | | 6 | 8 | 10 | |
| | snow white | | 79400 | 79401 | 79402 |
| | white | | 79403 | 79404 | 79405 |
| | cream white RAL 9001 | | 79406 | 79407 | 79408 |
| RECO/ /80 | ivory RAL 1015 | | 79409 | 79410 | 79411 |
| | ash grey RAL 7038 | | 79412 | 79413 | 79414 |
| | light grey RAL 7035 | | 79415 | 79416 | 79417 |
| | beige bahama | | 79418 | 79419 | 79420 |
| | euro/m | | | | |

no partial packaging

others colour on request for minimum 2600 mt for colour

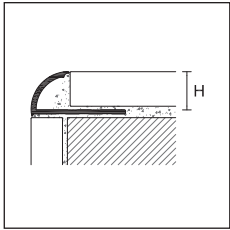

REC/

PROTRIM ECO

length = 260 cm - pack 100 pcs

| ART. | finishing | ECOLINE PVC | | | |
|------------------|----------------------|-------------|---|-----------|-----------|
| | | - | 8 | 10 | |
| | snow white | | - | 79601/100 | 79602/100 |
| | cream white RAL 9001 | | - | 79605/100 | 79606/100 |
| | ivory RAL 1015 | | - | - | 79610/100 |
| | beige grey RAL 1019 | | - | - | 79614/100 |
| REC/ /100 | stone grey RAL 7030 | | - | - | 79618/100 |
| | ash grey RAL 7038 | | - | - | 79622/100 |
| | light grey RAL 7035 | | - | - | 79626/100 |
| | beige bahama | | - | - | 79642/100 |
| | euro/m | | - | | |

no partial packaging

others colour on request for minimum 2600 mt for colour



REC/10 white PVC ecoline

Complete the article code with H measure
(for example REC/ /100 for H=8 becomes
REC/8/100)

cerfix® proangle F

Proangle F is a triangular profile indicated as a decorative element and closing of the outside corners of the tiles.

The stainless steel version with reduced base is rather suitable for the protection and finishing of the interior angles of ceramic coverings.



FMB/10 + FMBE/10 bright polished silver aluminium

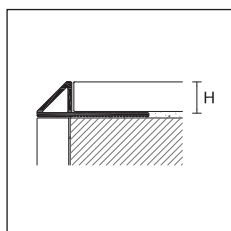

FMA/
FMB/



PROANGLE F

length = 270 cm - pack 20 pcs

| ART. finishing | | H | | | |
|------------------|---|---|-------|-------|-------|
| | | 8 | 10 | 12,5 | |
| ALUMINIUM | | | | | |
| FMA/ | silver anodised <i>euro/m</i> | | 93025 | 93026 | 93027 |
| FMB/ | bright polished silver <i>euro/m</i> | | 93028 | 93029 | 93030 |

individually packed

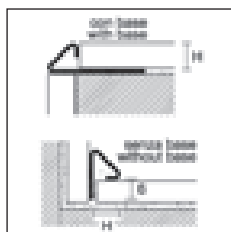

FMI/
FMIS/

PROANGLE F

length = 270 cm - pack 20 pcs

| ART. finishing | | H | | | | |
|------------------------|---|-----------|--------------|-----------|--------------|-------|
| | | 8 | | 10 | | |
| STAINLESS STEEL | | | | | | |
| | | with base | without base | with base | without base | |
| FMI/ | stainless steel AISI 304 - DIN 1.4301 <i>euro/m</i> | | 93050 | 93051 | 93052 | 93053 |
| FMIS/ | brushed stainless steel AISI 304 - DIN 1.4301 <i>euro/m</i> | | 93054 | 93055 | 93056 | 93057 |

individually packed

OUTSIDE CORNER

| pack 5 pcs | | H | | | |
|------------------|--|---|-------|-------|-------|
| ART. finishing | | 8 | 10 | 12,5 | |
| ALUMINIUM | | | | | |
| FMAE/ | silver anodised <i>euro/pc</i> | | 93031 | 93032 | 93033 |
| FMBE/ | bright polished silver <i>euro/pc</i> | | 93040 | 93041 | 93042 |

INSIDE CORNER

| pack 5 pcs | | H | | | |
|------------------|--|---|-------|-------|-------|
| ART. finishing | | 8 | 10 | 12,5 | |
| ALUMINIUM | | | | | |
| FMAI/ | silver anodised <i>euro/pc</i> | | 93034 | 93035 | 93036 |
| FMBI/ | bright polished silver <i>euro/pc</i> | | 93043 | 93044 | 93045 |

END CAP

| pack 5 pcs | | H | | | |
|------------------|--|---|-------|-------|-------|
| ART. finishing | | 8 | 10 | 12,5 | |
| ALUMINIUM | | | | | |
| FMAC/ | silver anodised <i>euro/pc</i> | | 93037 | 93038 | 93039 |
| FMBC/ | bright polished silver <i>euro/pc</i> | | 93046 | 93047 | 93048 |

OUTSIDE CORNER

| pack 5 pcs | | H | | |
|------------------------|--|---|-------|-------|
| ART. finishing | | 8 | 10 | |
| STAINLESS STEEL | | | | |
| FMIE/ | stainless steel AISI 304 - DIN 1.4301 <i>euro/pc</i> | | 93058 | 93059 |
| FMIES/ | brushed stainless steel AISI 304 - DIN 1.4301 <i>euro/pc</i> | | 93064 | 93065 |

INSIDE CORNER

| pack 5 pcs | | H | | |
|------------------------|--|---|-------|-------|
| ART. finishing | | 8 | 10 | |
| STAINLESS STEEL | | | | |
| FMII/ | stainless steel AISI 304 - DIN 1.4301 <i>euro/pc</i> | | 93060 | 93061 |
| FMIS/ | brushed stainless steel AISI 304 - DIN 1.4301 <i>euro/pc</i> | | 93066 | 93067 |

END CAP

| pack 5 pcs | | H | | |
|------------------------|--|---|-------|-------|
| ART. finishing | | 8 | 10 | |
| STAINLESS STEEL | | | | |
| FMIC/ | stainless steel AISI 304 - DIN 1.4301 <i>euro/pc</i> | | 93062 | 93063 |
| FMICS/ | brushed stainless steel AISI 304 - DIN 1.4301 <i>euro/pc</i> | | 93068 | 93069 |

no partial packaging for aluminium accessories

Complete the article code with H measure (for example FMA/ for H=8 becomes FMA/8)

cerfix® proangle AX - pronivel M

Proangle AX M Design is a profile in anodised or colour-coated aluminium, which finishes the vertical edge of the coverings, accentuating the discontinuity between the wall in an elegant way.



AX/2/ silver anodised aluminium

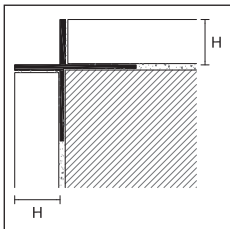

AX/2/



PROANGLE AX- M DESIGN

length = 270 cm - pack 10 pcs

| | | H | | |
|------------------|---------------------------------------|---|-------|-------|
| ART. | finishing | 6 | 10 | 12,5 |
| ALUMINIUM | | | | |
| | silver anodised | | 13208 | 13209 |
| | <i>euro/m</i> | | | |
| AX/2/ | titanium anodised | | 13211 | 13213 |
| | colour-coated polished white RAL 9010 | | 13215 | 13216 |
| | <i>euro/m</i> | | | |

individually packed

Pronivel M is a line of profiles designed to connect floors of different heights during the installation. Thanks to its shape, MIN/ can be also used as edging profile for the protection of 135-degree external corners of tile coverings.



MIN/10 polished stainless steel AISI 304 DIN 1.4301

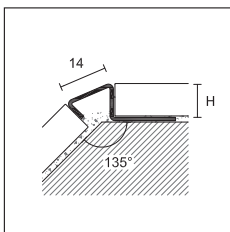

MIN/10



PRONIVEL M

length = 270 cm - pack 10 pcs

| | | H | |
|------|--|---|-------|
| ART. | finishing | 8 | 10 |
| MIN/ | polished stainless steel AISI 304 - DIN 1.4301 | | 93023 |
| | <i>euro/m</i> | | 93024 |

individually packed

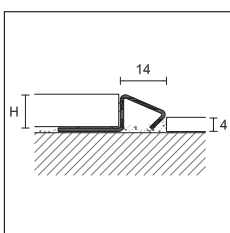

MIN/10 application for floors of different height

Complete the article code with H measure (for example MIN/ for H=10 becomes MIN/10)

cerfix® procorner M

Procorner M is a line of protection profiles of the outside corners of wall to be applied on the surfaces of the tiles already laid. Procorner profiles are also available in self-adhesive version for a quick and easy installation.

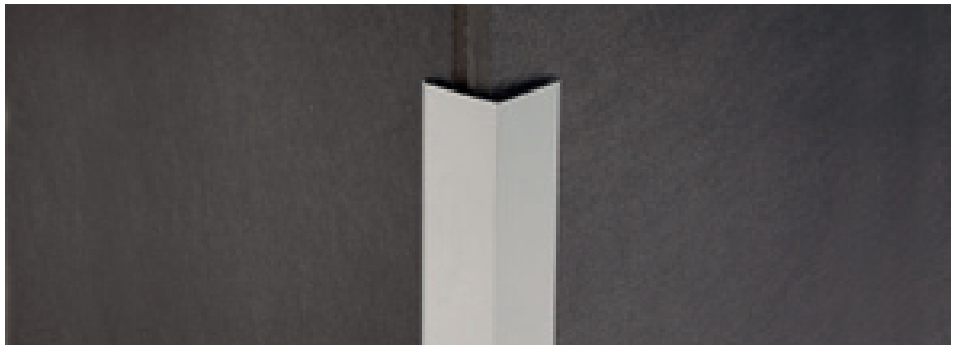

210/A silver anodised aluminium

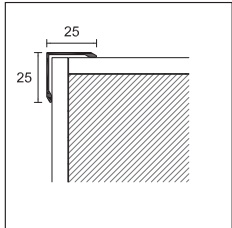

210/
210H/A



PROCORNER M

length = 300 cm - pack 30 pcs

LxL

25x25

| ART. | finishing | /SF | /A |
|------------------|------------------------------|-------|-------|
| ALUMINIUM | | | |
| | silver anodised | 76068 | 76098 |
| | gold anodised | - | 76108 |
| 210/ | euro/m | | |
| | colour-coated white RAL 9003 | 76128 | 76208 |

SF = not drilled A = adhesive
individually packed

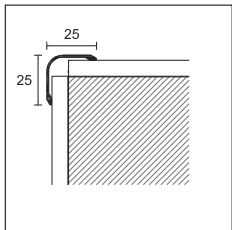

220/

PROCORNER M

length = 300 cm - pack 30 pcs

LxL

25x25

| ART. | finishing | /SF | /A |
|--|--|-------|----|
| ANTIBACTERIAL COLOUR-COATED ALUMINIUM | | | |
| 210H/A | colour-coated antibacterial white RAL 9003 | 76209 | |
| | euro/m | | |

A = adhesive
individually packed

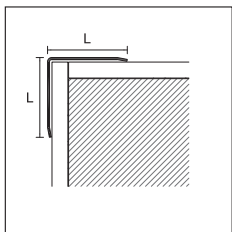

227/

PROCORNER M

length = 300 cm - pack 30 pcs

LxL

25x25

| ART. | finishing | /SF | /A |
|------------------|------------------------------|-------|-------|
| ALUMINIUM | | | |
| | silver anodised | 77888 | 77894 |
| 220/ | euro/m | | |
| | colour-coated white RAL 9003 | 77900 | - |
| | euro/m | | - |

SF = not drilled A = adhesive
individually packed

PROCORNER M

SILVER ANODISED ALUMINIUM

length = 300 cm - pack 30 pcs

| ART. | measure LxL | code | euro/m |
|----------------|-----------------------|-------|--------|
| 277/SF/ | 20x20 | 76308 | |
| 277/A/ | adhesive 20x20 | 76309 | |
| 277/SF/ | 25x25 | 76318 | |
| 277/A/ | adhesive 25x25 | 76319 | |
| 277/SF/ | 30x30 | 76328 | |
| 277/A/ | adhesive 30x30 | 76329 | |

individually packed

Complete the article code with L measure (for example 277/SF/ for L= 20 becomes 277/SF/20)

Upon request, we can manufacture cerfix® procorner' with different dimensions. Please contact our technical department for further information.



775/A/40 polished stainless steel AISI 304 DIN 1.4301

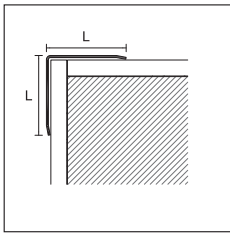

777/
776/

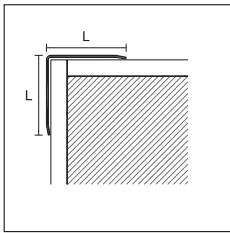

775/

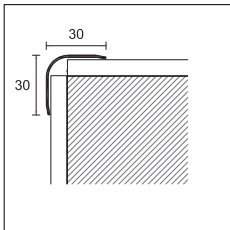

774/

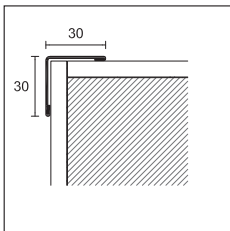

779/SF

PROCORNER M

POLISHED STAINLESS STEEL AISI 430 DIN 1.4016

length = 300 cm - thickness = 0,60 mm

| ART. | measure LxL | code | euro/m | pack |
|-----------------|-------------|-------|--------|------|
| 777/SF/ | 15x15 | 76888 | | 30 |
| 777/A/ adhesive | 15x15 | 76938 | | 30 |
| 777/SF/ | 20x20 | 76898 | | 30 |
| 777/A/ adhesive | 20x20 | 76948 | | 30 |
| 777/SF/ | 25x25 | 76908 | | 15 |
| 777/A/ adhesive | 25x25 | 76958 | | 15 |
| 777/SF/ | 30x30 | 76918 | | 20 |
| 777/A/ adhesive | 30x30 | 76968 | | 20 |

length = 200 cm - thickness = 1 mm

| ART. | measure LxL | code | euro/m | pack |
|-----------------|-------------|-------|--------|------|
| 776/SF/ | 30x30 | 77004 | | 20 |
| 776/A/ adhesive | 30x30 | 77044 | | 20 |
| 776/SF/ | 40x40 | 77014 | | 10 |
| 776/A/ adhesive | 40x40 | 77054 | | 10 |
| 776/SF/ | 50x50 | 77024 | | 10 |
| 776/A/ adhesive | 50x50 | 77064 | | 10 |

length = 270 cm - thickness = 1 mm

| ART. | measure LxL | code | euro/m | pack |
|-----------------|-------------|-------|--------|------|
| 776/SF/ | 30x30 | 77008 | | 10 |
| 776/A/ adhesive | 30x30 | 77048 | | 10 |
| 776/SF/ | 40x40 | 77018 | | 10 |
| 776/A/ adhesive | 40x40 | 77058 | | 10 |
| 776/SF/ | 50x50 | 77028 | | 5 |
| 776/A/ adhesive | 50x50 | 77068 | | 5 |

POLISHED STAINLESS STEEL AISI 304 DIN 1.4301

length = 270 cm - thickness = 1 mm

| ART. | measure LxL | code | euro/m | pack |
|-----------------|-------------|-------|--------|------|
| 775/SF/ | 30x30 | 77108 | | 10 |
| 775/A/ adhesive | 30x30 | 77148 | | 10 |
| 775/SF/ | 40x40 | 77118 | | 10 |
| 775/SF/ | 50x50 | 77128 | | 5 |
| 775/A/ adhesive | 50x50 | 77168 | | 5 |

BRUSHED STAINLESS STEEL AISI 304 DIN 1.4301

length = 270 cm - thickness = 1 mm

| ART. | measure LxL | code | euro/m | pack |
|---------|-------------|-------|--------|------|
| 775/SF/ | 30x30 | 77110 | | 10 |
| 775/SF/ | 50x50 | 77130 | | 5 |

POLISHED STAINLESS STEEL AISI 304 DIN 1.4301

length = 270 cm - thickness = 1 mm

| ART. | measure LxL | code | euro/m | pack |
|--------|-------------|-------|--------|------|
| 774/SF | 30x30 | 77954 | | 10 |

BRUSHED STAINLESS STEEL AISI 304 DIN 1.4301

length = 270 cm - thickness = 1 mm

| ART. | measure LxL | code | euro/m | pack |
|--------|-------------|-------|--------|------|
| 779/SF | 30x30 | 77106 | | 10 |

SF = not drilled A = adhesive

Complete the article code with L measure (for example 777/SF/ for L=15 becomes 777/SF/15)

Upon request, we can manufacture cerfix® procorner with different dimensions. Please contact our technical department for further information.

cerfix® procorner M - procorner P

Procorner M is a profile for the protection of the external corners of coverings. Recommended in places such as schools, offices, kindergartens and public spaces, it is available in polished brass to highlight the covering corners.

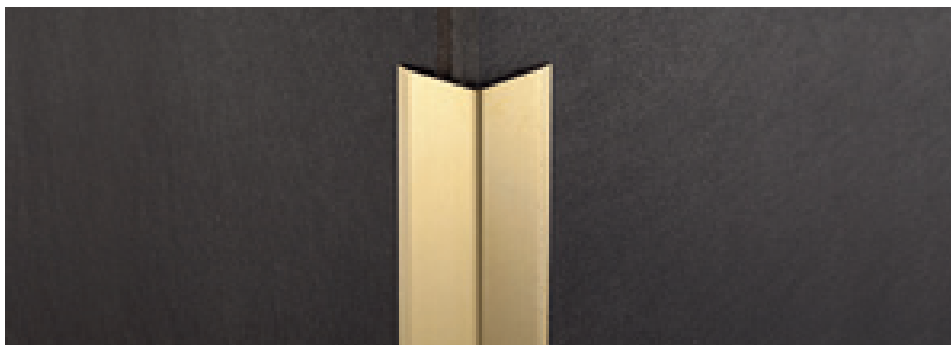

076/A/30 polished brass

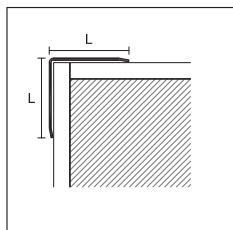

076/SF/
076/A/



PROCORNER M

POLISHED BRASS

length = 270 cm - thickness = 1,00 mm

| ART. | measure LxL | code | euro/m | pack |
|-----------------|-------------|-------|--------|------|
| 076/SF/ | 15x15 | 76800 | | 30 |
| 076/A/ adhesive | 15x15 | 76840 | | 15 |
| 076/SF/ | 20x20 | 76802 | | 15 |
| 076/A/ adhesive | 20x20 | 76842 | | 15 |
| 076/SF/ | 25x25 | 76806 | | 15 |
| 076/A/ adhesive | 25x25 | 76846 | | 10 |
| 076/SF/ | 30x30 | 76808 | | 10 |
| 076/A/ adhesive | 30x30 | 76848 | | 10 |

SF = not drilled A = adhesive

Procorner P is an edge profile to protect from many issues. Recommended in environments such as schools, offices, kindergartens, public spaces, it is made of PVC soft and in bright colors to visually highlight the edges of the wall.

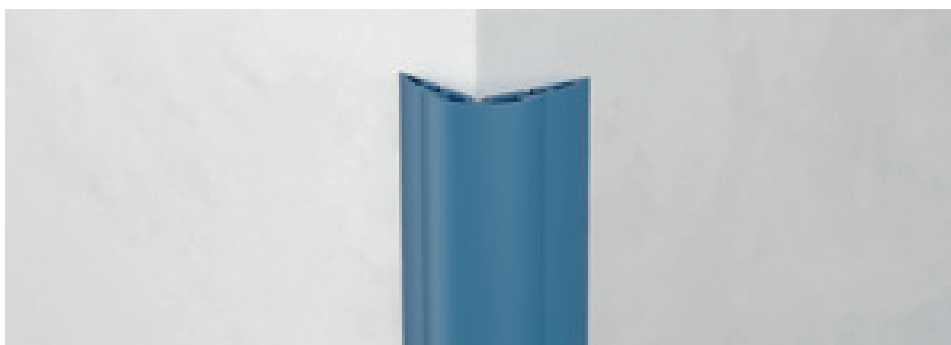

IP/40 blue soft PVC

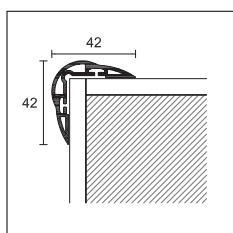

IP/40



PROCORNER P

length = 270 cm - pack 20 pcs

| ART. | finishing | LxL |
|-----------------|-----------|-------|
| SOFT PVC | | |
| IP/40 | white | 95010 |
| | yellow | 95011 |
| | red | 95012 |
| | blue | 95013 |
| euro/m | | |

Complete the article code with L measure (for example 076/SF/ for L=15 becomes 076/SF/15)

Upon request, we can manufacture cerfix® procorner with different dimensions. Please contact our technical department for further information.

Article IP/40 in PVC should be stored horizontally

Procorner P 8610 and 8611 are a line of edging profiles in foam PVC that are impact resistant. Quick and easy to install, they are particularly suitable for DIY installations. Available in different vivid colours, they are suitable for places like schools, kindergartens and public spaces in general.



8610 white dec. 555

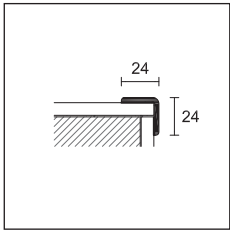

8610



PROCORNER P

length 300 cm - pack 20/50 pcs

FOAM PVC

| ART. | decors | | decors | | decors | |
|-------------|--------|-------|----------------|-------|----------------|-------|
| | 518 | 29810 | 536 | 29830 | yellow 561 | 29848 |
| | 520 | 29812 | 540 | 29832 | green 562 | 29850 |
| | 524 | 29814 | 542 | 29834 | light blue 563 | 29847 |
| | 525 | 29816 | 544 | 29836 | red 564 | 29849 |
| 8610 | 528 | 29818 | 545 | 29838 | | |
| | 530 | 29820 | white 555 | 29840 | | |
| | 531 | 29822 | light grey 556 | 29842 | | |
| | 532 | 29824 | black 557 | 29844 | | |
| | 534 | 29828 | anthracite 558 | 29846 | | |

pack 20 pcs

euro/m

pack 50 pcs

euro/m

no partial packaging

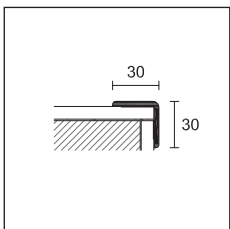

8611

PROCORNER P

length 300 cm - pack 20/50 pcs

FOAM PVC

| ART. | decors | | decors | | decors | | decors | |
|-------------|--------|-------|----------------|-------|----------------|-------|-----------------|-------|
| | 518 | 29910 | white 555 | 29940 | yellow 561 | 29946 | silver dec. 559 | 29949 |
| 8611 | 532 | 29924 | light grey 556 | 29942 | green 562 | 29948 | | |
| | 542 | 29934 | black 557 | 29944 | light blue 563 | 29945 | | |
| | 545 | 29938 | | | red 564 | 29947 | | |

pack 20 pcs

euro/m

pack 50 pcs

euro/m

no partial packaging



8610 dec. 532

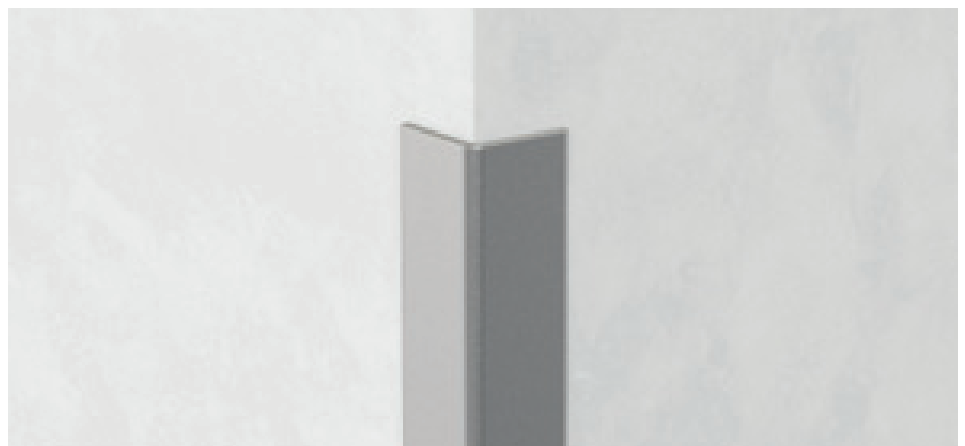

8611 silver dec. 559

Skirting board available with the same decors on page 217

external corners profiles

cerfix® probord

Stainless steel Probord ILN is a security profile for the outside corners of wall tiles. It can be combined with the profiles Proround M and it is recommended for the prevention of accidents and in environments where high hygienic safety is also required such as kitchens, food industries, schools etc.. The version in AISI 316 stainless steel is suitable for swimming pools, spa and in environments exposed to salt.



ILN/10 polished stainless steel AISI 304 DIN 1.4301

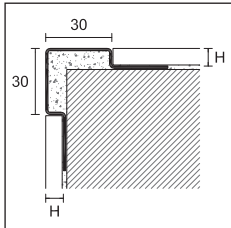

ILN/
ILNS/
ILNX/



PROBORD

length = 270 cm - pack 5 pcs

H

| ART. | finishing | 8 | 10 | 12,5 |
|------|-----------|---|----|------|
|------|-----------|---|----|------|

STAINLESS STEEL

| | | | | | |
|---------------|---|--|-------|-------|-------|
| ILN/ | polished stainless steel AISI 304 - DIN 1.4301 | | 94997 | 94998 | 94999 |
| euro/m | | | | | |
| ILNS/ | brushed stainless steel AISI 304 - DIN 1.4301 | | 94984 | 94985 | 94986 |
| euro/m | | | | | |
| ILNX/ | stainless steel AISI 316 - DIN 1.4404 | | 94987 | 94988 | 94989 |
| euro/m | | | | | |

individually packed

Probord IL, ILE and ILES have a rounded angle (compared to the model ILN). The fixing system with a single flange favors the correct alignment of the profile even in the presence of corners and uneven surfaces.



IL/10 polished stainless steel AISI 304 DIN 1.4301

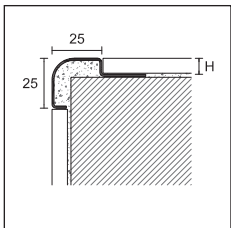

IL/



PROBORD

length = 270 cm - pack 10 pcs

H

| ART. | finishing | 8 | 10 | 12,5 |
|------|-----------|---|----|------|
|------|-----------|---|----|------|

STAINLESS STEEL

| | | | | | |
|---------------|--|--|-------|-------|-------|
| IL/ | stainless steel AISI 304 - DIN 1.4301 | | 94994 | 94995 | 94996 |
| euro/m | | | | | |

individually packed

PROBORD

length = 270 cm - pack 5 pcs

H

| ART. | finishing | 10 |
|------|-----------|----|
|------|-----------|----|

STAINLESS STEEL

| | | | |
|---------------|---|--|-------|
| ILE/10 | polished stainless steel AISI 304 - DIN 1.4301 | | 95002 |
| euro/m | | | |
| ILES/10 | brushed stainless steel AISI 304 - DIN 1.4301 | | 95003 |
| euro/m | | | |

individually packed

Upon request, we can manufacture ILE/ and ILES/ with different dimensions or in stainless steel AISI 316 - DIN 1.4404.

Complete the article code with H measure (for example ILN/ for H=8 becomes ILN/8)

Upon request, we can manufacture cerfix profiles, probord ILN/ and IL/ with different dimensions.

Please contact our technical department for further information.

Cerfix Protop® is a profile for the protection and finishing of external corners of worktops and ceramic-coated kitchens. Also recommended for running boards and steps made with tiles.



TOP/A/10 silver anodised aluminium

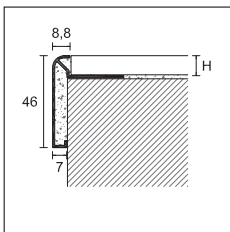

TOP/A/
TOP/TM/



PROTOP

length = 270 cm - pack 10 pcs

| | | H | |
|------------------|-------------------------|-------|-------|
| ART. | finishing | 10 | 12 |
| ALUMINIUM | | | |
| TOP/A/ | silver anodised | 86050 | 86060 |
| | <i>euro/m</i> | | |
| TOP/TM/ | titanium anodised | 86052 | 86062 |
| | <i>euro/m</i> | | |
| TOP/TM/ | bright brushed titanium | 86051 | 86061 |
| | <i>euro/m</i> | | |

individually packed

OUTSIDE CORNER - pack 2 pcs

| | | 90° | | 135° | |
|------------------|-------------------------|----------------|-------|-------|-------|
| ART. | finishing | 90° | 135° | 90° | 135° |
| ALUMINIUM | | | | | |
| TOP/E | silver anodised | 86074 | 86072 | 86074 | 86072 |
| | titanium anodised | 86080 | 86082 | 86080 | 86082 |
| | | <i>euro/pc</i> | | | |
| TOP/ETM | bright brushed titanium | 86075 | 86073 | 86075 | 86073 |
| | <i>euro/pc</i> | | | | |

INSIDE CORNER - pack 2 pcs

| | | 90° | | 135° | |
|------------------|-------------------------|----------------|-------|-------|-------|
| ART. | finishing | 90° | 135° | 90° | 135° |
| ALUMINIUM | | | | | |
| TOP/I | silver anodised | 86078 | 86076 | 86078 | 86076 |
| | titanium anodised | 86081 | 86083 | 86081 | 86083 |
| | | <i>euro/pc</i> | | | |
| TOP/ITM | bright brushed titanium | 86079 | 86077 | 86079 | 86077 |
| | <i>euro/pc</i> | | | | |

no partial packaging



TOP/A/10 + TOP/90/E + TOP/135/I silver anodised aluminium

Complete the article code with H measure (for example TOP/A/ for H=10 becomes TOP/A/10)





listellos and decorative profiles

The line of decorative listellos provides a wide variety of finishes, suitable for endless combinations and multiple aesthetic architectural tastes, from classic to contemporary; they are applicable to all environments with ceramic tiles from kitchen to bathroom, from living rooms to large commercial spaces.

Prolist is a range of decorative listellos designed to create stylish and eye-catching aesthetic effects of wall tiles. They are available in different materials and colors, and can be coordinated to the profiles of the ranges PROTRIM and Proangle to obtain elegant and sophisticated combinations.

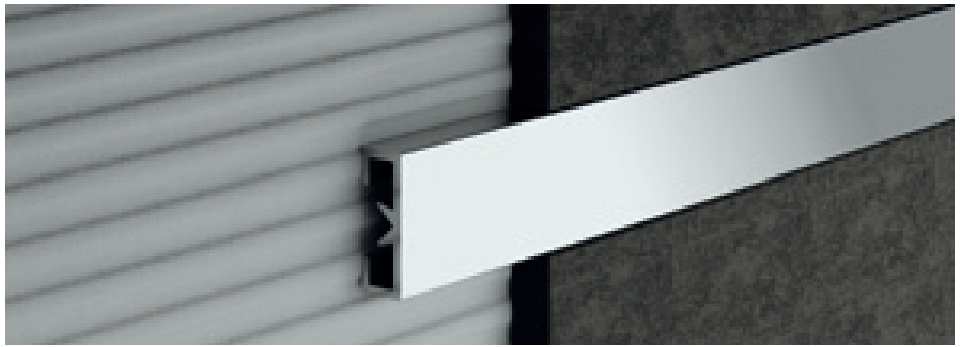

LDB/20 bright polished silver aluminium

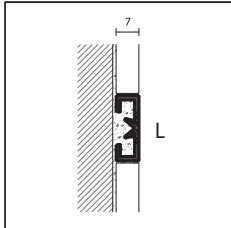

PROLIST

length = 270 cm - pack 20 pcs

| | | L x H | | | | |
|--------------------------------|--------------------------|-------|-------|-------|-------|-------|
| ART. | finishing | 10x7 | 15x7 | 20x7 | 25x7 | |
| ALUMINIUM | | | | | | |
| LDA/ | silver anodised | | 93255 | 93215 | 93220 | 93256 |
| | <i>euro/m</i> | | | | | |
| LDB/ | bright polished silver | | 93258 | 93219 | 93224 | 93259 |
| | bright polished titanium | | 93198 | 93199 | 93201 | 93203 |
| | <i>euro/m</i> | | | | | |
| LDS/ | bright brushed silver | | 93240 | 93216 | 93221 | 93244 |
| | bright brushed gold | | 93241 | 93217 | 93222 | 93245 |
| LDTM/ | bright brushed titanium | | 93266 | 93211 | 93225 | 93246 |
| LDRS/ | bright brushed copper | | 93242 | 93267 | 93229 | 93269 |
| | <i>euro/m</i> | | | | | |
| LDAG/ | bright scratched silver | | 93263 | 93214 | 93228 | 93243 |
| | <i>euro/m</i> | | | | | |
| COLOUR-COATED ALUMINIUM | | | | | | |
| LDV/ | white stone | | - | - | 93207 | - |
| | black stone | | - | - | 93209 | - |
| | <i>euro/m</i> | | | | | |

individually packed

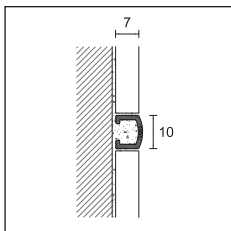

LB/B/10

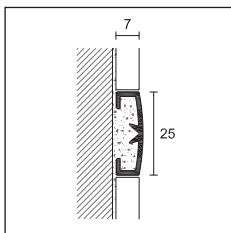

LB/A
LB/B/25

PROLIST

length = 270 cm - pack 20 pcs

| | | L x H | | |
|------------------|------------------------|-------|-------|-------|
| ART. | finishing | 10x7 | 25x7 | |
| ALUMINIUM | | | | |
| LB/A | silver anodised | | - | 93270 |
| | <i>euro/m</i> | | - | |
| LB/B/ | bright polished silver | | 93252 | 93272 |
| | bright polished gold | | 93253 | 93273 |
| | <i>euro/m</i> | | | |

individually packed

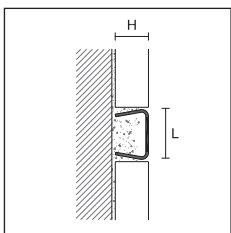

LA/I/
LA/IS/

PROLIST

length = 270 cm - pack 10 pcs

| | | L x H | | | |
|------------------------|---|-------|-------|-------|-------|
| ART. | finishing | 10x10 | 15x10 | 25x10 | |
| STAINLESS STEEL | | | | | |
| LA/I/ | polished stainless steel AISI 304 DIN 1.4301 | | 93283 | 93284 | 93285 |
| | <i>euro/m</i> | | | | |
| LA/IS/ | brushed stainless steel AISI 304 DIN 1.4301 | | 93296 | 93297 | 93298 |
| | <i>euro/m</i> | | | | |

individually packed

Complete the article code with L measure (for example LDA/ for L=10 becomes LDA/10)
Stainless steel listellos:
different measures on demand - minimum 108 meters

listellos and decorative profiles metal line AF - prolist x design

Metal Line AF M Design is a decorative listello in aluminium characterized by modern and minimalist lines that, thanks to its special shape, creates an elegant shadow that crosses the ceramic covering.



AF/1/10 silver anodised aluminium

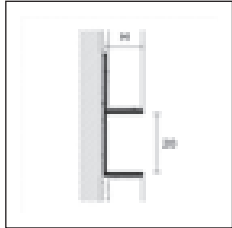

AF/1/



METAL LINE AF - M DESIGN

length = 270 cm - pack 10 pcs

| ART. | finishing | 6 | 10 | 12,5 |
|------------------|---------------------------------------|---|-------|-------|
| ALUMINIUM | | | | |
| | silver anodised | | 13198 | 13199 |
| | <i>euro/m</i> | | | |
| AF/1/ | titanium anodised | | 13201 | 13203 |
| | colour-coated polished white RAL 9010 | | 13196 | 13197 |
| | <i>euro/m</i> | | | |

individually packed

Prolist is available in five original finishes X Design. In anodised aluminium, X Design is characterized by a special scratched finish and original colours that allow different chromatic combinations, created for interior designers and architects by following the latest trends of modern design.



LDAD carbon anodised aluminium

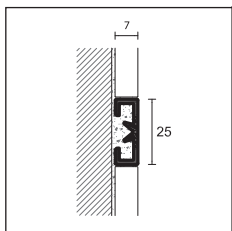

LDAD



PROLIST - X DESIGN

length = 270 cm - pack 10 pcs

| ART. | finishing | L x H |
|---------------------------|---------------|-------------|
| | | 25x7 |
| ANODISED ALUMINIUM | | |
| | platinum | |
| | titanium | |
| LDAD | brown | |
| | dark brown | |
| | carbon | |
| | <i>euro/m</i> | |

individually packed



LED-light decorative listellos on page 228



cerfix® C design

C Design is a line of profiles, embellished with crystals from Swarovski®. The combination of the chromium plated or gold plated profile and the crystal enhances the brightness of the lines and makes elegant any space.

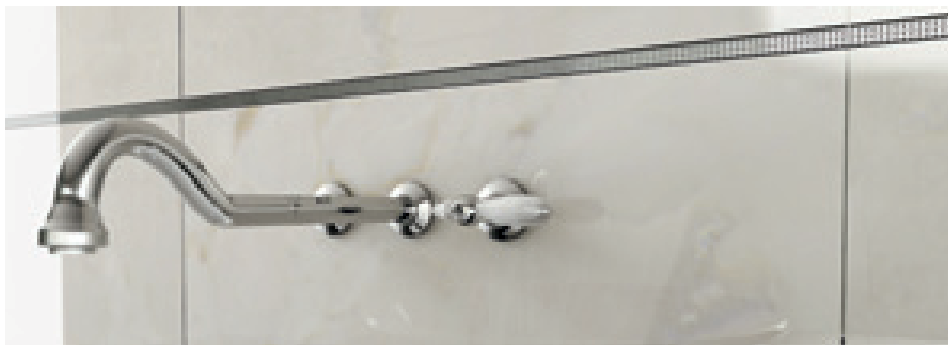

UKC/10 chromium-plated brass with crystals from Swarovski®

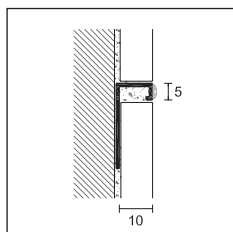

DJKC/10



PRODECOR - C DESIGN

length = 270 cm - pack 5 pcs

H

ART. finishing

10

CHROMIUM-PLATED BRASS

| | | | |
|---------|--|--|-------|
| | chromium-plated + crystals from Swarovski® | | 13300 |
| | <i>euro/m</i> | | |
| DJKC/10 | chromium-plated + crystals from Swarovski® | | 13302 |
| | <i>euro/m</i> | | |

individually packed

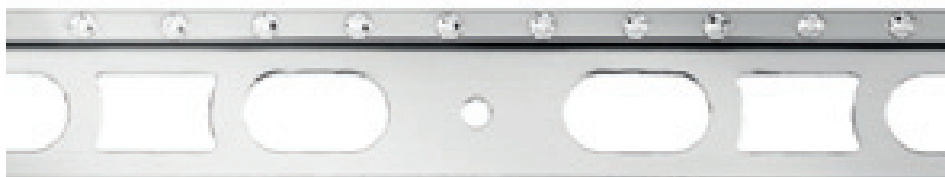

DJKC/10 chromium-plated brass with crystals from Swarovski® (cod. 13300)



DJKC/10 chromium-plated brass with crystals from Swarovski® (cod. 13302)

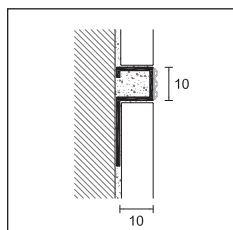

UKC/10

PROSTYLE - C DESIGN

length = 270 cm - pack 5 pcs

H

ART. finishing

10

CHROMIUM-PLATED BRASS

| | | | |
|--------|--|--|-------|
| UKC/10 | chromium-plated + crystals from Swarovski® | | 13310 |
| | <i>euro/m</i> | | |

individually packed

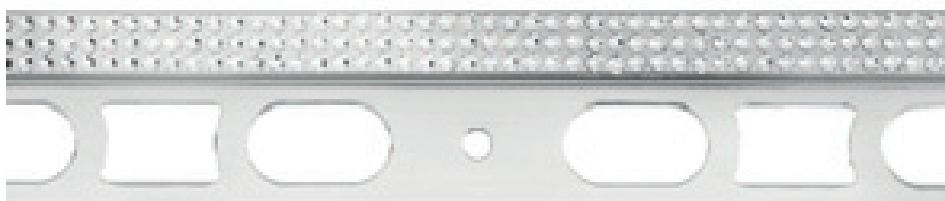

UKC/10 chromium-plated brass with crystals from Swarovski®

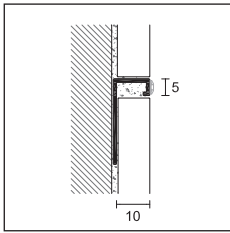

DJKGC/10



PRODECOR - C DESIGN

| | | |
|------------------------------|--|-----------|
| length = 270 cm - pack 5 pcs | | H |
| ART. | finishing | 10 |
| BRASS | | |
| DJKGC/10 | 24 kt gold plated + crystals from Swarovski® | 13402 |
| | euro/m | |

individually packed



DJKGC/10 24 kt gold plated brass + crystals from Swarovski®

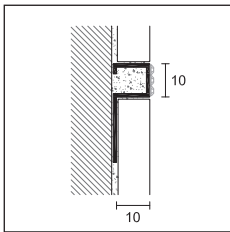

UKGC/10

PROSTYLE - C DESIGN

| | | |
|------------------------------|--|-----------|
| length = 270 cm - pack 5 pcs | | H |
| ART. | finishing | 10 |
| BRASS | | |
| UKGC/10 | 24 kt gold plated + crystals from Swarovski® | 13410 |
| | euro/m | |

individually packed

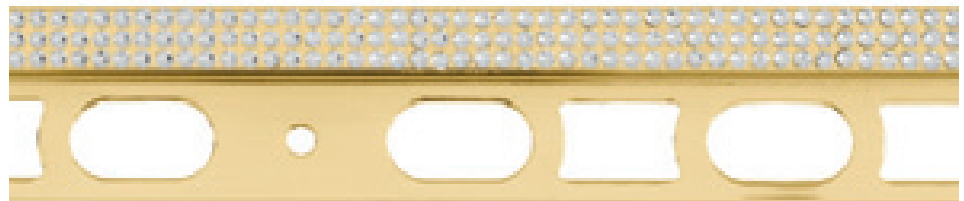

UKGC/10 24 kt gold plated brass + crystals from Swarovski®

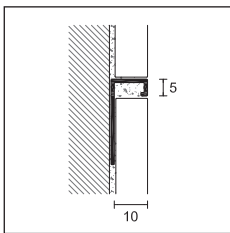

DJKG/10

PRODECOR - C DESIGN

| | | |
|------------------------------|------------------|-----------|
| length = 270 cm - pack 5 pcs | | H |
| ART. | finishing | 10 |
| BRASS | | |
| DJKG/10 | 24kt gold plated | 12902 |
| | euro/m | |

individually packed

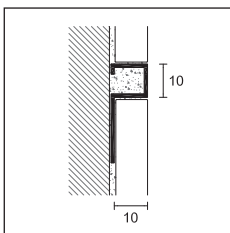

UKG/10

PROSTYLE - C DESIGN

| | | |
|------------------------------|------------------|-----------|
| length = 270 cm - pack 5 pcs | | H |
| ART. | finishing | 10 |
| BRASS | | |
| UKG/10 | 24kt gold plated | 12910 |
| | euro/m | |

individually packed





internal corners profiles

A line of profiles that fits the perimetric junction between floor and wall. Created for the elimination of 90° corners and applicable to installed or to be installed floors, ensure high hygienic efficiency in private and public environments such as hospitals, food industries, SPA, swimming pools and industrial kitchens.

internal corners profiles

cerfix® proround

Proround M in aluminum is a connection profile between floor and wall. The current requirements for sanitary maintenance required by European standards, provide in fact the elimination of the 90° to avoid any deposit of dirty and possible sources of bacteria, creating a curvature to facilitate cleaning.



GA/10 silver anodised aluminium

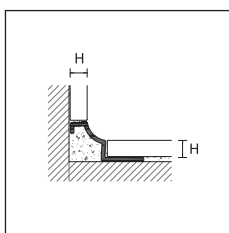

GA/4

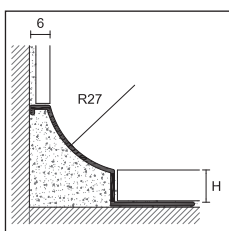

GA/8-10-12
GV/

PROROUND M

length = 270 cm - pack 10 pcs

| | | H | | | |
|------------------|---------------------------------|-------|-------|-------|-------|
| ART. | finishing | 4,5 | 8 | 10 | 12 |
| ALUMINIUM | | | | | |
| GA/ | silver anodised | 95730 | 95031 | 95032 | 95033 |
| | <i>euro/m</i> | | | | |
| GV/ | colour-coated white RAL 9003 | - | 95071 | 95072 | 95073 |
| | <i>euro/m</i> | - | | | |

individually packed- GA/4 packaging 20 pcs

OUTSIDE CORNER

pack 5 pcs

| | | H | |
|------------------|---------------------------------|-----|-------------|
| ART. | finishing | 4,5 | 8 - 10 - 12 |
| ALUMINIUM | | | |
| GTA/E | silver anodised | - | 95075 |
| | <i>euro/pc</i> | - | |
| GTV/E | colour-coated white RAL 9003 | - | 95083 |
| | <i>euro/pc</i> | - | |

INSIDE CORNER

pack 5 pcs

| | | H | |
|------------------|---------------------------------|-----|-------------|
| ART. | finishing | 4,5 | 8 - 10 - 12 |
| ALUMINIUM | | | |
| GTA/I | silver anodised | - | 95077 |
| | <i>euro/pc</i> | | |
| GTV/I | colour-coated white RAL 9003 | - | 95085 |
| | <i>euro/pc</i> | - | |

no partial packaging

Complete the article code with H measure (for example GA/ for H=8 becomes GA/8)

Items GV available in different colours on demand - minimum quantity 540 meters per colour.



GTA/E silver anodised aluminium



GTA/I silver anodised aluminium

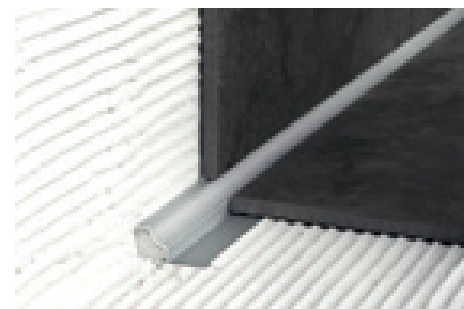

GA/4 silver anodised aluminium

Proround M GAN/ is a profile in aluminum for the connection between floor and wall, characterized by a 17-mm radius. GVNH/ boasts the certified antibacterial technology (in compliance with ISO 22196:2011 standards) which reduces the presence of the most dangerous bacteria up to 99%, thus assuring the best hygiene over time.



GAN/10 silver anodised aluminium

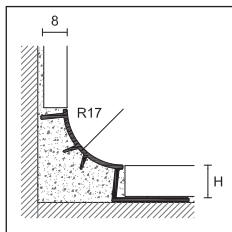

GAN/
GVNH/



PROROUND M

length = 270 cm - pack 10 pcs

| | | H | | |
|------------------|--|-------|-------|-------|
| ART. | finishing | 8 | 10 | 12,5 |
| ALUMINIUM | | | | |
| GAN/ | silver anodised | 95034 | 95035 | 95036 |
| <i>euro/m</i> | | | | |
| GVNH/ | colour-coated white RAL 9003 antibacterial | 95037 | 95038 | 95039 |
| <i>euro/m</i> | | | | |

individually packed

OUTSIDE/INSIDE/TRIAXIAL CORNER/END CAP

pack 12 pcs

| | | for all H | | | |
|----------------------|------------------------------|-----------|-------|-------|-------|
| ART. | finishing | GTP/E | GTP/I | GTP/T | GTP/C |
| POLYPROPYLENE | | | | | |
| | colour-coated silver | 95121 | 95122 | 95123 | 95124 |
| <i>euro/pc</i> | | | | | |
| | colour-coated white RAL 9003 | 95125 | 95126 | 95127 | 95128 |
| <i>euro/pc</i> | | | | | |

no partial packaging

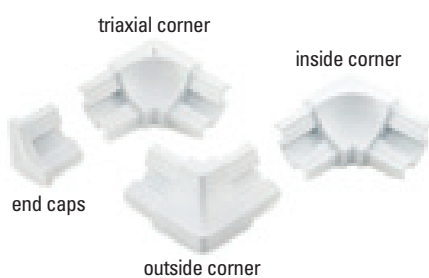

GTP/E silver colour-coated polypropylene

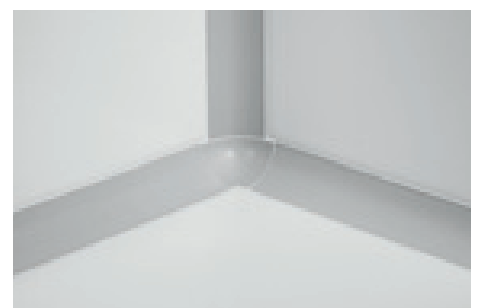

GTP/T silver colour-coated polypropylene

internal corners profiles

cerfix® proround

Stainless steel Proround M is a connection profile to be used in situations that require a particular level of sanitary protection (eg, medical, food industry, swimming pools, spas, industrial kitchens, hospitals, etc.). Specifically, the version in quality AISI 316 DIN 1.4404 offers characteristics of superior resistance to corrosion and is therefore recommended for use in areas subjected to higher chemical attacks, and sea zones.



GIN/10 + ILN/10 polished stainless steel AISI 304 DIN 1.4301

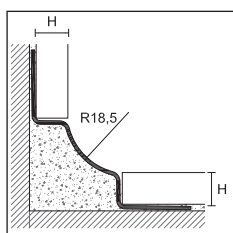

GIN 8/10/11

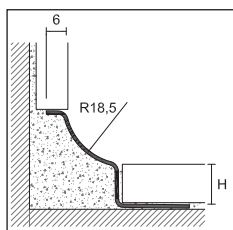

GIN /SA

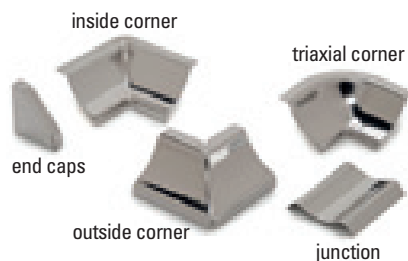

PROROUND M

length = 270 cm - pack 10 pcs

| ART. finishing | | 8 | 10 | 11 | 12,5 | 15 |
|------------------------|--|-------|-------|-------|------|----|
| STAINLESS STEEL | | | | | | |
| GIN/ | polished stainless steel AISI 304 DIN 1.4301 <i>euro/m</i> | 95046 | 95047 | 95045 | - | - |
| GINS/ | brushed stainless steel AISI 304 DIN 1.4301 <i>euro/m</i> | 95050 | 95051 | 95057 | - | - |
| GINX/ | stainless steel AISI 316 DIN 1.4404 <i>euro/m</i> | 95054 | 95055 | - | - | - |

individually packed

PROROUND M

length = 270 cm - pack 10 pcs

| ART. finishing | | 8 | 10 | 11 | 12,5 | 15 |
|------------------------|--|---|-------|----|-------|-------|
| STAINLESS STEEL | | | | | | |
| GIN/ /SA | polished stainless steel AISI 304 DIN 1.4301 <i>euro/m</i> | - | 95044 | - | 95048 | 95049 |
| GINS/ /SA | brushed stainless steel AISI 304 DIN 1.4301 <i>euro/m</i> | - | - | - | 95052 | - |
| GINX/ /SA | stainless steel AISI 316 DIN 1.4404 <i>euro/m</i> | - | - | - | 95056 | - |

individually packed

| | | OUTSIDE CORNER-E | | INSIDE CORNER-I | | | |
|------------------------|---|-------------------|--|-----------------|-------|-----------|-------|
| pack 5 pcs | | for all H | | for all H | | | |
| ART. finishing | | ART. | | ART. | | | |
| STAINLESS STEEL | | | | | | | |
| GTIN/E | polished stainless steel AISI 304 DIN 1.4301 <i>euro/pc</i> | 95059 | | GTIN/I | 95058 | | |
| GTINS/E | brushed stainless steel AISI 304 DIN 1.4301 <i>euro/pc</i> | 95063 | | GTINS/I | 95062 | | |
| GTINX/E | stainless steel AISI 316 DIN 1.4404 <i>euro/pc</i> | 95067 | | GTINX/I | 95066 | | |
| | | TRIAXIAL CORNER-T | | JUNCTION-G | | END CAPS | |
| pack 5 pcs | | for all H | | pack 5 pcs | | for all H | |
| ART. finishing | | ART. | | ART. | | ART. | |
| GTIN/T | polished stainless steel AISI 304 DIN 1.4301 <i>euro/pc</i> | 95060 | | GTIN/G | 95061 | GTIN/C | 95040 |
| GTINS/T | brushed stainless steel AISI 304 DIN 1.4301 <i>euro/pc</i> | 95064 | | GTINS/G | 95065 | GTINS/C | 95041 |
| GTINX/T | stainless steel AISI 316 DIN 1.4404 <i>euro/pc</i> | 95068 | | GTINX/G | 95069 | GTINX/C | 95042 |

no partial packaging

Complete the article code with H measure (for example GIN/ for H=8 becomes GIN/8)

Cerfix® Proround M in stainless steel: other measures on demand - minimum quantity 540 meters

Proround P in non-toxic PVC and impact resistant is a connection profile between floor and wall. The current requirements for sanitary maintenance required by European standards, provide in fact the elimination of the 90 ° to avoid any deposit of dirty and possible sources of bacteria, creating a curvature to facilitate cleaning. Models with a single anchor flange allow to be used as a connection between the laying floors and walls with different thickness.

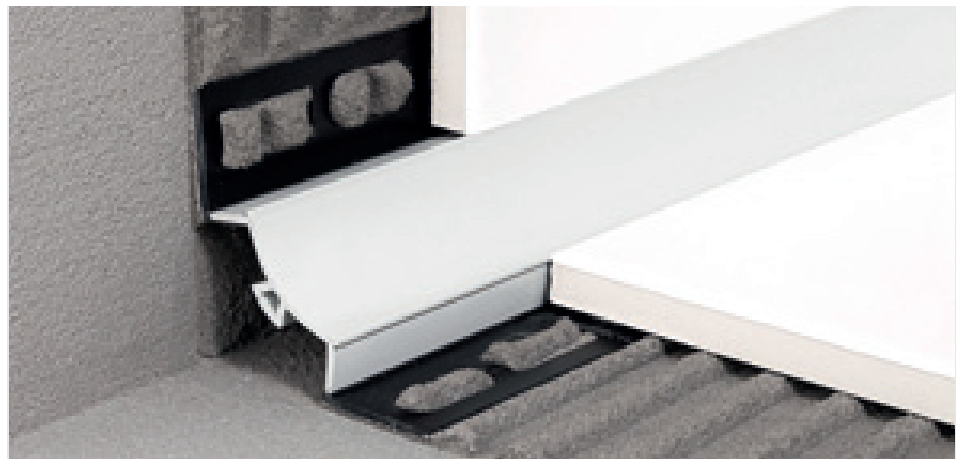

GP/10 white co-extruded PVC

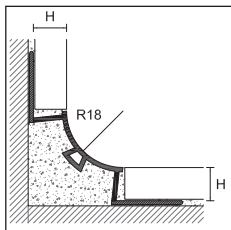

GP/

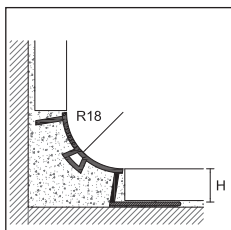

GPU/

PROROUND P

length = 270 cm - pack 20 pcs

| ART. | H | | H | |
|------------------------|----------|-----------|-----------|-------------|
| | GP/ | | GPU/ | |
| finishing | 8 | 10 | 10 | 12,5 |
| CO-EXTRUDED PVC | | | | |
| white | | 95800 | 95801 | 95804 |
| light grey RAL 7035 | | 95805 | 95806 | - |
| stone grey RAL 7030 | | 95810 | 95811 | - |
| beige grey RAL 1019 | | 95815 | 95816 | - |
| euro/m | | | | |

INSIDE/OUTSIDE/TRIAXIAL CORNER/END CAP

| ART. | for all H | | | |
|----------------------|-----------|-------|-------|-------|
| | GTP/E | GTP/I | GTP/T | GTP/C |
| POLYPROPYLENE | | | | |
| white | | 95852 | 95851 | 95850 |
| light grey RAL 7035 | | 95862 | 95861 | 95860 |
| stone grey RAL 7030 | | 95872 | 95871 | 95870 |
| beige grey RAL 1019 | | 95882 | 95881 | 95880 |
| euro/pc | | | | |

no partial packaging

Complete the article code with H measure (for example GP/ for H=8 becomes GP/8)



GTP/E RAL 7035 light grey polypropylene



GTP/T RAL 7035 light grey polypropylene

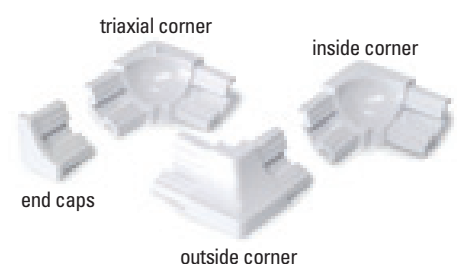

internal corners profiles

cerfix® proround

Proround M GIC/ and Proint PIN/ are two stainless steel profiles with rounded shape for the connection of floors and walls, to be used in those spaces where special hygiene protection is required.

The shape of GIC/ is particularly versatile thanks to the internal fixing flange.

The shape of PIN/ facilitates the corner connection of floors and walls, thus guaranteeing the expansion between the two surfaces.



GIC/8 polished stainless steel AISI 304 DIN 1.4301

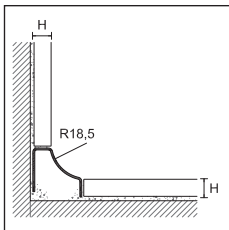

GIC/



PROROUND M

length = 270 cm - pack 5 pcs

ART. finishing

H

8

STAINLESS STEEL

GIC/ polished stainless steel
AISI 304 DIN 1.4301

95140

euro/m

OUTSIDE CORNER FOR GIC/

pack 5 pcs

ART. finishing

STAINLESS STEEL

GTIN/E polished stainless steel
AISI 304 DIN 1.4301

95059

euro/pc

no partial packaging

INSIDE CORNER FOR GIC/

pack 5 pcs

ART.

GTIN/I

95058

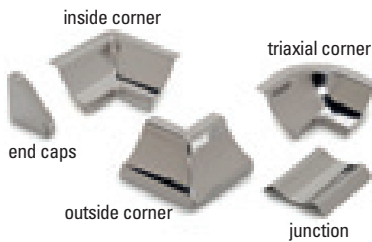

TRIAXIAL CORNER FOR GIC/

pack 5 pcs

ART. finishing

GTIN/T polished stainless steel
AISI 304 DIN 1.4301

95060

euro/pc

no partial packaging

JUNCTION FOR GIC/

pack 5 pcs

ART.

GTIN/G

95061

END CAPS FOR GIC/

ART.

GTIN/C

95040

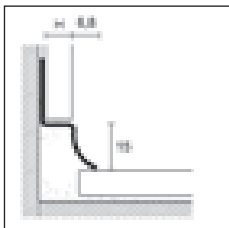

PIN/



PROINT

length = 270 cm - pack 10 pcs

ART. finishing

STAINLESS STEEL

PIN/ polished stainless steel
AISI 304 - DIN 1.4301

85392

euro/m

individually packed

H

10

12,5

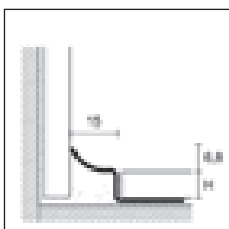

PIN/

Complete the article code with H measure (for example GIC/ for H=8 becomes GIC/8)

We can create profiles Cerfix Proround GIC/ with sizes on request, for floors and coverings of different thickness. Contact our technical department for more informations.



PIN/10 polished stainless steel AISI 304 DIN 1.4301

Proint PIA/ and PI/ are two line of profiles in aluminium and PVC, suitable as perimetral connection during the installation of the wall covering and the floor or as perimetral expansion joint.

The use of Proint PIA/ and PI/ allows to avoid the use of silicone for sealing and, in addition to the aesthetic advantage, it guarantees a high hygiene over time.

The special sections of Proint facilitate the corner connection between the wall covering and the floor, thus guaranteeing the expansion between the two surfaces.



PIA/9 silver anodised aluminium

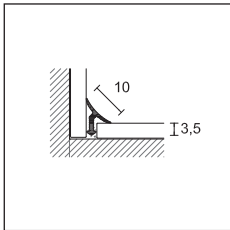

PIA/3

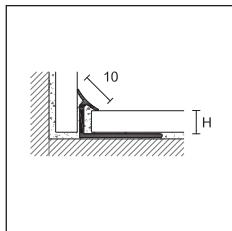

PI/
PI/

PROINT

length = 270 cm - pack 20 pcs

| | | H | | | |
|------------------|-----------------|-------|-------|-------|-------|
| ART. | finishing | 3,5 | 7 | 9 | 12 |
| ALUMINIUM | | | | | |
| PIA/ | silver anodised | 95431 | 95430 | 95432 | 95429 |
| <i>euro/m</i> | | | | | |

individually packed

PROINT

length = 270 cm - pack 20 pcs

| | | H | |
|------------------------|----------------------|-------|-------|
| ART. | finishing | 7 | 9 |
| CO-EXTRUDED PVC | | | |
| | snow white | 95396 | 95398 |
| | white | 95400 | 95402 |
| | cream white RAL 9001 | - | 95406 |
| | ivory RAL 1015 | - | 95418 |
| PI/ | beige grey RAL 1019 | - | 95410 |
| | stone grey RAL 7030 | - | 95422 |
| | ash grey RAL 7038 | - | 95433 |
| | light grey RAL 7035 | - | 95414 |

pack 20 pcs
euro/m

pack 100 pcs
euro/m

no partial packaging - to order the pack of 100 pcs, mark /100 after article code

Complete the article code with H measure (for example PIA/ for H=7 becomes PIA/7)

Items PI/ available in different colours on demand - minimum quantity 2700 meters per colour



PI/9 white co-extruded PVC



PIA/3 silver anodised aluminium

cerfix® proround

Proround B in aluminium or PVC are perimetral connection profiles to be used between floors and walls, specially designed for the application on already-laid surfaces. These profiles are the best solution for renovations and to be compliant with hygienic regulations. BLAH/ boasts the certified antibacterial technology (in compliance with ISO 22196:2011 standards) which reduces the presence of the most dangerous bacteria up to 99%, thus assuring the best hygiene over time.



BLA/20 silver anodised aluminium

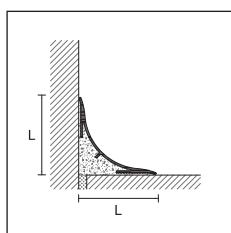

BLA/
BLAH/

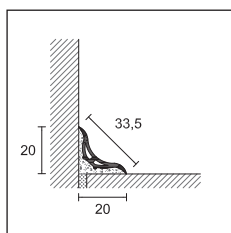

BL/20

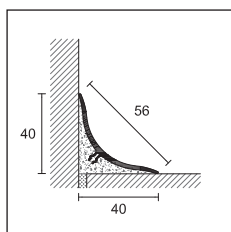

BL/40

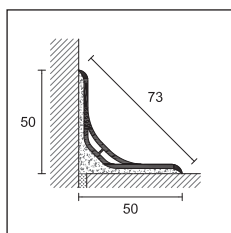

BL/50



polypropylene accessories

PROROUND B

length = 270 cm - pack 20 pcs

LxL

| ART. | finishing | 20x20 | 40x40 | 50x50 |
|--|---|-------|-------|-------|
| ALUMINIUM | | | | |
| BLA/ | silver anodised | 95570 | 95580 | - |
| | euro/m | | | - |
| ANTIBACTERIAL COLOUR-COATED ALUMINIUM | | | | |
| BLAH/ | colour-coated white RAL 9003 antibacterial | 95572 | 95582 | - |
| | euro/m | | | - |

individually packed

PROROUND B

length = 270 cm - pack 20 pcs

LxL

| ART. | finishing | 20x20 | 40x40 | 50x50 |
|------------|-----------|-------|-------|-------|
| PVC | | | | |
| BL/ | white | 95550 | 95500 | 95551 |
| | euro/m | | | |

POLYPROPYLENE ACCESSORIES PACK

8 pcs

4 pcs

4 pcs

OUTSIDE CORNER IN POLYPROPYLENE

| | | | | |
|---------|---------|-------|-------|-------|
| GBL/ /E | silver | 95574 | 95584 | - |
| | white | 95556 | 95510 | 95552 |
| | euro/pc | | | |

INSIDE CORNER IN POLYPROPYLENE

| | | | | |
|---------|---------|-------|-------|-------|
| GBL/ /I | silver | 95576 | 95586 | - |
| | white | 95557 | 95512 | 95553 |
| | euro/pc | | | |

TRIAXIAL CORNER IN POLYPROPYLENE

| | | | | |
|---------|---------|---|-------|-------|
| GBL/ /T | silver | - | 95588 | - |
| | white | - | 95511 | 95554 |
| | euro/pc | - | | |

RIGHT-LEFT END CAPS IN POLYPROPYLENE

| | | | | |
|---------|---------|-------|-------|-------|
| GBL/ /C | silver | 95578 | 95590 | - |
| | white | 95558 | 95513 | 95555 |
| | euro/pc | | | |

no partial packaging - article GBL/ /C pack of 16 pcs (20x20) and 8 pcs (40x40 and 50x50)

Complete the article code with L measure (for example BLA/ for L= 20 becomes BLA/20)

Proround B in stainless steel are perimetral connection profiles to be used between floors and walls, specially designed for the application on already-laid surfaces. These profiles are the best solution for renovations and to be compliant with hygienic regulations.

Stainless steel is particularly resistant to the attack of organic and inorganic agents and, therefore, it is suitable in spaces such as hospitals, food and chemical industries.



BI/40 stainless steel AISI 304 DIN 1.4301

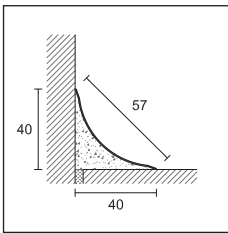

BI/40
BI/40/A



PROROUND B

length = 270 cm - pack 20 pcs

LxL

ART. finishing 40x40

STAINLESS STEEL

| | | | |
|-------------------------|---|--|-------|
| BI/40 | stainless steel AISI 304 DIN 1.4301 <i>euro/m</i> | | 94992 |
| BI/40/A adhesive | stainless steel AISI 304 DIN 1.4301 <i>euro/m</i> | | 94993 |

POLYPROPYLENE MATCHING CHROMIUM FINISH PACK 4 PCS

OUTSIDE CORNER IN POLYPROPYLENE

| | | | |
|--------------|--|--|-------|
| GTL/E | polypropylene chromium effect <i>euro/pc</i> | | 95515 |
|--------------|--|--|-------|

INSIDE CORNER IN POLYPROPYLENE

| | | | |
|--------------|--|--|-------|
| GTL/I | polypropylene chromium effect <i>euro/pc</i> | | 95517 |
|--------------|--|--|-------|

TRIAXIAL CORNER IN POLYPROPYLENE

| | | | |
|--------------|--|--|-------|
| GTL/T | polypropylene chromium effect <i>euro/pc</i> | | 95516 |
|--------------|--|--|-------|

RIGHT-LEFT END CAPS IN POLYPROPYLENE

| | | | |
|--------------|--|--|-------|
| GTL/C | polypropylene chromium effect <i>euro/pc</i> | | 95518 |
|--------------|--|--|-------|

no partial packaging





linear shower drains and systems for bathrooms

Profilpas offers a wide range of solutions for bathrooms which combine functionality and modern design. In particular, Profilpas bathroom systems allow the creation of floor-level showers, with a wide selection of linear shower drains - like PP Drain Aqua, Thin Drain, Slim Drain and Smart Drain, all customizable with different grates - and Q-Drain, available in several models. Profilpas bathroom range also includes Glass Profile, a line of profiles for the insertion of glass walls and the finishing of the shower surface, designed to compensate the 2% slope.



PP Drain Aqua

PPdrain | Aqua

The linear shower drains PP Drain Aqua, made of stainless steel AISI 316 and provided with a patented removable siphon in antibacterial ABS, are a perfect synthesis of beauty and practicality. Profilpas has taken care of every aspect of their design, production and quality control, to offer a product that is always efficient and aesthetically perfect.

The linear shower drains PP Drain Aqua, composed of a single piece without welds, distinguish for their design and functionality that make them elegant, simple to install and easy to clean. Each part of the shower drain is studied in detail, to contain in few components all that is needed to guarantee the maximum ease of installation and maintenance.

Aesthetics



Elegant and exclusive design, customisable with a wide range of covers and finishes.

Removable siphon

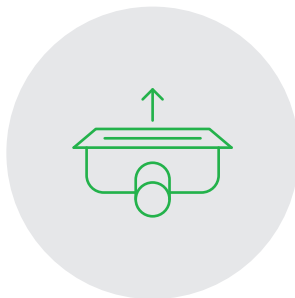

The siphon is simple to remove and can be easily inspected, for the maximum efficiency.

Ease of installation

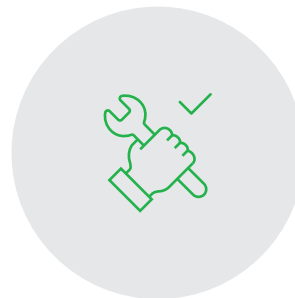

The assembly and the adjustment of the shower drain are simplified, for a simple and quick installation.

Cleanliness and hygiene



The removable siphon in antibacterial ABS simplifies the maintenance and allows a quick and efficient cleanliness.



PP Drain Aqua

The essentiality of the linear shape of the shower drain, combined to the beauty of the multiple finishes, allows to offer an aesthetically perfect solution, able to adapt to any kind of design and to any material (porcelain stoneware, marble, mosaic, natural stone...).

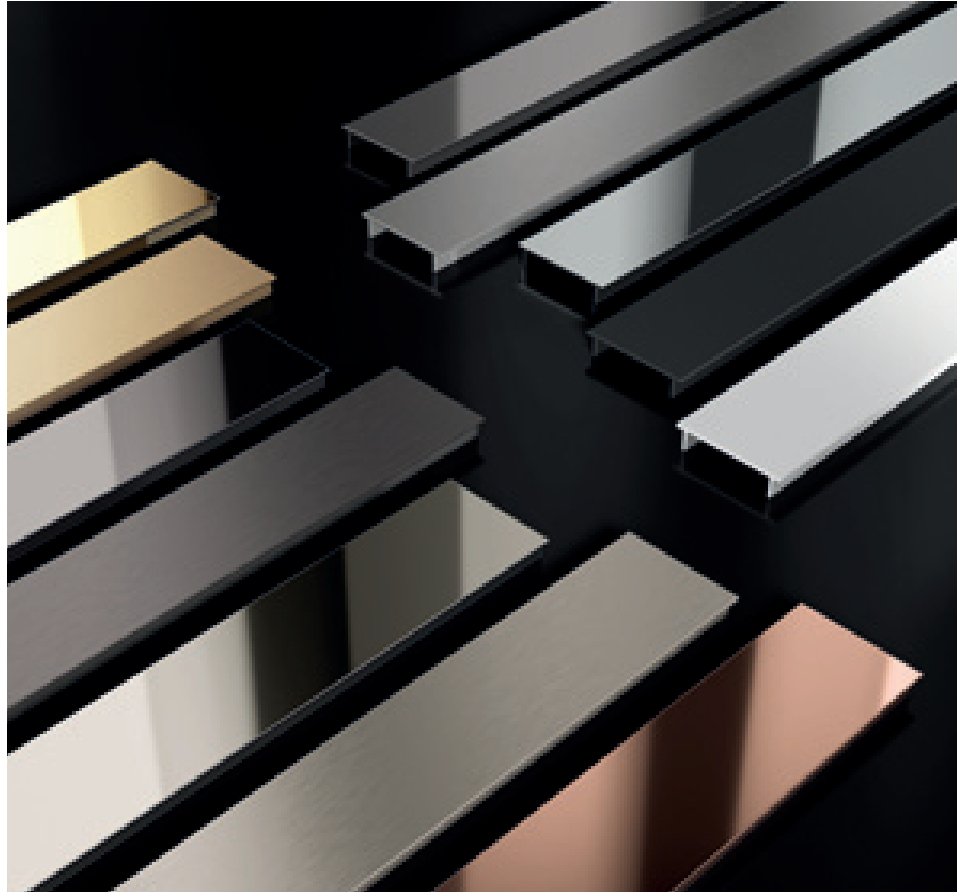

PP Drain Aqua

With PP Drain Aqua linear shower drains, maintenance and cleaning are fully simplified. The siphon, made of antibacterial ABS, can be removed and inspected completely. Furthermore, the AISI 316 stainless steel shower drain base is composed of a single piece without welds and sharp edges for the best hygiene and efficiency. Studied to minimize installation times, they are equipped with a pre-glued waterproofing membrane, supports from 6 to 18 mm for the height adjustment of the covers and bases in polystyrene foam.



PP Drain Aqua



PP DRAIN AQUA - shower drain base with siphon

| | | L | | | | | |
|------------------------|---|-------|-------|-------|-------|--------|-------------|
| ART. | finishing | 60 cm | 70 cm | 80 cm | 90 cm | 100 cm | 120 cm |
| STAINLESS STEEL | | | | | | | |
| PP/ | stainless steel AISI 316 DIN 1.4404 euro/pc | | 22100 | 22101 | 22102 | 22103 | 22104 22105 |

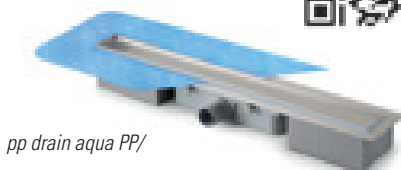

pp drain aqua PP/

PP DRAIN AQUA - shower drain base with direct drainage diam. 50 mm

| | | L | | | | | |
|------------------------|---|-------|-------|-------|-------|--------|-------------|
| ART. | finishing | 60 cm | 70 cm | 80 cm | 90 cm | 100 cm | 120 cm |
| STAINLESS STEEL | | | | | | | |
| PP50/ | stainless steel AISI 316 DIN 1.4404 euro/pz | | 22106 | 22107 | 22108 | 22109 | 22110 22111 |



pp drain aqua PP50/

Shower drain base with direct drainage diam. 40 mm available upon request.

NEW PP DRAIN AQUA 360 - shower drain base with 360° swivelling siphon

| | | L | | | | | |
|------------------------|---|-------|-------|-------|-------|--------|-------------|
| ART. | finishing | 60 cm | 70 cm | 80 cm | 90 cm | 100 cm | 120 cm |
| STAINLESS STEEL | | | | | | | |
| PP360/ | stainless steel AISI 316 DIN 1.4404 euro/pz | | 22180 | 22181 | 22182 | 22183 | 22184 22185 |



pp drain aqua PP360/

cover¹

frame²

ABS supports

hair catcher filter

removable top in antibacterial ABS

removable siphon in antibacterial ABS

waterproofing membrane

single-piece base in stainless steel AISI 316

base in polystyrene

drain in antibacterial ABS

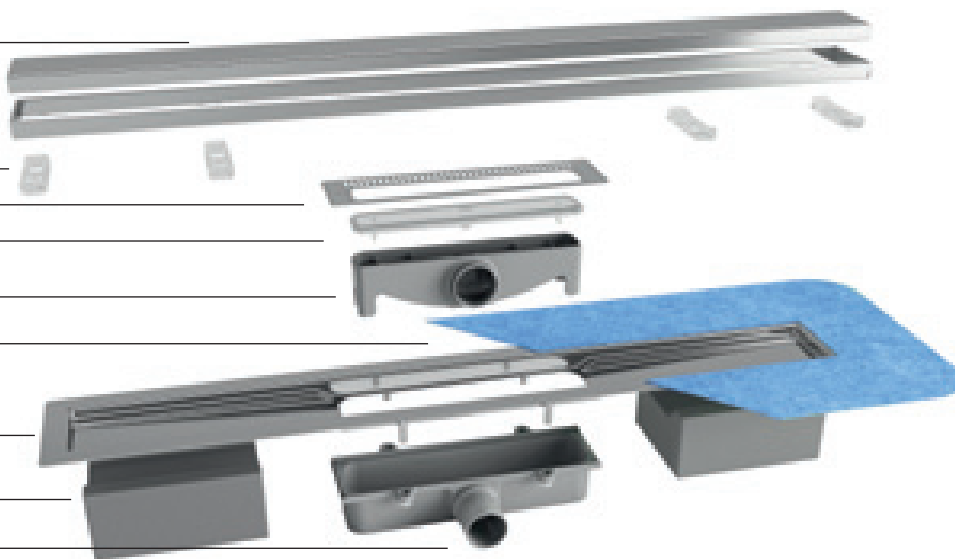

¹ Different types of cover available.

² The frame is present in Classic Cover model. The other covers are not equipped with frame.

Complete the article code with L measure (for example PP/ for L = 70 becomes PP/70)

Classic Cover, in polished or brushed stainless steel AISI 316, is available in different lengths (from 60 to 120 cm). It includes the frame and the adjustment supports from 6 to 18 mm, and it is reversible: if turned upside down, it becomes tileable (up to 12 mm), thus creating aesthetic continuity with the bathroom covering.



PP Drain Aqua - Classic Cover polished stainless steel AISI 316 - DIN 1.4404

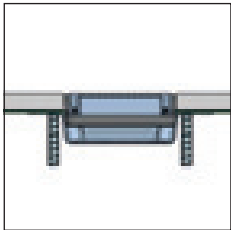

Classic Cover

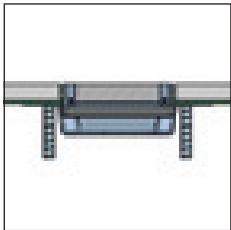



Classic Cover tileable



Classic Cover brushed stainless steel AISI 316 DIN 1.4404

CLASSIC COVER - tiles thickness from 6 to 18 mm

| | | L | | | | | | |
|------------------------|--|---|-------|-------|-------|--------|--------|-------|
| ART. | finishing | 60 cm | 70 cm | 80 cm | 90 cm | 100 cm | 120 cm | |
| STAINLESS STEEL | | | | | | | | |
| XPC/ | polished stainless steel AISI 316 DIN 1.4404 |  | 22112 | 22113 | 22114 | 22115 | 22116 | 22117 |
| | brushed stainless steel AISI 316 DIN 1.4404 |  | 22118 | 22119 | 22120 | 22121 | 22122 | 22123 |
| euro/pc | | | | | | | | |

Classic Cover is reversible, if turned upside down it becomes tileable (with a thickness up to 12 mm).



PP Drain Aqua - Design Cover brushed stainless steel AISI 316 DIN 1.4404

Complete the article code with L measure (for example XPC/ for L = 70 becomes XPC/70)

PP Drain Aqua

Flat Cover, available in several finishes and different lengths (from 60 to 120 cm), stands out for the perfectly flat and linear design. It is provided with adjustment supports that allow it to be adapted to tiles with thickness from 6 to 18 mm.



PP Drain Aqua - Flat Cover matt black colour-coated aluminium

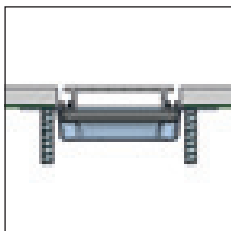

Flat Cover aluminium

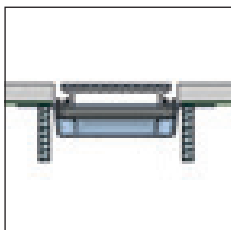

Flat Cover aluminium + stainless steel



Flat Cover chromium-plated stainless steel

FLAT COVER - tiles thickness from 6 to 18 mm

| ART. | finishing | | L | | | | | |
|--|--|--|-------|-------|-------|-------|--------|-------|
| | | | 60 cm | 70 cm | 80 cm | 90 cm | 100 cm | |
| ALUMINIUM + STAINLESS STEEL | | | | | | | | |
| XPF/ | polished stainless steel AISI 316 DIN 1.4404 | | 22136 | 22137 | 22138 | 22139 | 22140 | 22141 |
| | brushed stainless steel AISI 316 DIN 1.4404 | | 22142 | 22143 | 22144 | 22145 | 22146 | 22147 |
| <i>euro/pc</i> | | | | | | | | |
| ALUMINIUM + CHROMIUM-PLATED STAINLESS STEEL | | | | | | | | |
| XPF/ | chromium-plated stainless steel AISI 316 DIN 1.4404 | | 22261 | 22262 | 22263 | 22264 | 22265 | - |
| <i>euro/pc</i> | | | | | | | | |
| COLOUR-COATED ALUMINIUM | | | | | | | | |
| XPF/ | matt white | | 22148 | 22149 | 22150 | 22151 | 22152 | - |
| | matt black | | 22154 | 22155 | 22156 | 22157 | 22158 | - |
| <i>euro/pc</i> | | | | | | | | |
| ALUMINIUM + STAINLESS STEEL | | | | | | | | |
| XPF/ | polished nickel | | 22226 | 22227 | 22228 | 22229 | 22230 | - |
| | brushed nickel | | 22231 | 22232 | 22233 | 22234 | 22235 | - |
| | polished pink gold | | 22236 | 22237 | 22238 | 22239 | 22240 | - |
| | <i>euro/pc</i> | | | | | | | |
| | polished graphite | | 22241 | 22242 | 22243 | 22244 | 22245 | - |
| | brushed graphite | | 22246 | 22247 | 22248 | 22249 | 22250 | - |
| <i>euro/pc</i> | | | | | | | | |
| XPF/ | polished gold | | 22251 | 22252 | 22253 | 22254 | 22255 | - |
| | brushed gold | | 22256 | 22257 | 22258 | 22259 | 22260 | - |
| <i>euro/pc</i> | | | | | | | | |



Flat Cover

Complete the article code with L measure (for example XPF/ for L = 70 becomes XPF/70)

PP Drain Aqua

Design Cover stands out for the absolute elegance of its design and for the central drain. In polished or brushed stainless steel AISI 316, it is available in different lengths, from 60 to 120 cm.



PP Drain Aqua - Design Cover brushed stainless steel AISI 316 DIN 1.4404

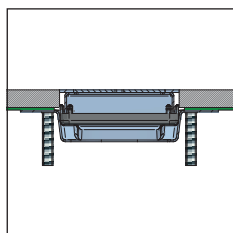



Design Cover



Design Cover

DESIGN COVER - tiles thickness from 6 to 18 mm

| ART. | finishing | L | | | | | | |
|------------------------|--|---|-------|-------|-------|--------|--------|-------|
| | | 60 cm | 70 cm | 80 cm | 90 cm | 100 cm | 120 cm | |
| STAINLESS STEEL | | | | | | | | |
| XPD/ | polished stainless steel AISI 316 DIN 1.4404 |  | 22214 | 22215 | 22216 | 22217 | 22218 | 22219 |
| | brushed stainless steel AISI 316 DIN 1.4404 |  | 22220 | 22221 | 22222 | 22223 | 22224 | 22225 |
| euro/pc | | | | | | | | |

With Invisible Cover, the shower tray and the linear shower drain become as one and blend perfectly with the bathroom covering. In natural aluminium and different lengths (from 60 to 120 cm), it disappears under the tile for a completely invisible aesthetic effect.



PP Drain Aqua - Invisible Cover

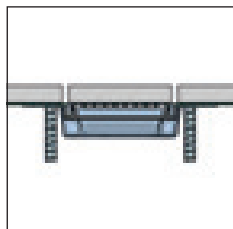

Invisible Cover



Invisible Cover

INVISIBLE COVER

| ART. | finishing | L | | | | | | |
|------------------|-------------------|---|-------|-------|-------|--------|--------|-------|
| | | 60 cm | 70 cm | 80 cm | 90 cm | 100 cm | 120 cm | |
| ALUMINIUM | | | | | | | | |
| XPI/ | natural aluminium |  | 22130 | 22131 | 22132 | 22133 | 22134 | 22135 |
| euro/pc | | | | | | | | |

Complete the article code with L measure (for example XPD/ for L = 70 becomes XPD/70)

thin drain

thindrain

Thin Drain is a line of flush with the floor shower drains for a quick and easy installation, which allows to customize the shower with any kind of covering. Thanks to the syphon with low thickness and the height of the shower drain of just 55 mm, they are particularly suitable for refurbishments or in spaces where lightness and versatility are the main features.

ADVANTAGES

- Installation flush with the floor (it eliminates architectural barriers)
- Possibility of installation close to the wall
- Height of the shower drain of 55 mm (laying surface)
- Suitable for tiles with thickness up to 12 mm
- Possibility of laying tiles with thickness up to 12 mm with Tile Cover
- Shower drains with certification EN 1253-1 (minimum flow rate of 24 l/min)
- Supports for quick installation
- Integrated waterproof membrane to reduce the risk of seepages
- Possibility of inspection of the syphon for periodic cleaning
- Filter for cleaning/hair
- Quick installation
- Drain adapter from 4 to 50 mm included

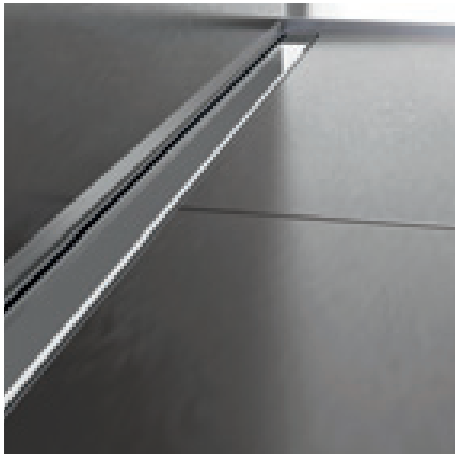

classic cover - polished stainless steel AISI 304 - DIN 1.4301

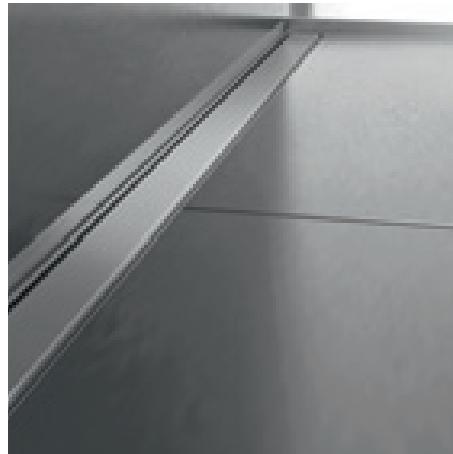

classic cover - brushed stainless steel AISI 304 - DIN 1.4301

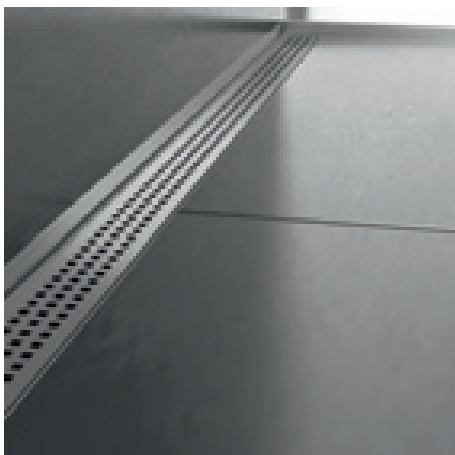

cube cover - brushed stainless steel AISI 304 - DIN 1.4301

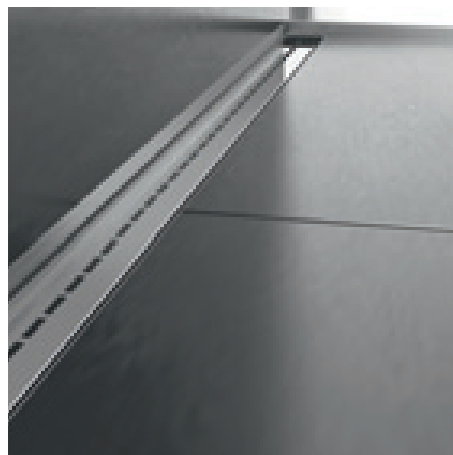

single line cover - polished stainless steel AISI 304 - DIN 1.4301



THIN DRAIN - BASE - pack 10 pcs

| ART. | finishing | | 60 cm | 70 cm | 80 cm | 90 cm | 100 cm | 120 cm |
|------------------------|--|--|-------|-------|-------|-------|--------|--------|
| STAINLESS STEEL | | | | | | | | |
| THIN/ | stainless steel AISI 304 DIN 1.4301 | | 19400 | 19401 | 19402 | 19403 | 19404 | 19405 |
| <i>euro/pc</i> | | | | | | | | |



CLASSIC COVER - pack 10 pcs

| ART. | finishing | | 60 cm | 70 cm | 80 cm | 90 cm | 100 cm | 120 cm |
|------------------------|---|--|-------|-------|-------|-------|--------|--------|
| STAINLESS STEEL | | | | | | | | |
| XTC/ | brushed stainless steel AISI 304 DIN 1.4301 | | 19410 | 19412 | 19414 | 19416 | 19418 | 19420 |
| | polished stainless steel AISI 304 DIN 1.4301 | | 19411 | 19413 | 19415 | 19417 | 19419 | 19421 |
| <i>euro/pc</i> | | | | | | | | |



CUBE COVER - pack 10 pcs

| ART. | finishing | | 60 cm | 70 cm | 80 cm | 90 cm |
|------------------------|--|--|-------|-------|-------|-------|
| STAINLESS STEEL | | | | | | |
| XTCC/ | brushed stainless steel AISI 304 DIN 1.4301 | | 19430 | 19431 | 19432 | 19433 |
| <i>euro/pc</i> | | | | | | |



SINGLE LINE COVER - pack 10 pcs

| ART. | finishing | | 60 cm | 70 cm | 80 cm | 90 cm |
|----------------|---|--|-------|-------|-------|-------|
| XTL/ | polished stainless steel AISI 304 DIN 1.4301 | | 19440 | 19441 | 19442 | 19443 |
| <i>euro/pc</i> | | | | | | |



TILE COVER - pack 10 pcs

| ART. | finishing | | 60 cm | 70 cm | 80 cm | 90 cm |
|----------------|--|--|-------|-------|-------|-------|
| XTT/ | stainless steel AISI 304 DIN 1.4301 | | 19450 | 19451 | 19452 | 19453 |
| <i>euro/pc</i> | | | | | | |

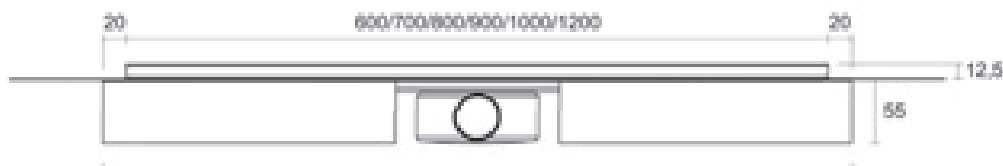
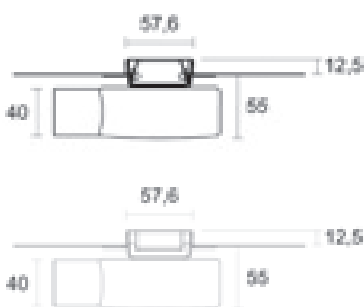
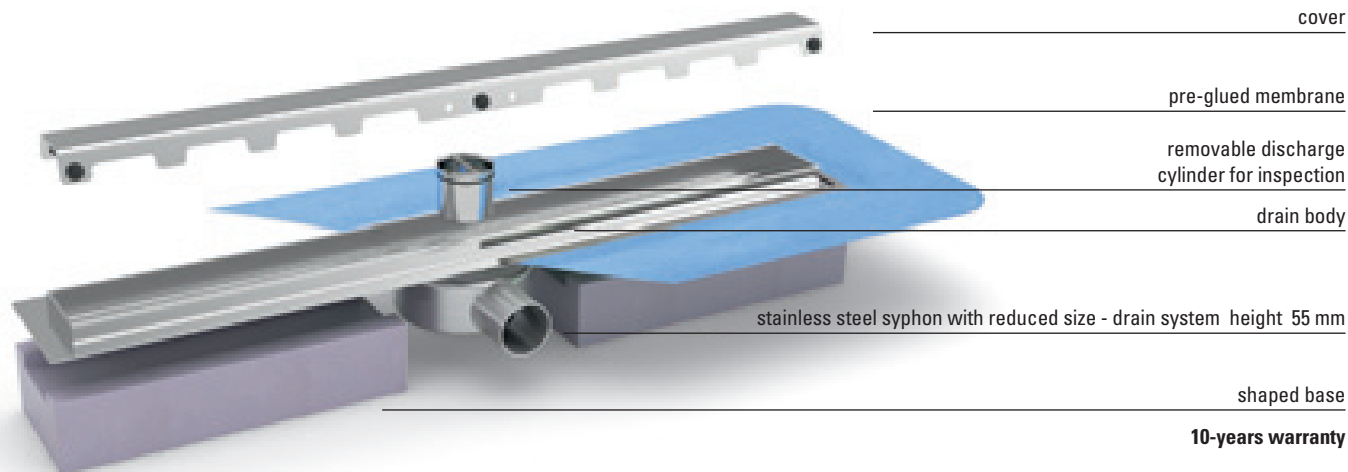

slim drain

slimdrain

Slim Drain is a line of flush with the floor shower drains for a quick and easy installation, which allows to customize the shower with any kind of covering and any tile thickness by choosing Slim Drain Invisible. Thanks to the syphon with low thickness and the height of the shower drain of just 65 mm, they are particularly suitable for refurbishments or in spaces where lightness and versatility are the main features.

ADVANTAGES

- Installation flush with the floor (it eliminates architectural barriers)
- Possibility of installation close to the wall
- Height of the shower drain of 65 mm (laying surface)
- Suitable for any tile thickness (Slim Invisible version)
- Adjustable frame (thickness 7-12,5 mm), Slim Invisible excluded.
- Shower drains with certification EN 1253-1 (minimum flow rate of 24 l/min)
- Integrated adjusting supports for an easy levelling
- Integrated waterproof membrane to reduce the risk of seepages
- Possibility of inspection of the syphon for periodic cleaning
- Filter for cleaning/hair
- Quick installation
- Drain adapter from 40 to 50 mm included

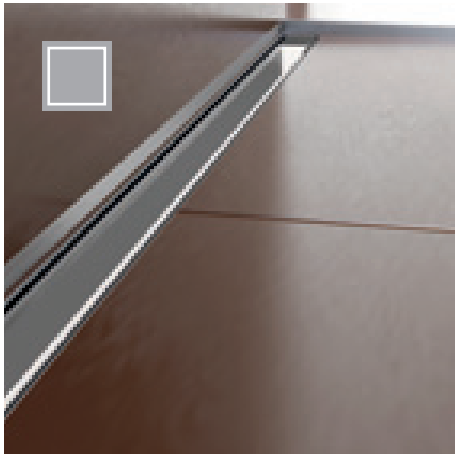

classic cover - polished stainless steel AISI 304 DIN 1.4301



classic cover - brushed stainless steel AISI 304 DIN 1.4301

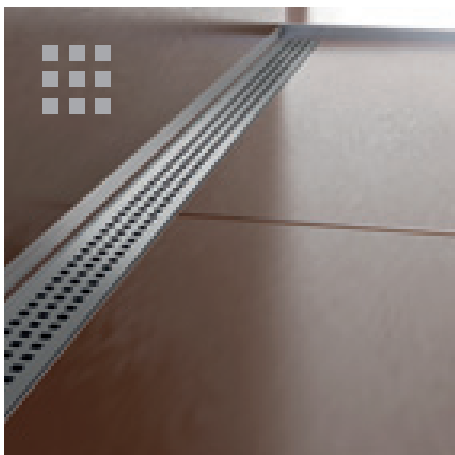

cube cover - brushed stainless steel AISI 304 DIN 1.4301

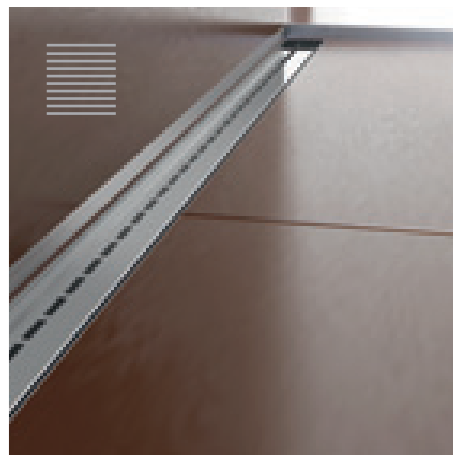

single line cover - polished stainless steel AISI 304 DIN 1.4301

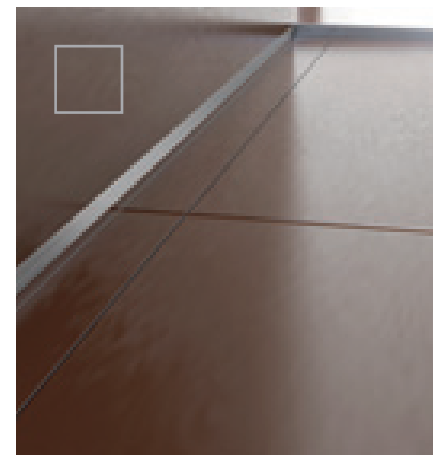

slim invisible - stainless steel AISI 304 DIN 1.4301



SLIM DRAIN - BASE - pack 10 pcs

| ART. | finishing | | 60 cm | 70 cm | 80 cm | 90 cm | 100 cm | 120 cm |
|------------------------|--|--|-------|-------|-------|-------|--------|--------|
| STAINLESS STEEL | | | | | | | | |
| SLIM/ | stainless steel AISI 304 DIN 1.4301 | | 19504 | 19506 | 19508 | 19510 | 19512 | 19514 |
| <i>euro/pc</i> | | | | | | | | |

CLASSIC COVER - pack 10 pcs

| ART. | finishing | | 60 cm | 70 cm | 80 cm | 90 cm | 100 cm | 120 cm |
|------------------------|---|--|-------|-------|-------|-------|--------|--------|
| STAINLESS STEEL | | | | | | | | |
| XSC/ | brushed stainless steel AISI 304 DIN 1.4301 | | 19524 | 19526 | 19528 | 19530 | 19532 | 19534 |
| | polished stainless steel AISI 304 DIN 1.4301 | | 19523 | 19525 | 19527 | 19529 | 19531 | 19533 |
| <i>euro/pc</i> | | | | | | | | |

CUBE COVER - pack 10 pcs

| ART. | finishing | | 60 cm | 70 cm | 80 cm | 90 cm |
|------------------------|--|--|-------|-------|-------|-------|
| STAINLESS STEEL | | | | | | |
| XSCC/ | brushed stainless steel AISI 304 DIN 1.4301 | | 19544 | 19546 | 19548 | 19550 |
| <i>euro/pc</i> | | | | | | |

SINGLE LINE COVER - pack 10 pcs

| ART. | finishing | | 60 cm | 70 cm | 80 cm | 90 cm |
|----------------|---|--|-------|-------|-------|-------|
| XSL/ | polished stainless steel AISI 304 DIN 1.4301 | | 19563 | 19565 | 19567 | 19569 |
| <i>euro/pc</i> | | | | | | |

SLIM INVISIBLE - BASE + COVER - pack 10 pcs

| ART. | finishing | | 60 cm | 70 cm | 80 cm | 90 cm |
|----------------|--|--|-------|-------|-------|-------|
| SLIM-I/ | stainless steel AISI 304 DIN 1.4301 | | 19505 | 19507 | 19509 | 19511 |
| <i>euro/pc</i> | | | | | | |

Slim Invisible does not include the adjustable frame

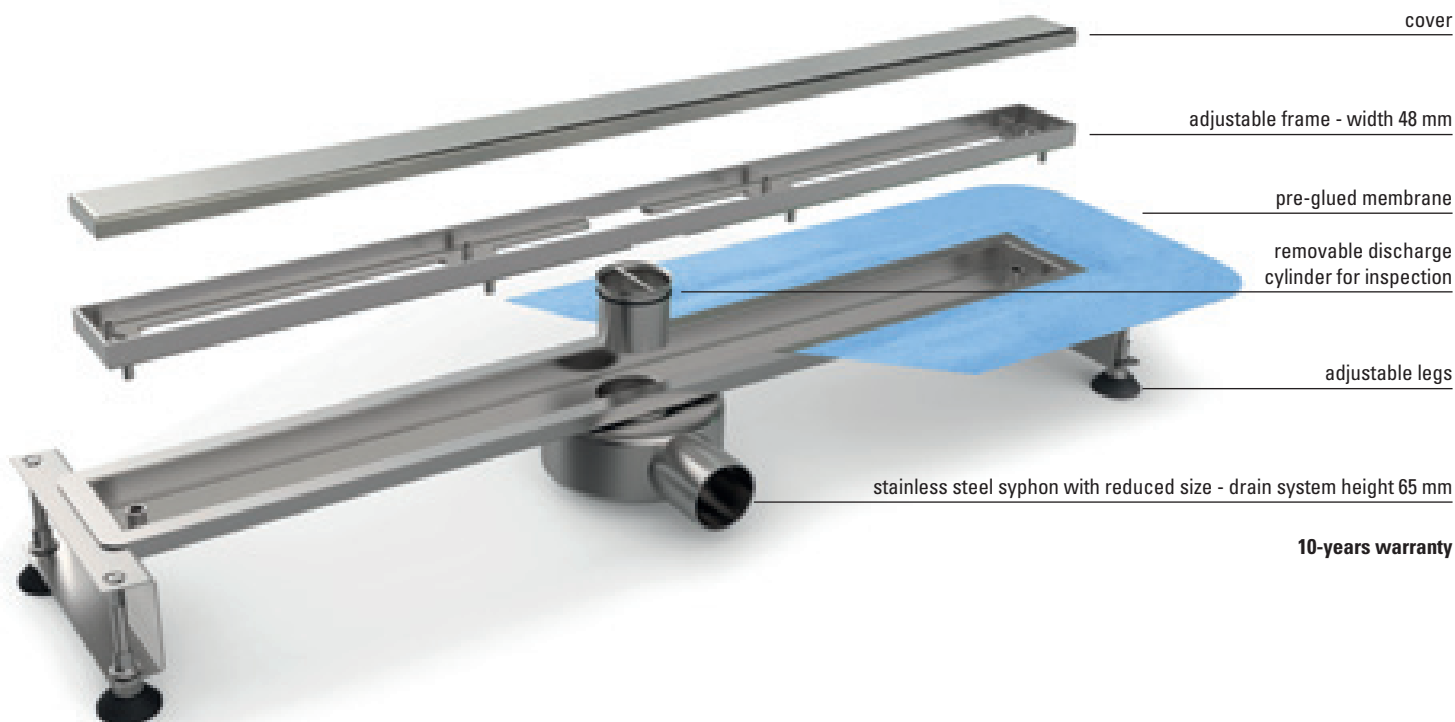
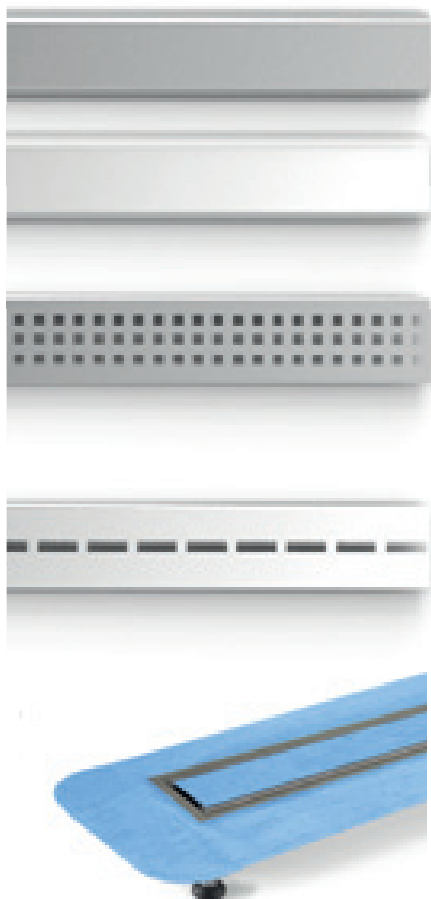

cover

adjustable frame - width 48 mm

pre-glued membrane

removable discharge cylinder for inspection

adjustable legs

stainless steel syphon with reduced size - drain system height 65 mm

10-years warranty

smart drain

smartdrain

Smart Drain is a line of flush with the floor shower drains for a quick and easy installation, which allows to customize the shower with any kind of covering and any tile thickness by choosing Smart Drain Invisible. With high aesthetic level, varied sizes available and the height of the shower drain of 75 mm, they are particularly suitable for large size of tiles in every space.

ADVANTAGES

- Installation flush with the floor (it eliminates architectural barriers)
- Possibility of installation close to the wall
- Height of the shower drain of 75 mm (laying surface)
- Suitable for tiles with every tiles thickness (Smart Invisible version)
- Adjustable frame (thickness 7-12,5 mm), excluded Smart Invisible.
- Orientable siphoned body.
- Shower drains with certification EN 1253-1 (minimum flow rate of 24 l/min)
- Integrated regular supports for a simple set - aside at the same level.
- Integrated waterproof membrane to reduce the risk of seepages
- Suitable Inox stain steel AISI 316 - DIN 14404 version
- 180° Ruotatable classic cover for tiles (maximum thickness 10 mm)
- Possibility of inspection of the syphon for periodic cleaning
- Filter for cleaning/hair
- Quick installation



classic cover - polished stainless steel AISI 304 DIN 1.4301

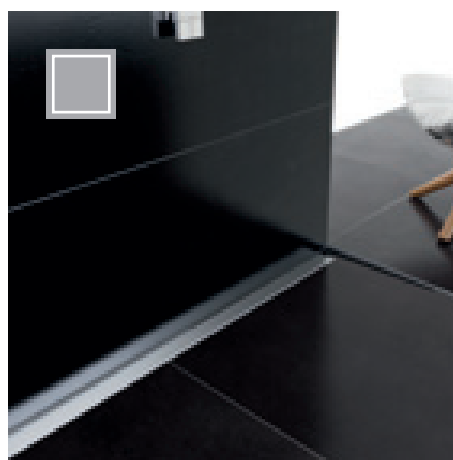

classic cover - brushed stainless steel AISI 304 DIN 1.4301

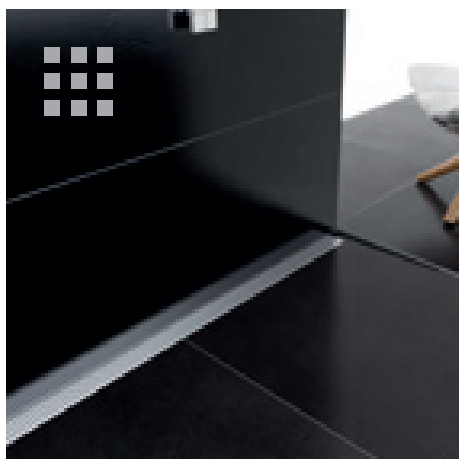

cube cover - brushed stainless steel AISI 304 DIN 1.4301



double line cover - polished stainless steel AISI 304 DIN 1.4301

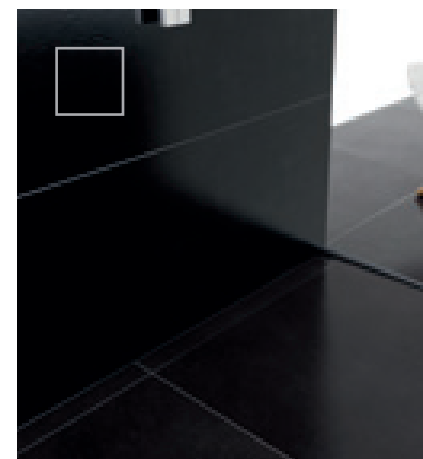

smart invisible - stainless steel AISI 304 DIN 1.4301



SMART DRAIN - BASE - pack 10 pcs

| ART. | finishing | | 70 cm | 80 cm | 90 cm | 100 cm | 110 cm | 120 cm |
|------------------------|--|--|-------|-------|-------|--------|--------|--------|
| STAINLESS STEEL | | | | | | | | |
| SMART/ | stainless steel AISI 304 DIN 1.4301 | | 19704 | 19706 | 19708 | 19710 | 19712 | 19714 |
| | <i>euro/pc</i> | | | | | | | |
| SMART3/ | stainless steel AISI 316 DIN 1.4404 | | 19715 | 19716 | 19717 | 19718 | - | - |
| | <i>euro/pc</i> | | | | | | - | - |

CLASSIC COVER - pack 10 pcs

| ART. | finishing | | 70 cm | 80 cm | 90 cm | 100 cm | 110 cm | 120 cm |
|------------------------|---|--|-------|-------|-------|--------|--------|--------|
| STAINLESS STEEL | | | | | | | | |
| XLC/ | brushed stainless steel AISI 304 DIN 1.4301 | | 19724 | 19726 | 19728 | 19730 | 19732 | 19734 |
| | polished stainless steel AISI 304 DIN 1.4301 | | 19723 | 19725 | 19727 | 19729 | 19731 | 19733 |
| | <i>euro/pc</i> | | | | | | | |
| XLC3/ | brushed stainless steel AISI 316 DIN 1.4404 | | 19741 | 19742 | 19743 | 19744 | - | - |
| | <i>euro/pc</i> | | | | | | - | - |

CUBE COVER - pack 10 pcs

| ART. | finishing | | 70 cm | 80 cm | 90 cm | 100 cm | 110 cm | 120 cm |
|------------------------|--|--|-------|-------|-------|--------|--------|--------|
| STAINLESS STEEL | | | | | | | | |
| XLCC/ | brushed stainless steel AISI 304 DIN 1.4301 | | 19764 | 19766 | 19768 | 19770 | 19772 | 19774 |
| | <i>euro/pc</i> | | | | | | | |

DOUBLE LINE COVER - pack 10 pcs

| ART. | finishing | | 70 cm | 80 cm | 90 cm | 100 cm | 110 cm | 120 cm |
|------------------------|---|--|-------|-------|-------|--------|--------|--------|
| STAINLESS STEEL | | | | | | | | |
| XLL/ | polished stainless steel AISI 304 DIN 1.4301 | | 19783 | 19785 | 19787 | 19789 | 19791 | 19793 |
| | <i>euro/pc</i> | | | | | | | |

SMART INVISIBLE - BASE + COVER - pack 10 pcs

| ART. | finishing | | 70 cm | 80 cm | 90 cm | 100 cm | 110 cm | 120 cm |
|------------------------|--|--|-------|-------|-------|--------|--------|--------|
| STAINLESS STEEL | | | | | | | | |
| SMART-I/ | stainless steel AISI 304 DIN 1.4301 | | 19703 | 19705 | 19707 | 19709 | 19711 | 19713 |
| | <i>euro/pc</i> | | | | | | | |

Smart Invisible does not include the adjustable frame

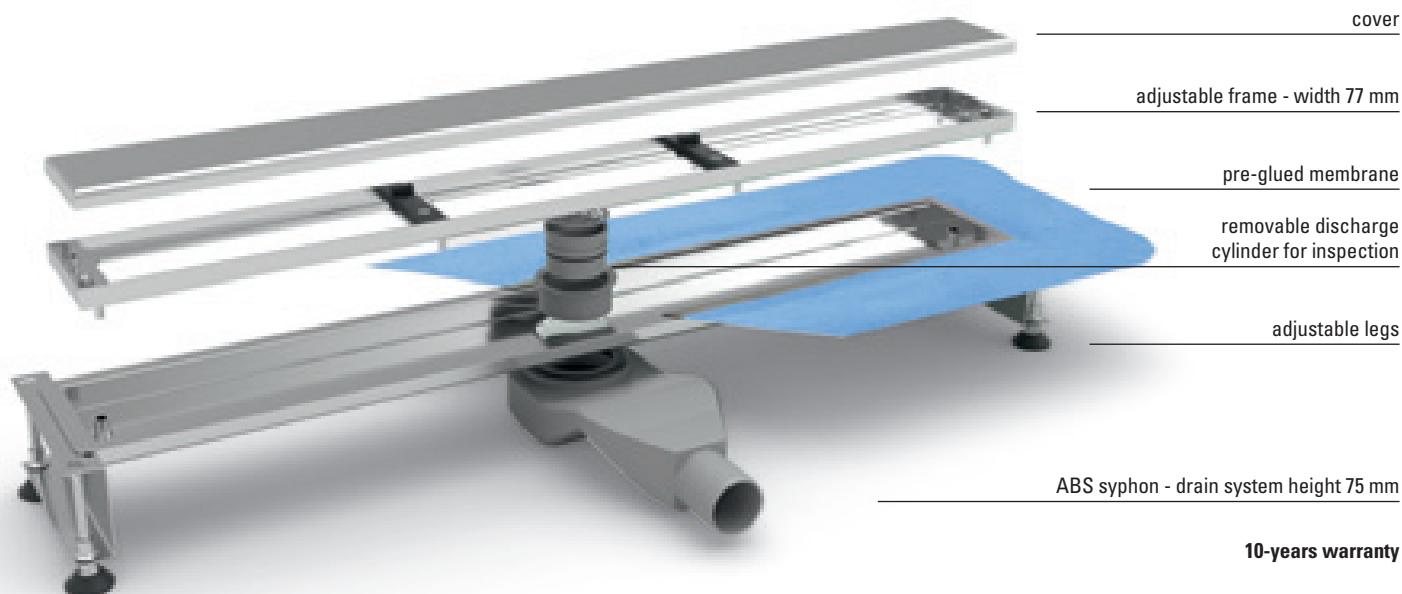

10-years warranty

Q drain

q-drain

Q-Drain is a line of point drainages for flush with the floor showers which are quick and easy to install and allow to customize the shower with any kind of covering. Provided with insulating flange and with a height of 72/78 mm, they are the ideal solution for traditional showers flush with the floor.

ADVANTAGES

- Installation flush with the floor (it eliminates architectural barriers)
- Height of the point drainage of 72/78 mm (laying surface)
- Directable syphon
- Shower drains with certification EN 1253-1 (minimum flow rate of 24 l/ min)
- Integrated waterproof membrane to reduce the risk of seepages
- Possibility of laying tiles with thickness up to 10 mm with Q Drain Tile
- Possibility of inspection of the syphon for periodic cleaning
- Filter for cleaning/hair
- Quick installation

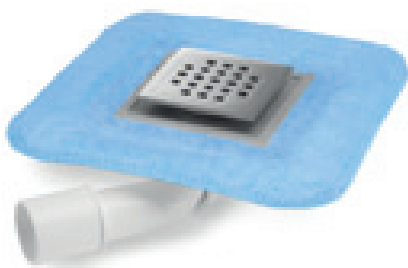

Q Drain Cube



Q Drain Line



Q DRAIN CLASSIC - pack 10 pcs

| ART. | finishing | 10x10 cm |
|-----------------------------------|---|----------|
| STAINLESS STEEL | | |
| floor thickness of 12,5 mm | | |
| QDC/1010 | brushed stainless steel AISI 304 DIN 1.4301 | 19850 |
| | polished stainless steel AISI 304 DIN 1.4301 | 19851 |
| <i>euro/pc</i> | | |

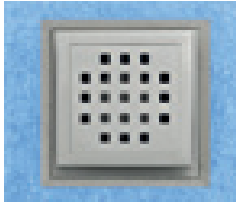

Q DRAIN CUBE - pack 10 pcs

| ART. | finishing | 10x10 cm |
|-----------------------------------|---|----------|
| STAINLESS STEEL | | |
| floor thickness of 12,5 mm | | |
| QDCC/1010 | brushed stainless steel AISI 304 DIN 1.4301 | 19852 |
| | polished stainless steel AISI 304 DIN 1.4301 | 19853 |
| <i>euro/pc</i> | | |



Q DRAIN LINE - pack 10 pcs

| ART. | finishing | 10x10 cm |
|-----------------------------------|---|----------|
| STAINLESS STEEL | | |
| floor thickness of 12,5 mm | | |
| QDL/1010 | brushed stainless steel AISI 304 DIN 1.4301 | 19854 |
| | polished stainless steel AISI 304 DIN 1.4301 | 19855 |
| <i>euro/pc</i> | | |

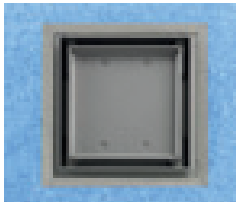

Q DRAIN TILE - pack 10 pcs

| ART. | finishing | 10x10 cm |
|---------------------------------|--|----------|
| STAINLESS STEEL | | |
| floor thickness of 10 mm | | |
| QDI/1010 | stainless steel AISI 304 DIN 1.4301 | 19856 |
| <i>euro/pc</i> | | |

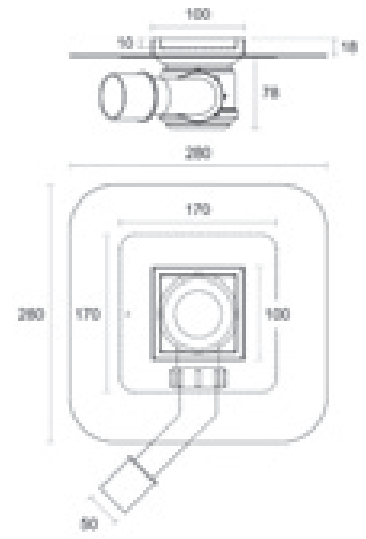
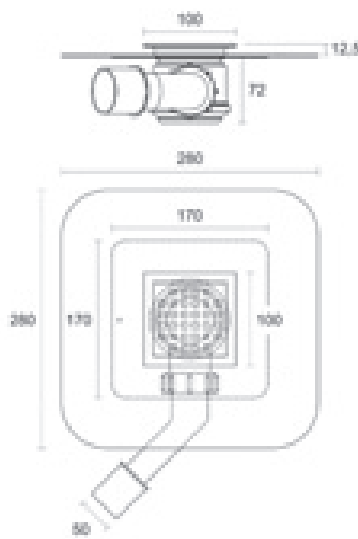
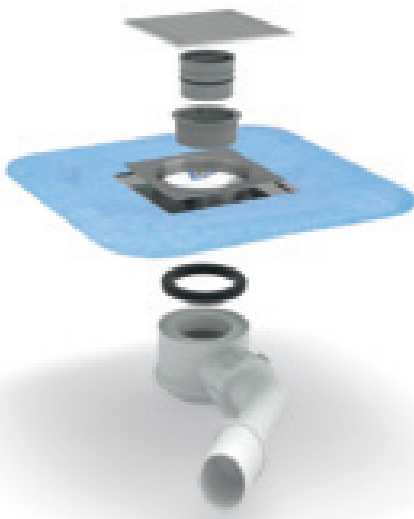

10-years warranty

Glass Profile

The floor-level shower is a trendy and design element that represents a real opportunity for designing bathrooms of every dimension, highlighting their practicality and beauty. Removing the traditional shower tray, the floor-level shower can be made with the same covering of the bathroom, thus creating a uniform and elegant surface. Moreover, the absence of architectural barriers makes the access easier for children, elderly people or disabled.

Profilpas offers a series of integrated solutions for floor-level showers: a system of linear floor-level drains in stainless steel, with the possibility of also opting for the invisible version, thus creating a whole with the shower ceramic covering, which is completed by a wide range of stainless steel profiles for the insertion of glass walls and for finishing the sloping surface.



Glass Profile is a line of stainless steel profiles designed to cover the difference in height of the surface with 2% slope and create a coplanar surface with a modern and linear design. The range includes two finishes: brushed stainless steel and matt black colour coated stainless steel. The versatility of these two colours become guarantee of elegance, assuring a minimalist and trendy effect.

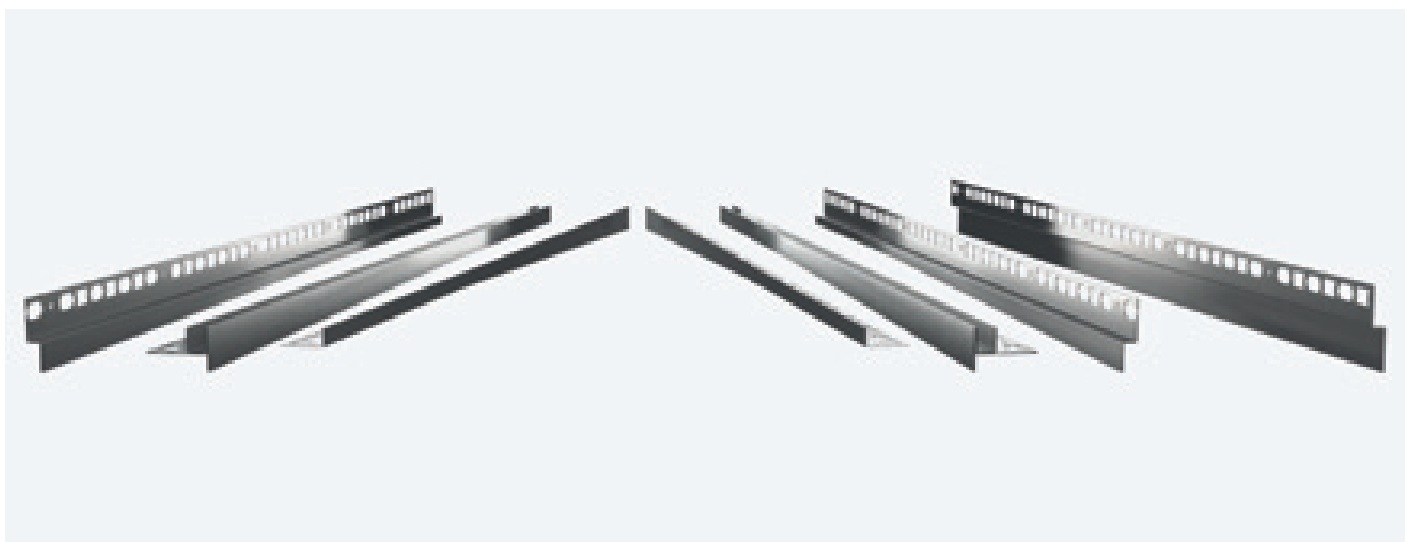

glass profile

Glass Profile GPS1/ is a stainless steel profile for the insertion of glass walls of floor-level showers. GPS1/ is provided with a 2% slope on the shower inner side for a perfect aesthetic solution of the sloped surface.

On completion of the profile, there is GPS/6, the end cap for hiding the section of the glass wall.

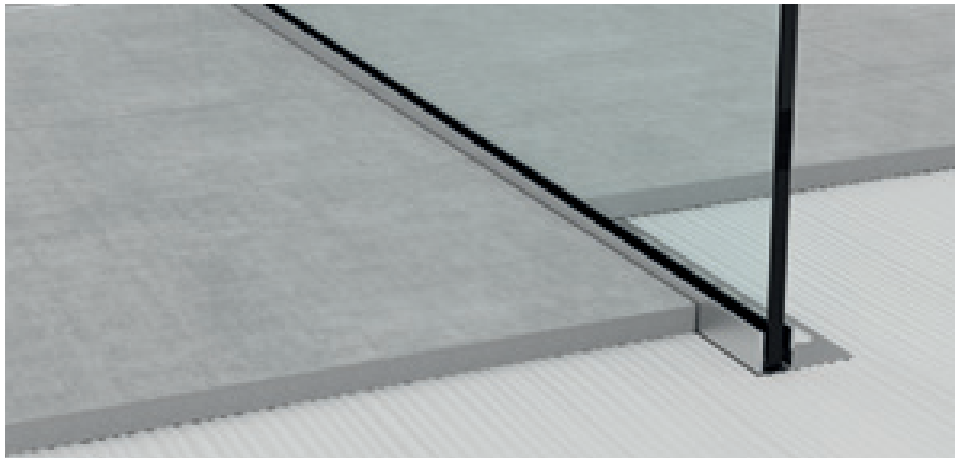

GPS1/DX/19 brushed stainless steel AISI 304 DIN 1.4301

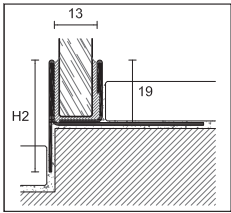

GPS1/DX/19

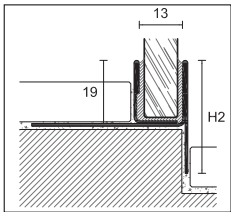

GPS1/SX/19

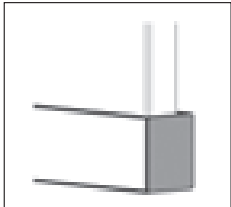

GPS/6

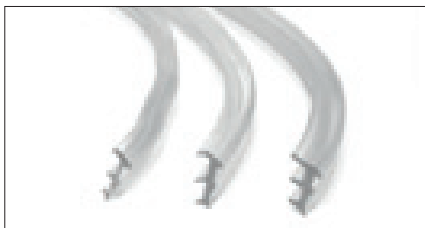

silicone glazing beads

GLASS PROFILE

pack 5 pcs

| ART. | GPS1/ /19 | | | | | | | |
|-----------|-----------|--|-----|--|-----|--|-----|--|
| | DX | | SX | | DX | | SX | |
| length cm | 98 | | 120 | | 148 | | 200 | |
| H2 mm | 34 | | 37 | | 42 | | 60 | |

STAINLESS STEEL

| | | | | | | | | | |
|---|--|-------|-------|-------|-------|-------|-------|-------|-------|
| brushed stainless steel AISI 304 DIN 1.4301 | | 31505 | 31507 | 31515 | 31517 | 31525 | 31527 | 31535 | 31537 |
|---|--|-------|-------|-------|-------|-------|-------|-------|-------|

euro/pc

MATT BLACK COLOUR-COATED STAINLESS STEEL

| | | | | | | | | | |
|---|--|-------|-------|-------|-------|-------|-------|---|---|
| matt black RAL 9005 colour-coated stainless steel AISI 304 DIN 1.4301 | | 31506 | 31508 | 31516 | 31518 | 31526 | 31528 | - | - |
|---|--|-------|-------|-------|-------|-------|-------|---|---|

euro/pc

individually packed

GLASS PROFILE - END CAP FOR GPS1/ /19

pack 5 pcs

| ART. | GPS/6 | |
|------|---|--|
| | brushed stainless steel AISI 304 DIN 1.4301 | |

euro/pc

MATT BLACK COLOUR-COATED STAINLESS STEEL

| | | |
|---|--|-------|
| matt black RAL 9005 colour-coated stainless steel AISI 304 DIN 1.4301 | | 31566 |
|---|--|-------|

euro/pc

no partial packaging

TRANSPARENT SILICONE GLAZING BEADS

pack 5 mt

| ART. | measures | |
|------|----------------|-------|
| GG/2 | thickness 2 mm | 31590 |
| | euro/pack | |
| GG/3 | thickness 3 mm | 31592 |
| | euro/pack | |
| GG/4 | thickness 4 mm | 31594 |
| | euro/pack | |

no partial packaging

Complete the article code with DX and SX (DX = RH and SX = LH) - for example GPS1//19 RH becomes GPS1/DX/19.

Glass Profile GPS2/ and GPS14/12 are two stainless steel profiles for inserting glass walls on the wall covering. GPS2/ is simple to install, is suitable for tiles of any thickness and does not require drilling. GPS/6 is the end cap to complete the profile, to hide the visible section of the glass wall. GPS14/12 can be fixed directly onto the already-laid wall covering.



GPS2/19 brushed stainless steel AISI 304 DIN 1.4301

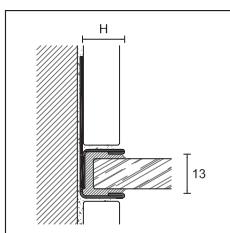

GPS2/



GLASS PROFILE

length = 210 cm - pack 5 pcs

| ART. | finishing | 10 | 12,5 | 19 |
|------|-----------|----|------|----|
|------|-----------|----|------|----|

STAINLESS STEEL

| | | | | | |
|----------------|--|--|-------|-------|-------|
| GPS2/ | brushed stainless steel AISI 304 DIN 1.4301 | | 31541 | 31542 | 31543 |
| <i>euro/pc</i> | | | | | |

MATT BLACK COLOUR-COATED STAINLESS STEEL

| | | | | | |
|----------------|---|--|-------|-------|-------|
| GPS2/ | matt black RAL 9005 colour-coated stainless steel AISI 304 DIN 1.4301 | | 31546 | 31547 | 31545 |
| <i>euro/pc</i> | | | | | |

individually packed

GLASS PROFILE

length = 250 cm - pack 5 pcs

| ART. | finishing | 10 | 12,5 | 19 |
|------|-----------|----|------|----|
|------|-----------|----|------|----|

STAINLESS STEEL

| | | | | | |
|----------------|--|--|-------|-------|-------|
| GPS2/ | brushed stainless steel AISI 304 DIN 1.4301 | | 31548 | 31549 | 31544 |
| <i>euro/pc</i> | | | | | |

individually packed

GLASS PROFILE - END CAP FOR GPS2/19

pack 5 pcs

| ART. | GPS/6 |
|------|-------|
|------|-------|

STAINLESS STEEL

| | | | |
|----------------|--|--|-------|
| | brushed stainless steel AISI 304 DIN 1.4301 | | 31564 |
| <i>euro/pc</i> | | | |

MATT BLACK COLOUR-COATED STAINLESS STEEL

| | | | |
|----------------|---|--|-------|
| | matt black RAL 9005 colour-coated stainless steel AISI 304 DIN 1.4301 | | 31566 |
| <i>euro/pc</i> | | | |

no partial packaging

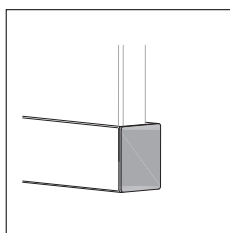

GPS/6

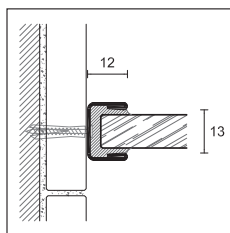

GPS14/12



GLASS PROFILE

pack 5 pcs

| ART. | GPS14/12 |
|------|----------|
|------|----------|

STAINLESS STEEL

| | | | | |
|----------------|--|-----|-------|-------|
| | length cm | 210 | 250 | |
| | brushed stainless steel AISI 304 DIN 1.4301 | | 32000 | 32001 |
| <i>euro/pc</i> | | | | |

individually packed

Complete the article code with H measure (for example GPS2/ for H=10 becomes GPS2/10).

glass profile

Glass Profile GPS3/ is a stainless steel profile provided with a 2% slope on the shower inner side for a perfect aesthetic solution of the sides of the sloped surface.

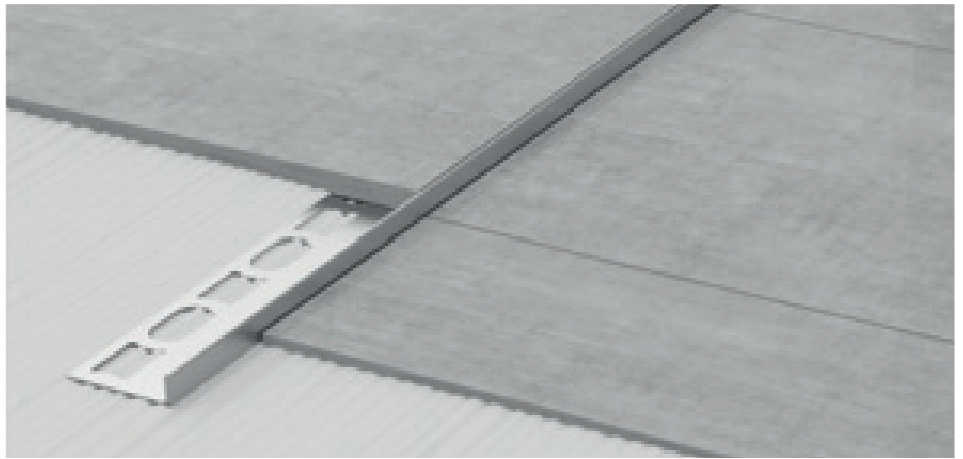

GPS3/SX/10 brushed stainless steel AISI 304 DIN 1.4301

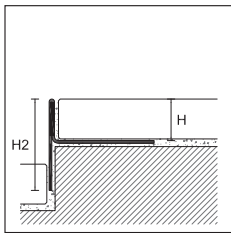

GPS3/DX/

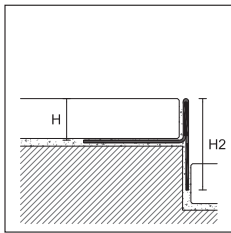

GPS3/SX/



GLASS PROFILE

length = 98 cm - pack 5 pcs

| ART. | finishing | | H | H2 | DX | SX |
|---|---|--|------|------|-------|-------|
| STAINLESS STEEL | | | | | | |
| GPS3/ /10 | brushed stainless steel AISI 304 DIN 1.4301 <i>euro/pc</i> | | 10 | 25 | 31615 | 31617 |
| GPS3/ /11 | brushed stainless steel AISI 304 DIN 1.4301 <i>euro/pc</i> | | 11 | 26 | 31619 | 31620 |
| GPS3/ /12 | brushed stainless steel AISI 304 DIN 1.4301 <i>euro/pc</i> | | 12,5 | 27,5 | 31625 | 31627 |
| MATT BLACK COLOUR-COATED STAINLESS STEEL | | | | | | |
| GPS3/ /10 | matt black RAL 9005 colour-coated stainless steel AISI 304 DIN 1.4301 <i>euro/pc</i> | | 10 | 25 | 31616 | 31618 |
| GPS3/ /11 | matt black RAL 9005 colour-coated stainless steel AISI 304 DIN 1.4301 <i>euro/pc</i> | | 11 | 26 | 31629 | 31630 |
| GPS3/ /12 | matt black RAL 9005 colour-coated stainless steel AISI 304 DIN 1.4301 <i>euro/pc</i> | | 12,5 | 27,5 | 31626 | 31628 |

individually packed

GLASS PROFILE

length = 120 cm - pack 5 pcs

| ART. | finishing | | H | H2 | DX | SX |
|---|---|--|------|------|-------|-------|
| STAINLESS STEEL | | | | | | |
| GPS3/ /10 | brushed stainless steel AISI 304 DIN 1.4301 <i>euro/pc</i> | | 10 | 28 | 31645 | 31647 |
| GPS3/ /11 | brushed stainless steel AISI 304 DIN 1.4301 <i>euro/pc</i> | | 11 | 29 | 31649 | 31650 |
| GPS3/ /12 | brushed stainless steel AISI 304 DIN 1.4301 <i>euro/pc</i> | | 12,5 | 30,5 | 31655 | 31657 |
| MATT BLACK COLOUR-COATED STAINLESS STEEL | | | | | | |
| GPS3/ /10 | matt black RAL 9005 colour-coated stainless steel AISI 304 DIN 1.4301 <i>euro/pc</i> | | 10 | 28 | 31646 | 31648 |
| GPS3/ /11 | matt black RAL 9005 colour-coated stainless steel AISI 304 DIN 1.4301 <i>euro/pc</i> | | 11 | 29 | 31652 | 31654 |
| GPS3/ /12 | matt black RAL 9005 colour-coated stainless steel AISI 304 DIN 1.4301 <i>euro/pc</i> | | 12,5 | 30,5 | 31656 | 31658 |







individually packed

GPS3/ is also available in 8 mm height on request, with a minimum order of 30 pcs.

Complete the article code with DX and SX (DX = RH and SX = LH) - for example GPS3/ /10 RH becomes GPS3/DX/10)

GLASS PROFILE



length = 148 cm - pack 5 pcs

| ART. | finishing | | H | H2 | DX | SX |
|---|---|--|------|------|-------|-------|
| STAINLESS STEEL | | | | | | |
| GPS3/ /10 | brushed stainless steel AISI 304 DIN 1.4301 <i>euro/pc</i> |  | 10 | 33 | 31675 | 31677 |
| GPS3/ /11 | brushed stainless steel AISI 304 DIN 1.4301 <i>euro/pc</i> |  | 11 | 34 | 31679 | 31680 |
| GPS3/ /12 | brushed stainless steel AISI 304 DIN 1.4301 <i>euro/pc</i> |  | 12,5 | 35,5 | 31685 | 31687 |
| MATT BLACK COLOUR-COATED STAINLESS STEEL | | | | | | |
| GPS3/ /10 | matt black RAL 9005 colour-coated stainless steel AISI 304 DIN 1.4301 <i>euro/pc</i> |  | 10 | 33 | 31676 | 31678 |
| GPS3/ /11 | matt black RAL 9005 colour-coated stainless steel AISI 304 DIN 1.4301 <i>euro/pc</i> |  | 11 | 34 | 31682 | 31684 |
| GPS3/ /12 | matt black RAL 9005 colour-coated stainless steel AISI 304 DIN 1.4301 <i>euro/pc</i> |  | 12,5 | 35,5 | 31686 | 31688 |

individually packed

GLASS PROFILE

length = 200 cm - pack 5 pcs

| ART. | finishing | | H | H2 | DX | SX |
|------------------------|--|--|------|------|-------|-------|
| STAINLESS STEEL | | | | | | |
| GPS3/ /10 | brushed stainless steel AISI 304 DIN 1.4301 <i>euro/pc</i> |  | 10 | 51 | 31694 | 31695 |
| GPS3/ /12 | brushed stainless steel AISI 304 DIN 1.4301 <i>euro/pc</i> |  | 12,5 | 53,5 | 31698 | 31699 |

individually packed



GPS3/DX/10 matt black RAL 9005 colour-coated stainless steel AISI 304 DIN 1.4301

glass profile

Glass Profile GPS4/ is a stainless steel profile provided with a 2% slope on the shower inner side. It connects the sloped floor and the covering perfectly, thus avoiding the oblique cut of the tiles.



GPS4/DX/10 matt black RAL 9005 colour-coated stainless steel AISI 304 DIN 1.4301

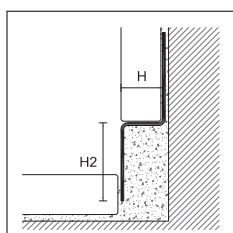

GPS4/DX/

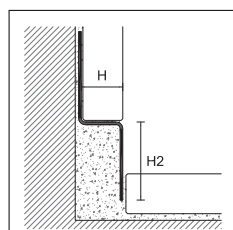

GPS4/SX/

GLASS PROFILE

length = 98 cm - pack 5 pcs

| ART. | finishing | H | H2 | DX | SX | |
|------------------------|--|--|----|------|-------|-------|
| STAINLESS STEEL | | | | | | |
| GPS4/ /10 | brushed stainless steel AISI 304 DIN 1.4301 | | 10 | 23 | 31715 | 31717 |
| | <i>euro/pc</i> | | | | | |
| | GPS4/ /11 | brushed stainless steel AISI 304 DIN 1.4301 | | 11 | 23 | 31716 |
| <i>euro/pc</i> | | | | | | |
| GPS4/ /12 | | brushed stainless steel AISI 304 DIN 1.4301 | | 12,5 | 23 | 31725 |
| | <i>euro/pc</i> | | | | | |

MATT BLACK COLOUR-COATED STAINLESS STEEL

| | | | | | | |
|----------------|---|---|----|------|-------|-------|
| GPS4/ /10 | matt black RAL 9005 colour-coated stainless steel AISI 304 DIN 1.4301 | | 10 | 23 | 31719 | 31720 |
| | <i>euro/pc</i> | | | | | |
| | GPS4/ /11 | matt black RAL 9005 colour-coated stainless steel AISI 304 DIN 1.4301 | | 11 | 23 | 31722 |
| <i>euro/pc</i> | | | | | | |
| GPS4/ /12 | | matt black RAL 9005 colour-coated stainless steel AISI 304 DIN 1.4301 | | 12,5 | 23 | 31726 |
| | <i>euro/pc</i> | | | | | |

individually packed

GLASS PROFILE

length = 120 cm - pack 5 pcs

| ART. | finishing | H | H2 | DX | SX | |
|------------------------|--|--|----|------|-------|-------|
| STAINLESS STEEL | | | | | | |
| GPS4/ /10 | brushed stainless steel AISI 304 DIN 1.4301 | | 10 | 26 | 31745 | 31747 |
| | <i>euro/pc</i> | | | | | |
| | GPS4/ /11 | brushed stainless steel AISI 304 DIN 1.4301 | | 11 | 26 | 31746 |
| <i>euro/pc</i> | | | | | | |
| GPS4/ /12 | | brushed stainless steel AISI 304 DIN 1.4301 | | 12,5 | 26 | 31755 |
| | <i>euro/pc</i> | | | | | |

GPS4/ is also available in 8 mm height on request, with a minimum order of 30 pcs.

Completare codice articolo con DX e SX (for example GPS4/ /8 DX becomes GPS4/DX/8)

MATT BLACK COLOUR-COATED STAINLESS STEEL

| | | | | | | |
|------------------|---|---|------|----|-------|-------|
| GPS4/ /10 | matt black RAL 9005 colour-coated stainless steel AISI 304 DIN 1.4301 <i>euro/pc</i> | ■ | 10 | 26 | 31749 | 31750 |
| GPS4/ /11 | matt black RAL 9005 colour-coated stainless steel AISI 304 DIN 1.4301 <i>euro/pc</i> | ■ | 11 | 26 | 31752 | 31754 |
| GPS4/ /12 | matt black RAL 9005 colour-coated stainless steel AISI 304 DIN 1.4301 <i>euro/pc</i> | ■ | 12,5 | 26 | 31756 | 31758 |

individually packed

GLASS PROFILE

length = 148 cm - pack 5 pcs

| ART. | finishing | | H | H2 | DX | SX |
|------------------------|--|---|------|----|-------|-------|
| STAINLESS STEEL | | | | | | |
| GPS4/ /10 | brushed stainless steel AISI 304 DIN 1.4301 <i>euro/pc</i> | ▨ | 10 | 31 | 31775 | 31777 |
| GPS4/ /11 | brushed stainless steel AISI 304 DIN 1.4301 <i>euro/pc</i> | ▨ | 11 | 31 | 31776 | 31778 |
| GPS4/ /12 | brushed stainless steel AISI 304 DIN 1.4301 <i>euro/pc</i> | ▨ | 12,5 | 31 | 31785 | 31787 |

MATT BLACK COLOUR-COATED STAINLESS STEEL

| | | | | | | |
|------------------|---|---|------|----|-------|-------|
| GPS4/ /10 | matt black RAL 9005 colour-coated stainless steel AISI 304 DIN 1.4301 <i>euro/pc</i> | ■ | 10 | 31 | 31779 | 31780 |
| GPS4/ /11 | matt black RAL 9005 colour-coated stainless steel AISI 304 DIN 1.4301 <i>euro/pc</i> | ■ | 11 | 31 | 31782 | 31784 |
| GPS4/ /12 | matt black RAL 9005 colour-coated stainless steel AISI 304 DIN 1.4301 <i>euro/pc</i> | ■ | 12,5 | 31 | 31786 | 31800 |

individually packed

GLASS PROFILE

length = 200 cm - pack 5 pcs

| ART. | finishing | | H | H2 | DX | SX |
|------------------------|--|---|------|----|-------|-------|
| STAINLESS STEEL | | | | | | |
| GPS4/ /10 | brushed stainless steel AISI 304 DIN 1.4301 <i>euro/pc</i> | ▨ | 10 | 49 | 31794 | 31795 |
| GPS4/ /12 | brushed stainless steel AISI 304 DIN 1.4301 <i>euro/pc</i> | ▨ | 12,5 | 49 | 31798 | 31799 |

individually packed



GPS4/SX/10 brushed stainless steel AISI 304 DIN 1.4301

glass profile

Glass Profile GPS5/ is a stainless steel profile to be positioned on the wall covering, above the shower drain with sloped surface, in order to avoid the cut of the tiles.

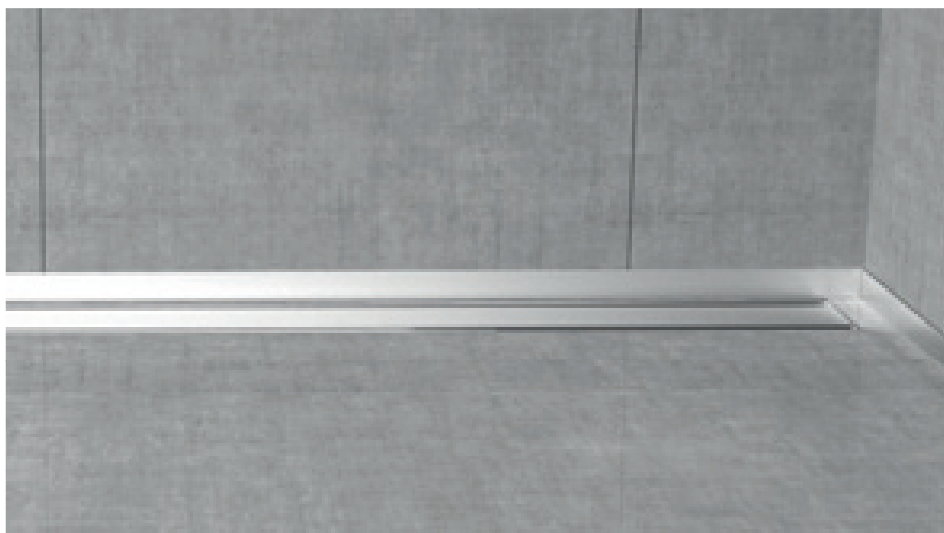

GPS5/ brushed stainless steel AISI 304 DIN 1.4301

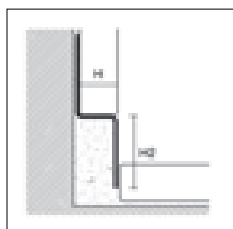







GPS5/



GLASS PROFILE

length = 125 cm - pack 5 pcs

| ART. | finishing | | H | | H2 | |
|---|---|---|------|-----------|-----------|-----------|
| STAINLESS STEEL | | | | | | |
| | | | | 23 | 33 | 45 |
| GPS5/10/ | brushed stainless steel AISI 304 DIN 1.4301 |  | 10 | 31551 | 31553 | 31559 |
| | <i>euro/pc</i> | | | | | |
| GPS5/11/ | brushed stainless steel AISI 304 DIN 1.4301 |  | 11 | 31563 | 31572 | - |
| | <i>euro/pc</i> | | | | | - |
| GPS5/12/ | brushed stainless steel AISI 304 DIN 1.4301 |  | 12,5 | 31555 | 31557 | 31561 |
| | <i>euro/pc</i> | | | | | |
| MATT BLACK COLOUR-COATED STAINLESS STEEL | | | | | | |
| GPS5/10/ | matt black RAL 9005 colour-coated stainless steel AISI 304 DIN 1.4301 |  | 10 | 31567 | 31568 | - |
| | <i>euro/pc</i> | | | | | - |
| GPS5/11/ | matt black RAL 9005 colour-coated stainless steel AISI 304 DIN 1.4301 |  | 11 | 31570 | 31571 | - |
| | <i>euro/pc</i> | | | | | - |
| GPS5/12/ | matt black RAL 9005 colour-coated stainless steel AISI 304 DIN 1.4301 |  | 12,5 | 31573 | 31574 | - |
| | <i>euro/pc</i> | | | | | - |

individually packed

GPS5/ is also available in 8 mm height on request, with a minimum order of 30 pcs.

Complete the article code with H2 measure (for example GPS5/10/ for H2 = 23 becomes GPS5/10/23).



GPS5/ matt black RAL 9005 colour-coated stainless steel AISI 304 DIN 1.4301

GU/ and TGU/ are anodised aluminium profiles suitable for the insertion of glass walls on the floor and on the wall of floor-level showers.

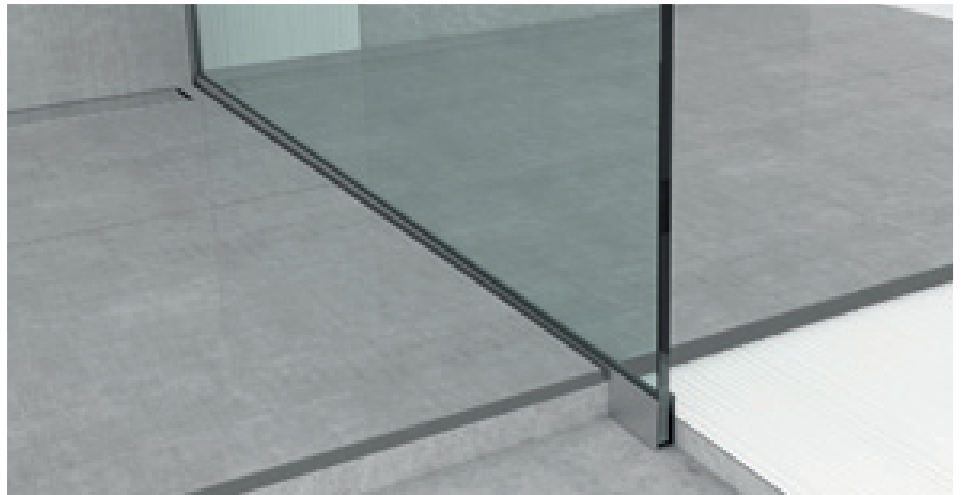

GU/40/12 + TGU/12 silver anodised aluminium

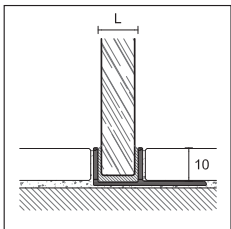

TGU/



GLASS PROFILE

length = 270 cm - pack 10 pcs

| ART. | finishing | 12 | 14 |
|------------------|-----------------|-------|-------|
| ALUMINIUM | | | |
| TGU/ | silver anodised | 67760 | 67762 |
| <i>euro/m</i> | | | |

individually packed

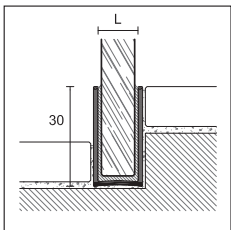

GU/30/

GLASS PROFILE

length = 270 cm - pack 10 pcs

| ART. | finishing | 12 | 14 |
|------------------|-----------------|-------|-------|
| ALUMINIUM | | | |
| GU/30/ | silver anodised | 67770 | 67772 |
| <i>euro/m</i> | | | |

GU/40/ silver anodised

euro/m

individually packed

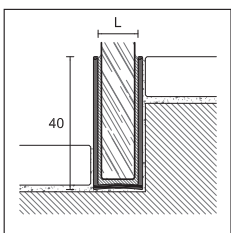

GU/40/

Complete the article code with L measure
(for example GU/30/ per L = 12 becomes
GU/30/12)

sanibord

Sanibord BP/22 and BP/25 are technical profiles in coextruded PVC to be installed between the covering and the bath tub or shower tray during the laying. These profiles allow to avoid the use of silicone and, besides the aesthetic advantages, guarantee a high hygienic level over time.



BP/22



BP/25

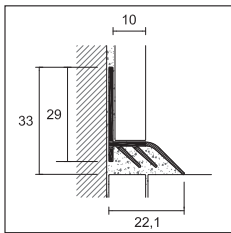

BP/22



SANIBORD

length = 270 cm - pack 20 pcs

ART. finishing

CO-EXTRUDED PVC

BP/22 anti-mould white



95520

euro/m

no partial packaging

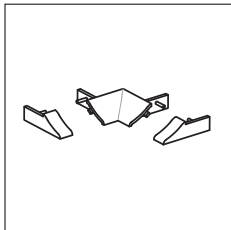

BPT/22

INSIDE CORNER AND RIGHT/LEFT END CAPS FOR BP/22

pack 6 blister

ART. finishing

POLYPROPYLENE

BPT/22 white



95530

euro/blister

no partial packaging

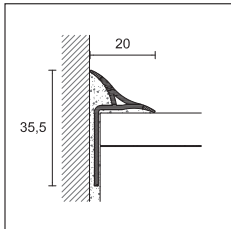

BP/25

SANIBORD

length = 270 cm - pack 20 pcs

ART. finishing

CO-EXTRUDED PVC

BP/25 anti-mould white



95540

euro/m

no partial packaging

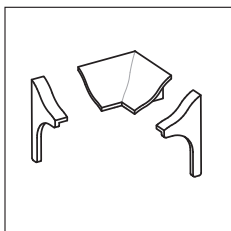

BPT/25

INSIDE CORNER AND RIGHT/LEFT END CAPS FOR BP/25

pack 6 blister

ART. finishing

POLYPROPYLENE

BPT/25 white



95545

euro/blister

no partial packaging

KIT: 1 PC OF 180 CM + 2 PCS OF 90 CM + 2 INSIDE CORNERS AND RIGHT/LEFT END CAPS

pack 10 pcs

ART. finishing

CO-EXTRUDED PVC

BPK/25 anti-mould white



95494

euro/kit

individually packed - no partial packaging

Sanibord BH/20 and BP/20 are technical profiles in colour-coated aluminium and coextruded PVC to be installed between the covering and the bath tub or the shower tray. These profiles allow to avoid the use of silicone and, besides the aesthetic advantages, guarantee a high hygienic level over time.

BH/20 in colour-coated aluminium is provided with the certified antibacterial technology (in compliance with ISO 22196:2011 standards) which allows to reduce the presence of the most dangerous bacteria up to 99%.



BP/20 anti-mould white co-extruded PVC

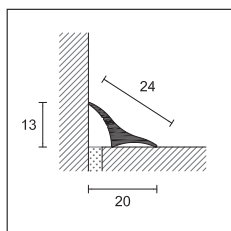

BH/20

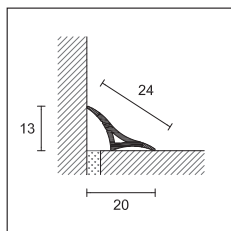

BP/20

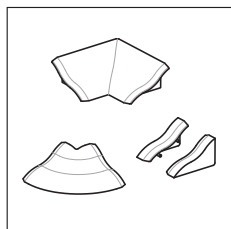

BPT/20

SANIBORD

length = 270 cm - pack 20 pcs

ART. finishing

ANTIBACTERIAL COLOUR-COATED ALUMINIUM

| | | | |
|-------------------------|--|--------------------------|-------|
| BH/20 | colour-coated white antibacterial RAL 9003 | <input type="checkbox"/> | 95459 |
| euro/m | | | |
| BH/20/A adhesive | colour-coated white antibacterial RAL 9003 | <input type="checkbox"/> | 95460 |
| euro/m | | | |

SANIBORD

length = 270 cm - pack 20 pcs

ART. finishing

CO-EXTRUDED PVC

| | | | |
|-------------------------|------------------|--------------------------|-------|
| BP/20 | anti-mould white | <input type="checkbox"/> | 95490 |
| euro/m | | | |
| BP/20/A adhesive | anti-mould white | <input type="checkbox"/> | 95470 |
| euro/m | | | |

no partial packaging

INSIDE CORNER, OUTSIDE CORNER, RIGHT/LEFT END CAPS FOR BH/20 AND BP/20

pack 6 blister

ART. finishing

POLYPROPYLENE

| | | | |
|---------------------|-------|--------------------------|-------|
| BPT/20 | white | <input type="checkbox"/> | 95480 |
| euro/blister | | | |

no partial packaging

KIT: 1 PC OF 180 CM + 2 PCS OF 90 CM + 2 INSIDE CORNERS AND RIGHT/LEFT END CAPS

pack 10 pcs

ART. finishing

CO-EXTRUDED PVC

| | | | |
|-----------------|------------------|--------------------------|-------|
| BPK/20 | anti-mould white | <input type="checkbox"/> | 95544 |
| euro/kit | | | |

individually packed excepted BP20 - no partial packaging

ADHESIVE

Cartridges 12 pcs - 300 ml (MS 45) and 290 ml (MS 55)

ART.

| | | | |
|-----------------------|-------|--------------------------|-----------|
| MAPEFLEX MS 45 | white | <input type="checkbox"/> | 6PB010043 |
| MAPEFLEX MS 55 | white | <input type="checkbox"/> | 6PV010043 |

For further information, please see Mapei price list.





profiles for floors of same height

The range of profiles is designed to combine different materials with elegance and simplicity. The coupling of different materials thus becomes interior style and not visual limit.

profiles for floors of same height

cerfix® proangle

Proangle is a line of profiles to finish, protect and decorate floors of same level in ceramic, marble, granite, wood or other material. It is also ideal as separation and decoration joint between floors made of different materials, as finishing and protection element for the edges of steps, platforms and worktops and as perimeter profile for the shaping of doormats. Proangle B in natural aluminium is particularly suitable where it is necessary to proceed to polishing, even deep, of marble, resin and wood surfaces.



AI/10 stainless steel AISI 304 DIN 1.4301

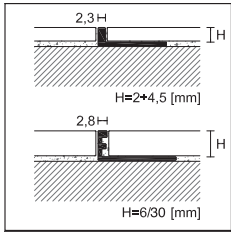

ZG/
ZA/
ZN/
ZK/

PPDESIGN

PROANGLE

length = 270 cm - pack 20 pcs

| | | H | | | | |
|------------------|-------------------|-------|-------|-------|-------|-------|
| ART. | finishing | 2 | 2,5 | 3 | 4,5 | 6 |
| ALUMINIUM | | | | | | |
| ZG/ | natural aluminium | 90207 | 90206 | 90208 | 90210 | 88159 |
| | euro/m | | | | | |
| ZA/ | silver anodised | 90336 | 90337 | 90338 | 90340 | 88204 |
| | euro/m | | | | | |
| BRASS | | | | | | |
| ZN/ | natural brass | - | - | 90078 | 90080 | 88024 |
| | euro/m | - | - | | | |
| ZK/ | chromium plated | - | - | - | 90081 | 88114 |
| | euro/m | - | - | - | | |

individually packed - ZA/ H 10 and ZG/ H 8 - 10 - 12 are available in length of 90 cm euro/m + art. ZN/22,5 pack 5 pcs

PROANGLE

length = 270 cm - pack 20 pcs

| | | H | | | |
|------------------------|---|-------|-------|-------|-------|
| ART. | finishing | 3 | 4,5 | 6 | 8 |
| STAINLESS STEEL | | | | | |
| AI/ | stainless steel AISI 304 DIN 1.4301 | 91636 | 91638 | 91642 | 91644 |
| | euro/m | | | | |
| AIS/ | brushed stainless steel AISI 304 - DIN 1.4301 | - | 91671 | 91673 | 91674 |
| | euro/m | - | | | |
| AIX/ | stainless steel AISI 316 DIN 1.4404 | - | - | 91684 | 91685 |
| | euro/m | - | - | | |

individually packed - AI/ H 10 is available in length of 90 cm euro/m +

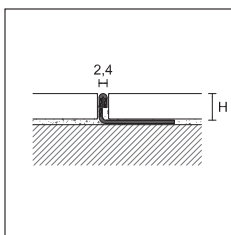

AI/
AIS/
AIX/

Profiles PROANGLE sandblasted stainless steel finish see page 28

Complete the article code with H measure (for example ZG/ for H=10 becomes ZG/10)

Items AIX/ in other heights, on demand for minimum 540 meters for each height



ZG/10 natural aluminium

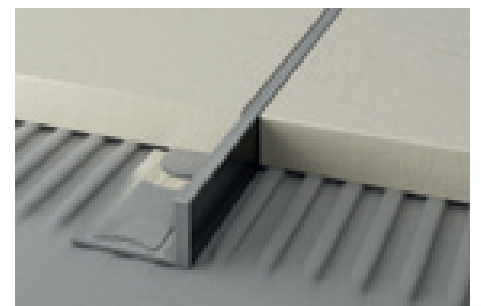

ZBG/10 natural aluminium



ZN/10 natural brass



ZK/10 chromium-plated brass

| H | | | | | | | | | | | | |
|-------|-------|-------|-------|-------|-------|-------|-------|-------|-------|-------|------|----|
| 8 | 9 | 10 | 11 | 12,5 | 14 | 15 | 17,5 | 20 | 22,5 | 25 | 27,5 | 30 |
| 88160 | 88155 | 88161 | 88156 | 88162 | 88157 | 88163 | 88164 | 88165 | 88166 | 88167 | - | - |
| 88205 | 88217 | 88206 | 88218 | 88207 | - | 88208 | 88209 | 88210 | 88211 | 88212 | - | - |
| 88025 | - | 88026 | 88038 | 88027 | - | 88028 | 88029 | 88030 | 88031 | - | - | - |
| 88115 | - | 88116 | 88118 | 88117 | - | - | - | - | - | - | - | - |

| H | | | | | | | | | | | | |
|-------|-------|-------|-------|-------|-------|-------|-------|-------|-------|-------|-------|--|
| 9 | 10 | 11 | 12,5 | 14 | 15 | 17,5 | 20 | 22,5 | 25 | 27,5 | 30 | |
| 91645 | 91646 | 91647 | 91648 | 91649 | 91650 | 91652 | 91654 | 91656 | 91658 | 91660 | 91662 | |
| - | 91675 | 91677 | 91676 | - | 91678 | - | 91679 | - | - | - | - | |
| - | 91686 | 91688 | 91687 | - | - | - | - | - | - | - | - | |

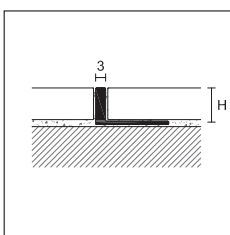

ZBG/



PROANGLE B

length = 270 cm - pack 20 pcs

| | | H | | | | | |
|------------------|-------------------|-------|-------|-------|-------|-------|-------|
| ART. | finishing | 8 | 10 | 12,5 | 15 | 20 | 22,5 |
| ALUMINIUM | | | | | | | |
| ZBG/ | natural aluminium | 90010 | 90012 | 90014 | 90016 | 90018 | 90020 |
| | euro/m | | | | | | |

individually packed

Complete the article code with H measure (for example ZBG/ for H=10 becomes ZBG /10)

proflex line

Proangle is also available in the Flex version, specially studied for those situations where there is the need to curve the profile. Proangle Flex can be curved by hand or through the specific tool Proflex Machine.



AIF/10 stainless steel AISI 304 DIN 14301

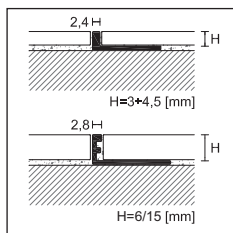

ZGF/
ZNF/

PRO FLEX LINE

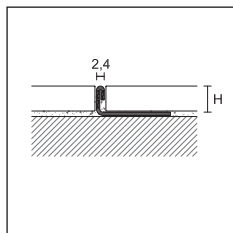

AIF/

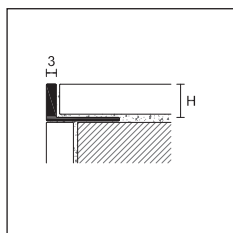

ZBGF/

PRO FLEX LINE

PROANGLE FLEX

length = 270 cm - pack 20 pcs

| | | H | | | | | | | |
|------------------|-------------------|---------------|-------|-------|-------|-------|-------|-------|-------|
| ART. | finishing | 3 | 4,5 | 6 | 8 | 10 | 12,5 | 15 | |
| ALUMINIUM | | | | | | | | | |
| ZGF/ | natural aluminium | | 88720 | 88721 | 88722 | 88723 | 88724 | 88725 | 88726 |
| | | <i>euro/m</i> | | | | | | | |

BRASS

| | | | | | | | | | |
|------|---------------|---------------|-------|---|-------|-------|-------|-------|---|
| ZNF/ | natural brass | | 88701 | - | 88703 | 88704 | 88705 | 88706 | - |
| | | <i>euro/m</i> | | | | | | | |

length = 270 cm - pack 10 pcs

STAINLESS STEEL

| | | | | | | | | | |
|------|---------------------------------------|---------------|---|---|-------|-------|-------|-------|---|
| AIF/ | stainless steel AISI 304 DIN 14301 | | - | - | 91622 | 91623 | 91624 | 91625 | - |
| | | <i>euro/m</i> | | | | | | | |

Proangle Flex is available in other heights on request.

PROANGLE FLEX

length = 270 cm - pack 20 pcs

| | | H | | | | | | |
|------------------|-------------------|---------------|-------|-------|-------|-------|-------|-------|
| ART. | finishing | 8 | 10 | 12,5 | 15 | 20 | 22,5 | |
| ALUMINIUM | | | | | | | | |
| ZBGF/ | natural aluminium | | 90011 | 90013 | 90015 | 90017 | 90019 | 90021 |
| | | <i>euro/m</i> | | | | | | |

individually packed



Complete the article code with H measure (for example ZGF/ for H=8 becomes ZGF/8)

PROFLEX MACHINE - hand machine to bend proflex line profiles, see page 250

Prodecor and Prodecor DJ are two lines of profiles for finishing and protecting floors of same level in ceramic, marble, granite, wood or other materials. They are also ideal as separation and decoration joints between floors made of different materials, as perimeter profiles for the shaping of doormats or as protection and finishing of platforms and ceramic steps.

The visible thickness makes the profile an elegant separation element perfectly integrated into the floor.

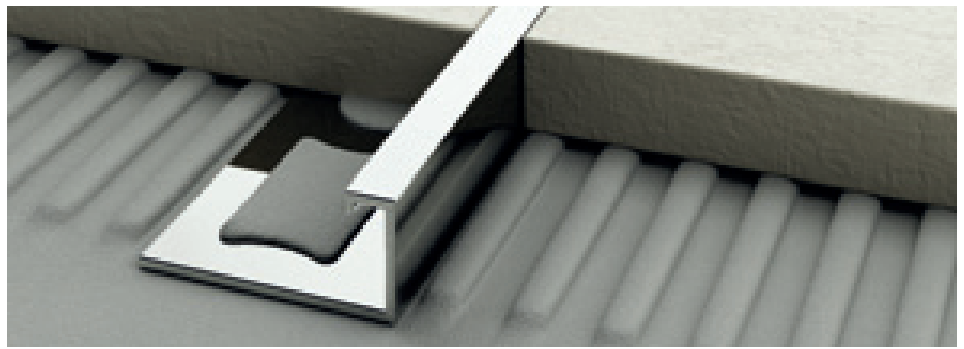

DJK/15 chromium-plated brass

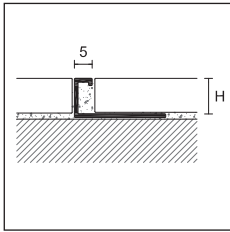

DJG/
DJA/
DJN/
DJK/



PPDESIGN

PRODECOR DJ

length = 270 cm - pack 20 pcs

| | | H | | | | |
|------------------------------|-------------------|---|-------|-------|-------|-------|
| ART. | finishing | 8 | 10 | 12,5 | 15 | 20 |
| ALUMINIUM | | | | | | |
| DJG/ | natural aluminium | | 95670 | 95672 | 95674 | - |
| | <i>euro/m</i> | | | | - | - |
| DJA/ | silver anodised | | 95680 | 95682 | 95684 | - |
| | <i>euro/m</i> | | | | - | - |
| BRASS | | | | | | |
| DJN/ | natural brass | | 95690 | 95692 | 95694 | 95691 |
| | <i>euro/m</i> | | | | | 95693 |
| CHROMIUM-PLATED BRASS | | | | | | |
| DJK/ | chromium plated | | 95700 | 95702 | 95704 | 95703 |
| | <i>euro/m</i> | | | | | 95705 |

individually packed - art. DJN/20 and DJK/20 pack 10 pcs

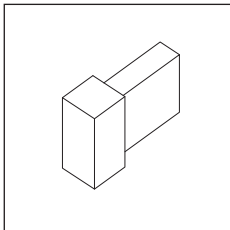

OUTSIDE AND INSIDE CORNERS

pack 5 pcs

| | | H | | | | |
|------------------------------|-------------------|---|-------|-------|-------|-------|
| ART. | finishing | 8 | 10 | 12,5 | 15 | 20 |
| ALUMINIUM | | | | | | |
| DJG/ /EI | natural aluminium | | 95676 | 95677 | 95678 | - |
| | <i>euro/pc</i> | | | | - | - |
| DJA/ /EI | silver anodised | | 95686 | 95687 | 95688 | - |
| | <i>euro/pc</i> | | | | - | - |
| BRASS | | | | | | |
| DJN/ /EI | natural brass | | 95696 | 95697 | 95698 | 95715 |
| | <i>euro/pc</i> | | | | | 95716 |
| CHROMIUM-PLATED BRASS | | | | | | |
| DJK/ /EI | chromium plated | | 95706 | 95707 | 95708 | 95709 |
| | <i>euro/pc</i> | | | | | 95710 |

no partial packaging

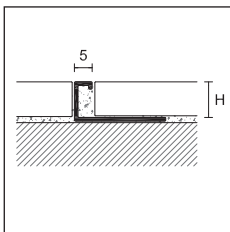

DJAF/
DJNF/



PRO FLEX LINE

PRODECOR DJ FLEX

length = 270 cm - pack 10 pcs

| | | H | | | | |
|------------------|-----------------|---|----|-------|-------|----|
| ART. | finishing | 8 | 10 | 12,5 | 15 | 20 |
| ALUMINIUM | | | | | | |
| DJAF/ | silver anodised | | - | 95685 | 95689 | - |
| | <i>euro/m</i> | | | | - | - |
| BRASS | | | | | | |
| DJNF/ | natural brass | | - | 95695 | 95699 | - |
| | <i>euro/m</i> | | | | - | - |

individually packed

DJAF/ and DJNF/ are available in 8, 15 and 20 mm height on request, with a minimum order of 100 pcs for each code.

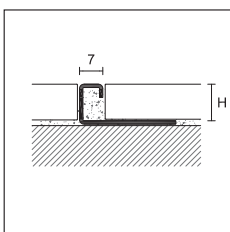

DI/



PRODECOR

length = 270 cm - pack 20 pcs

| | | H | | | | |
|------------------------|---|---|-------|-------|-------|-------|
| ART. | finishing | 8 | 10 | 12,5 | 15 | 20 |
| STAINLESS STEEL | | | | | | |
| DI/ | polished stainless steel AISI 304 DIN 1.4301 | | 95906 | 95908 | 95910 | 95911 |
| | <i>euro/m</i> | | | | | 95907 |

art. DI/20 pack 10 pcs

cerfix® prostyle

Prostyle is a line of multi-purpose profiles for the finishing and decoration of floors of same level in ceramic, marble, granite or other types of materials. It is also ideal as separation and decoration joint between floors of different materials and, in the stainless steel version, it is suitable for the protection of ceramic steps and for the surfaces subject to the passage of heavy and frequent loads.

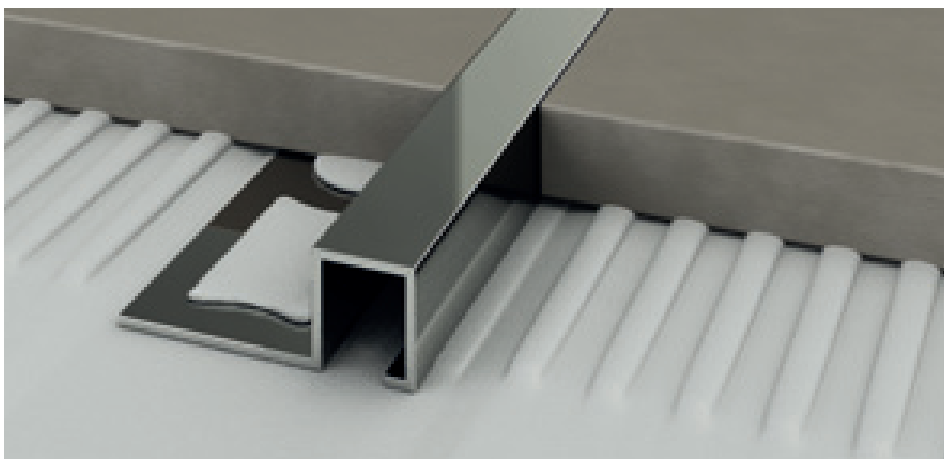

UK/12 chromium-plated brass

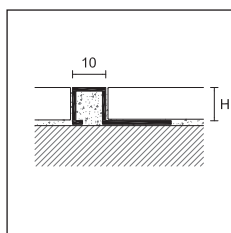

UG/
UA/
UN/
UK/

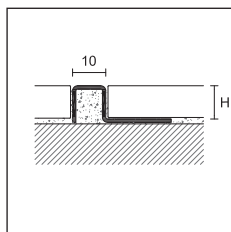

UI/
UIS/

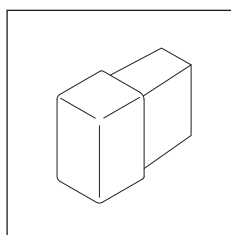

PROSTYLE

length = 270 cm - pack 20 pcs

| | | H | | | | | | |
|------------------|-------------------|---|-------|-------|------|-------|-------|---|
| ART. | finishing | 8 | 10 | 11 | 12,5 | 15 | 20 | |
| ALUMINIUM | | | | | | | | |
| UG/ | natural aluminium | | 93368 | 93370 | - | 93372 | 93377 | - |
| | <i>euro/m</i> | | | - | | | | - |
| UA/ | silver anodised | | 93378 | 93380 | - | 93382 | 93387 | - |
| | <i>euro/m</i> | | | - | | | | - |

length = 270 cm - pack 10 pcs

| | | | | | | | | |
|------------------------|---|--|-------|-------|-------|-------|-------|-------|
| STAINLESS STEEL | | | | | | | | |
| UI/ | polished stainless steel AISI 304 DIN 1.4301 | | 93400 | 93401 | - | 93402 | 93403 | 93404 |
| | <i>euro/m</i> | | | - | | | | |
| UIS/ | brushed stainless steel AISI 304 DIN 1.4301 | | 93348 | 93350 | - | 93352 | 93360 | 93361 |
| | <i>euro/m</i> | | | - | | | | |
| BRASS | | | | | | | | |
| UN/ | natural brass | | 93300 | 93302 | 93311 | 93304 | 93306 | 93308 |
| | <i>euro/m</i> | | | | | | | |
| UK/ | chromium plated | | 93325 | 93327 | 93312 | 93329 | 93338 | 93340 |
| | <i>euro/m</i> | | | | | | | |

individually packed

OUTSIDE AND INSIDE CORNERS

pack 5 pcs

| | | H | | | | | | |
|------------------------|---|---|-------|-------|-------|-------|-------|-------|
| ART. | finishing | 8 | 10 | 11 | 12,5 | 15 | 20 | |
| ALUMINIUM | | | | | | | | |
| UG/ /EI | natural aluminium | | 93373 | 93374 | - | 93375 | 93376 | - |
| | <i>euro/pc</i> | | | - | | | | - |
| UA/ /EI | silver anodised | | 93383 | 93384 | - | 93385 | 93386 | - |
| | <i>euro/pc</i> | | | - | | | | - |
| STAINLESS STEEL | | | | | | | | |
| UI/ /EI | polished stainless steel AISI 304 DIN 1.4301 | | 93405 | 93406 | - | 93407 | 93408 | 93409 |
| | <i>euro/pc</i> | | | - | | | | |
| UIS/ /EI | brushed stainless steel AISI 304 DIN 1.4301 | | 93353 | 93354 | - | 93355 | 93356 | 93357 |
| | <i>euro/pc</i> | | | - | | | | |
| BRASS | | | | | | | | |
| UN/ /EI | natural brass | | 93301 | 93303 | 93341 | 93305 | 93307 | 93309 |
| | <i>euro/pc</i> | | | | | | | |
| UK/ /EI | chromium plated | | 93334 | 93335 | 93342 | 93336 | 93337 | 93339 |
| | <i>euro/pc</i> | | | | | | | |

no partial packaging

Complete the article code with H measure
(for example UG/ for H=8 becomes UG/8)

Projoint U and Projoint they are a range of separation joints in stainless steel and brass, especially suitable in case of transit of high and frequent loads. The version 799 / in case of need can be inserted and polished even after the installation after the cutting of the flooring.

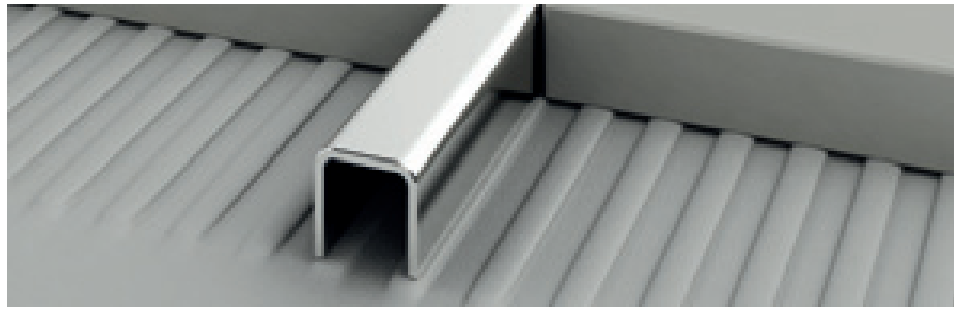

799/U/12 polished stainless steel AISI 304 DIN 1.4301

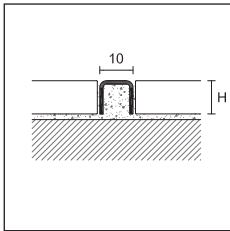

799/U/
399/U



PROJOINT U

length = 270 cm - pack 20 pcs

| | | |
|----------|-----------|-------------|
| H | 10 | 12,5 |
|----------|-----------|-------------|

ART. finishing

STAINLESS STEEL

| | | | | |
|---------------|---|---|-------|-------|
| 799/U/ | polished stainless steel AISI 304 DIN 1.4301 |  | 75078 | 75072 |
| | <i>euro/m</i> | | | |

BRASS

| | | | | |
|--------------|----------------|---|-------|---|
| 399/U | polished brass |  | 75077 | - |
| | <i>euro/m</i> | | | - |

individually packed

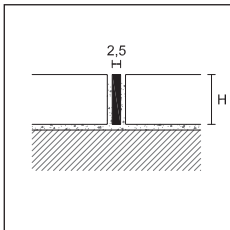

799/



PROJOINT

length = 270 cm - pack 20 pcs

| | |
|----------|-----------|
| H | 10 |
|----------|-----------|

ART. finishing

STAINLESS STEEL

| | | | |
|-------------|--|---|-------|
| 799/ | stainless steel AISI 304 DIN 1.4301 |  | 74966 |
| | <i>euro/m</i> | | |

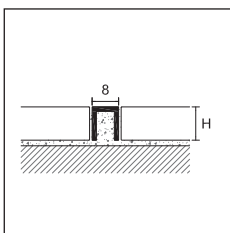

380/8

PROJOINT

length = 270 cm - pack 20 pcs

| | |
|---------------------|-------------|
| measures LxH | 8x10 |
|---------------------|-------------|

ART. finishing

BRASS

| | | | |
|--------------|---------------|---|-------|
| 380/8 | natural brass |  | 75047 |
| | <i>euro/m</i> | | |

Complete the article code with H measure
(for example 799/U/ for H=10 becomes 799/U/10)

projoint

Projoint T is a line of profiles for the separation, protection and decoration of same-level floors in ceramic, marble, granite, wood or other materials. It is also ideal to cover any imperfections due to the cutting or for the laying of floors made of different materials. Its special section allows to cover slight height differences (2÷3 mm) between two different types of floor. It is also easy to install, thanks to the arrow shape which allows a perfect fixing with sealants or adhesives.



99/T/14 silver anodised aluminium

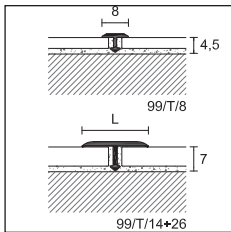

99/T/
399/T/
399/TC/



PROJOINT T

| | | | | |
|------------------------|----------|-----------|-----------|-----------|
| length = 270 cm - pack | 50 pcs | 50 pcs | 30 pcs | 20 pcs |
| width | 8 | 14 | 20 | 26 |

ART. finishing

ALUMINIUM

| | | | | | |
|--|--|-------|-----------|-------|-------|
| silver anodised | | 75075 | 75080 | 63600 | 75082 |
| euro/m | | | | | |
| gold anodised | | - | 75083 | 75084 | 75085 |
| euro/m | | | | | |
| 99/T/ titanium anodised | | - | 75099 | - | - |
| euro/m | | | | | |
| colour-coated anthracite grey RAL 7016 | | - | 75091 | - | - |
| euro/m | | | | | |
| length = 270 cm - pack | | - | 10 pcs | - | - |
| width | | - | 14 | - | - |

ART. finishing

ALUMINIUM decors ALCROM® PLUS

| | | | | | |
|----------------|--|---|-------|---|---|
| 99/T/ 97 black | | - | 75095 | - | - |
| euro/m | | | | | |

individually packed

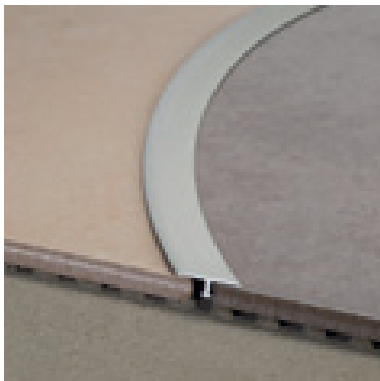

99/T/14 silver anodised aluminium

PROJOINT T

| | | |
|--|--|-----------|
| length = 90 cm - pack 10 pcs / blister | | L |
| ART. finishing | | 14 |

ALUMINIUM

| | | |
|----------------------|--|-------|
| silver anodised | | 20008 |
| euro/pc | | |
| 499/T/ gold anodised | | 20010 |
| euro/pc | | |

PROJOINT T

| | |
|-------------------------------|-----------------|
| length = 270 cm - pack 20 pcs | LxH |
| ART. finishing | 26 X 4,5 |

ALUMINIUM

| | | |
|--------------------------|--|-------|
| 99/TR/26 silver anodised | | 75081 |
| euro/m | | |

individually packed

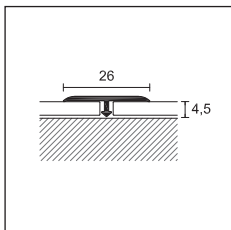

99/TR/26

PRO FLEX LINE

Projoint T 99/T/ can be bent with Proflex Machine (except 99/T/14 97 black).

Complete the article code with L measure (for example 99/T/ for L=14 becomes 99/T/14)

packaging in blister no partial packaging

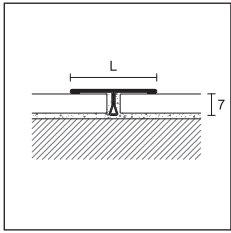

799/T/
799/TS/

PROJOINT T

| | | |
|------------------------|-----------|-----------|
| length = 270 cm - pack | 30 pcs | 20 pcs |
| width | 14 | 26 |

ART. finishing

STAINLESS STEEL

| | | | | |
|----------------|---|--|-------|-------|
| 799/T/ | polished stainless steel AISI 304 DIN 1.4301 | | 75092 | 75096 |
| 799/TS/ | brushed stainless steel AISI 304 DIN 1.4301 | | 75093 | 75097 |

individually packed

PROJOINT T

| | | |
|--|--|----------|
| length = 90 cm - pack 10 pcs / blister | | L |
|--|--|----------|

| | |
|-----------------------|-----------|
| ART. finishing | 14 |
|-----------------------|-----------|

| | | | | |
|----------------|---|--|-------|---|
| 4799/T | polished stainless steel AISI 304 DIN 1.4301 | | 20001 | - |
| 4799/TS | brushed stainless steel AISI 304 DIN 1.4301 | | 20002 | - |

PROJOINT T

| | | | | |
|------------------------|----------|-----------|-----------|-----------|
| length = 270 cm - pack | 50 pcs | 20 pcs | 20 pcs | 20 pcs |
| width | 8 | 14 | 20 | 26 |

ART. finishing

BRASS

| | | | | | | |
|----------------|-----------------|--|--------|--------|-------|--------|
| 399/T/ | polished | | 75070 | 75087 | 75090 | 75088 |
| | euro/m | | | | | |
| | pack | | 30 pcs | 30 pcs | - | 10 pcs |
| 399/TC/ | chromium plated | | 75071 | 75086 | - | 75089 |
| | euro/m | | | | | |

individually packed

PROJOINT T

| | | |
|--|--|----------|
| length = 90 cm - pack 10 pcs / blister | | L |
|--|--|----------|

| | |
|-----------------------|-----------|
| ART. finishing | 14 |
|-----------------------|-----------|

| | | | |
|---------------|----------------|--|-------|
| 4399/T | polished | | 20016 |
| | euro/pc | | |

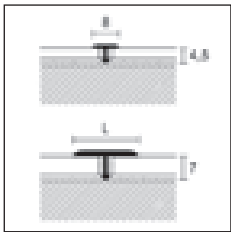

PPDESIGN

399/T/
399/TC/



799/T/26 polished stainless steel AISI 304 DIN 1.4301



399/T/14 polished brass

PRO FLEX LINE

Projoint T 399/T/ and 399/TC/ can be bent with Proflex Machine.

Complete the article code with L measure (for example 799/T/ for L=14 becomes 799/T/14)

projoint

Projoint R is a line of profiles for subdivision and / or decoration of floors of the same level in ceramic, marble, granite, wood or other materials. The thickness of the upper part makes it particularly suitable for the polishing of wood, marble, etc...



399/R/10 natural brass

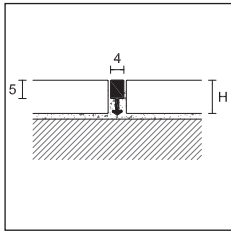

99/R/
399/R/



PROJOINT R

| length = 270 cm - pack 50 pcs | | H | |
|-------------------------------|-------------------|----|-------|
| ART. | finishing | 10 | 14 |
| ALUMINIUM | | | |
| 99/R/ | natural aluminium | | 75006 |
| | <i>euro/m</i> | | 75016 |
| length = 270 cm - pack 20 pcs | | H | |
| BRASS | | | |
| 399/R/ | natural brass | | 75007 |
| | <i>euro/m</i> | | 75017 |
| length = 90 cm - pack 10 pcs | | | |
| BRASS | | | |
| 4399/R/10 | natural brass | | 20006 |
| | <i>euro/pc</i> | | - |

Projoint M is ideal as a separation joint and / or renovation and decoration between floors of the same level laid with glue or mortar. Used between materials of different thickness or type, it could also be polished both in the aluminium and brass version.



399/M natural brass

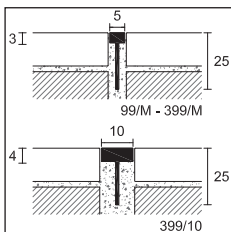

99/M
399/M
399/10



PROJOINT M

| length = 270 cm - pack | | 50 pcs | |
|------------------------|-------------------|--------|---------|
| measures | | 5x3x25 | 10x4x25 |
| ART. | finishing | | |
| ALUMINIUM | | | |
| 99/M | natural aluminium | | 75005 |
| | <i>euro/m</i> | | - |
| | <i>euro/m</i> | | - |
| | pack | | 20 pcs |
| | | | 10 pcs |
| BRASS | | | |
| 399/M | natural brass | | 74975 |
| | <i>euro/m</i> | | - |
| | <i>euro/m</i> | | - |
| 399/10 | natural brass | | - |
| | <i>euro/m</i> | | 74906 |
| | <i>euro/m</i> | | - |

Complete the article code with H measure (for example 99/R/ for H=10 becomes 99/R/10)

packaging in blister no partial packaging

Proclassic R is a line of profiles specially designed as threshold cover and to hide junctions and possible imperfections due to the cutting or the laying between floors of different materials. The rounded shape allows to compensate a slight height difference 2÷3 mm) between two different types of floor. The fixing is particularly easy thanks to the possibility to use adhesive or screws.

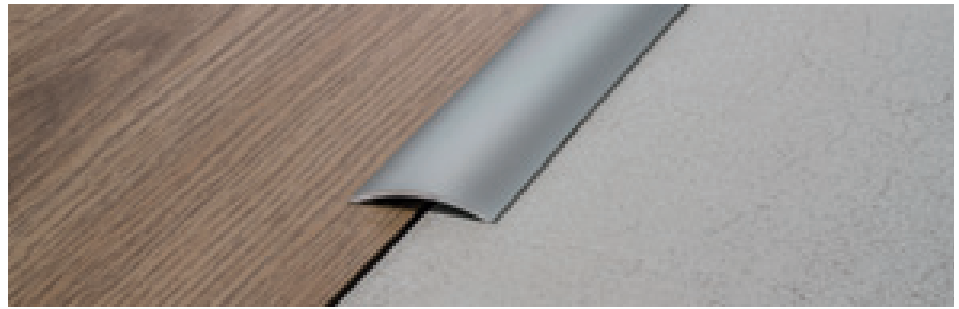

30/A silver anodised aluminium

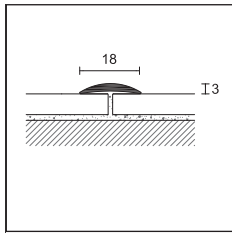

21/

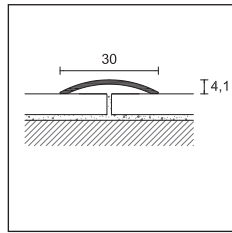

30/



PROCLASSIC R

length = 270 cm - pack 20 pcs

| | | |
|------------------|------------------|----------|
| ART. | finishing | A |
| ALUMINIUM | | |
| 21/ | silver anodised | 71037 |
| | euro/m | |
| | gold anodised | 71047 |
| | euro/m | |

individually packed

PROCLASSIC R

| | | | | | | | | | | | |
|--|----------|----------|------------------|-----------|-----------|-----------|-----------|-----------|-----------|-----------|-------|
| pack | 30 pcs | | 10 pcs / blister | | | | | | | | |
| length cm | 270 | | 83 | 93 | 103 | 166 | | | | | |
| ART. | 30/ | | 430/ | | | | | | | | |
| finishing | F | A | CV | AD | CV | AD | CV | AD | CV | AD | |
| ALUMINIUM | | | | | | | | | | | |
| silver anodised | | 71067 | 71097 | 20128 | 20148 | 20132 | 20152 | - | 20156 | 20140 | 20160 |
| gold anodised | | 71077 | 71107 | - | - | 20133 | 20153 | - | 20157 | - | 20161 |
| euro/m | | | | | | | | | | | |
| euro/pc | | | | | | | | | | | |
| titanium anodised | | - | 71098 | - | - | - | - | - | - | - | - |
| euro/m | | | | | | | | | | | |
| euro/pc | | | | | | | | | | | |
| bronze anodised | | - | 71117 | - | - | - | 20154 | - | - | - | - |
| euro/m | | | | | | | | | | | |
| euro/pc | | | | | | | | | | | |
| colour-coated anthracite grey RAL 7016 | | - | 71101 | - | - | - | - | - | - | - | - |
| euro/m | | | | | | | | | | | |

individually packed

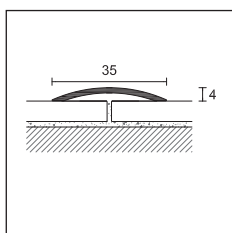

35/

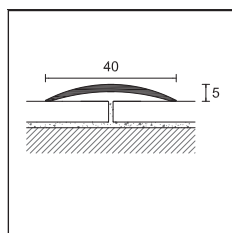

41/

PROCLASSIC R

length = 270 cm - pack 20 pcs

| | | |
|------------------|----------|----------|
| ART. | 35/ | |
| finishing | F | A |
| ALUMINIUM | | |
| silver anodised | | 71387 |
| euro/m | | 71417 |

individually packed

PROCLASSIC R

| | | | |
|-------------------|----------|----------|------------------|
| pack | 20 pcs | | 10 pcs / blister |
| length cm | 270 | | 90 |
| ART. | 41/ | | 441/ |
| finishing | F | A | AD |
| ALUMINIUM | | | |
| silver anodised | | 71587 | 71617 |
| euro/m | | | 20552 |
| euro/pc | | | - |
| gold anodised | | - | 71627 |
| titanium anodised | | - | 71618 |
| euro/m | | | 20553 |
| euro/pc | | | 20555 |
| bronze anodised | | - | 71637 |
| euro/m | | | - |
| euro/pc | | | - |

individually packed

Complete the article code with F= drilled, A-A-D=adhesive, CV=with screws (for example 30/ becomes 30/F)

packaging in blister no partial packaging

proclassic

Proclassic R in stainless steel is particularly suitable in public spaces and in the case of passage of frequent and heavy loads. The sparkle of polished stainless steel also matches perfectly the modern floors and furnishings.

Proclassic R in polished brass is classic and modern at the same time and can be easily combined to handles, taps and other furniture accessories of the same material and finish.



720/A polished stainless steel AISI 430 DIN 1.4016

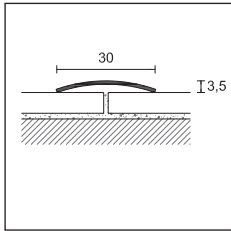

720/
722/
020/

PROCLASSIC R

| | | | | | | | | | |
|---|-------------|-------------|-------------|-------------|-----|-----|-----|-------|--|
| pack | 20 pcs | PRO | | | | | | | |
| length cm | 270 | 73 | 83 | 93 | 103 | 166 | | | |
| ART. | 720/ | 720/ | | | | | | | |
| finishing | F A | F A | F A | F A | F A | F A | F A | F A | |
| STAINLESS STEEL (thickness 10/10) | | | | | | | | | |
| polished stainless steel AISI 430 - DIN 1.4016 | 71287 71297 | 71280 71290 | 71281 71291 | 71282 71292 | - | - | - | 71294 | |
| euro/m | - | - | - | - | - | - | - | - | |
| euro/pc | - | - | - | - | - | - | - | - | |

| | | | | | | | | | |
|---|---------|-------------|-------------|-------------|-------------|-------------|-------|-------|-------|
| 10 pcs / blister | | | | | | | | | |
| ART. | 4720/ | | | | | | | | |
| finishing | | CV AD | CV AD | CV AD | CV AD | CV AD | CV AD | CV AD | CV AD |
| polished stainless steel AISI 430 - DIN 1.4016 | - - | 20287 20293 | 20288 20294 | 20289 20295 | 20290 20296 | 20291 20297 | | | |
| euro/pc | - - | - | - | - | - | - | - | - | - |
| brushed stainless steel AISI 430 - DIN 1.4016 | - 71298 | - - | - - | - - | - - | - - | - - | - - | |
| euro/m | - | - | - | - | - | - | - | - | |

individually packed

PROCLASSIC R

| | | | | | | | | | |
|--|---------|------------------|-------|---------|-------|-------|-------|-------|--|
| pack | 20 pcs | 10 pcs / blister | | | | | | | |
| length cm | 270 | 73 | 83 | 93 | 103 | 166 | | | |
| ART. | 722/ | 4722/ | | | | | | | |
| finishing | - A | CV AD | CV AD | CV AD | CV AD | CV AD | CV AD | CV AD | |
| STAINLESS STEEL (thickness 10/10) | | | | | | | | | |
| brushed stainless steel AISI 304 - DIN 1.4301 | - 71268 | - - | - - | - 20300 | - - | - - | - - | - - | |
| euro/m | - | - | - | - | - | - | - | - | |
| euro/pc | - | - | - | - | - | - | - | - | |

individually packed

PROCLASSIC R

| | | | | | | | | | |
|--------------------------------|-------------|------------------|-------------|-------------|-------------|-------------|-------|-------|--|
| pack | 20 pcs | 10 pcs / blister | | | | | | | |
| length cm | 270 | 73 | 83 | 93 | 103 | 166 | | | |
| ART. | 020/ | 4020/ | | | | | | | |
| finishing | F A | CV AD | CV AD | CV AD | CV AD | CV AD | CV AD | CV AD | |
| BRASS (thickness 10/10) | | | | | | | | | |
| polished | 71187 71207 | 20207 20213 | 20208 20214 | 20209 20215 | 20210 20216 | 20211 20217 | | | |
| euro/m | - | - | - | - | - | - | - | - | |
| euro/pc | - | - | - | - | - | - | - | - | |

individually packed



020/A polished brass

Complete the article code with F= drilled, A=adhesive, CV=with screws (for example 720/ drilled becomes 720/F)

packaging in blister no partial packaging

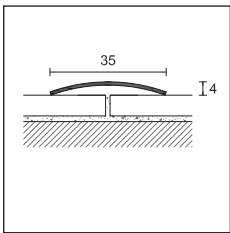

726/



PROCLASSIC R

| | | | | | | | |
|-----------|--------|------|-----|-----|-----|-----|--|
| pack | 20 pcs | PRO | | | | | |
| length | 270 | 83 | 93 | 166 | | | |
| ART. | 726/ | 726/ | | | | | |
| finishing | F A | F A | F A | F A | F A | F A | |

STAINLESS STEEL (thickness 10/10)

| | | | | | | | | | |
|---|--|-------|-------|---|---|-------|-------|---|---|
| polished stainless steel AISI 430 - DIN 1.4016 | | 71507 | 71517 | - | - | 71502 | 71512 | - | - |
| euro/m | | - | - | - | - | - | - | - | - |
| euro/pc | | - | - | - | - | - | - | - | - |

10 pcs / blister

| | | | | | | | |
|---|-------|----|-------|-------|-------|----|-------|
| ART. | 4726/ | | | | | | |
| finishing | | CV | AD | CV | AD | CV | AD |
| polished stainless steel AISI 430 - DIN 1.4016 | | - | 26016 | 26010 | 26017 | - | 26019 |
| euro/pc | | - | - | - | - | - | - |

| | | | | | | | |
|--|--|---|-------|---|---|---|---|
| brushed stainless steel AISI 430 - DIN 1.4016 | | - | 71518 | - | - | - | - |
| euro/m | | - | - | - | - | - | - |

individually packed

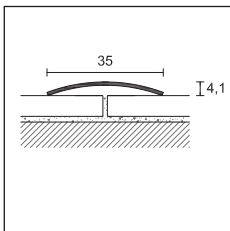

026/

PROCLASSIC R

| | | |
|-----------|--------|------------------|
| pack | 20 pcs | 10 pcs / blister |
| length cm | 270 | 93 |
| ART. | 026/ | 4026/ |
| finishing | F A | CV AD |

BRASS (thickness 10/10)

| | | | | | |
|----------|--|-------|-------|-------|-------|
| polished | | 71447 | 71457 | 20409 | 20415 |
| euro/m | | - | - | - | - |
| euro/pc | | - | - | - | - |

individually packed

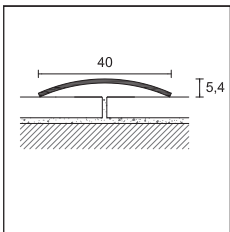

729/

PROCLASSIC R

| | | |
|-----------|--------|-----------------|
| pack | 20 pcs | 5 pcs / blister |
| length | 270 | 93 |
| ART. | 729/ | 4729/ |
| finishing | F A | CV AD |

STAINLESS STEEL (thickness 12/10)

| | | | | | |
|---|--|-------|-------|---|-------|
| polished stainless steel AISI 430 - DIN 1.4016 | | 71667 | 71677 | - | 40220 |
| euro/m | | - | - | - | - |
| euro/pc | | - | - | - | - |
| brushed stainless steel AISI 430 - DIN 1.4016 | | - | 71678 | - | - |
| euro/m | | - | - | - | - |

individually packed



722/A brushed stainless steel AISI 304 DIN 1.4301

Complete the article code with F= drilled, A-A-D=adhesive, CV=with screws (for example 726/ drilled becomes 726/F)

packaging in blister no partial packaging

proclassic

Proclassic F is a line of threshold cover profiles F with a thickness that allows the application under the doors. 19/ and 25/ are provided with a useful non-slip knurled surface. The installation is particularly simple, thanks to the possibility to use adhesive or screws.



25/A silver anodised aluminium

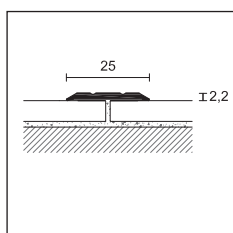

19/



PROCLASSIC F

| | | | | | |
|------------------|--------|-------|------------------|-------|-------|
| pack | 30 pcs | | 10 pcs / blister | | |
| length cm | 270 | | 93 | | |
| ART. | 19/ | | 419/ | | |
| finishing | F | A | CV | AD | |
| ALUMINIUM | | | | | |
| silver anodised | | 71867 | 71897 | 27074 | 27092 |
| euro/m | | | | - | - |
| euro/pc | | - | - | | |
| gold anodised | | - | 71907 | - | 27099 |
| euro/m | | - | | - | - |
| euro/pc | | - | - | - | |

individually packed

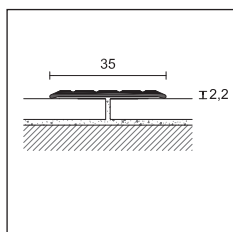

25/

PROCLASSIC F

| | | | | | | |
|------------------|--------|-------|-------|------------------|-------|-------|
| pack | 20 pcs | | | 10 pcs / blister | | |
| length cm | 270 | | | 93 | | |
| ART. | 25/ | | | 425/ | | |
| finishing | F | D | A | CV | AD | |
| ALUMINIUM | | | | | | |
| silver anodised | | 71947 | 71948 | 71977 | 22533 | 22553 |
| euro/m | | | | | - | - |
| euro/pc | | - | - | - | | |
| gold anodised | | 71957 | - | 71987 | 22534 | 22554 |
| euro/m | | - | | | - | - |
| euro/pc | | - | - | - | | |
| bronze anodised | | - | - | 71997 | - | 22555 |
| euro/m | | - | | | - | - |
| euro/pc | | - | - | - | - | |

individually packed

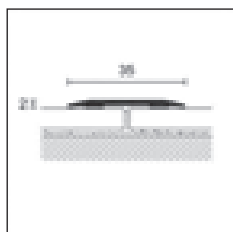

22/A
422/AD

PROCLASSIC F

| | | | | |
|--|--------|-------|------------------|--|
| pack | 10 pcs | | 10 pcs / blister | |
| length cm | 270 | | 90 | |
| ART. | 22/A | | 422/AD | |
| finishing | | | | |
| ALUMINIUM | | | | |
| silver | | 44000 | 43790 | |
| euro/m | | | - | |
| euro/pc | | - | | |
| titanium | | 44001 | 43791 | |
| euro/m | | | - | |
| euro/pc | | - | | |
| ALUMINIUM - decors ALCROM® PLUS | | | | |
| black 97 | | 43996 | - | |
| euro/m | | | - | |
| euro/pc | | - | - | |

Complete the article code with F=drilled, A/AD=adhesive, CV=with screws (for example 19/F drilled becomes 19/F)

packaging in blister no partial packaging

Wood-effect decors available on page 178 and 179

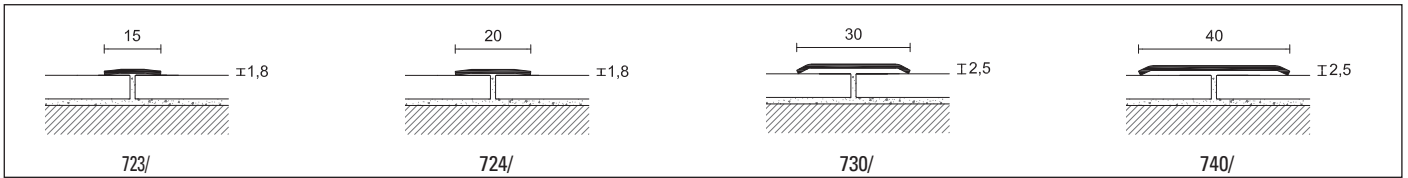

PROCLASSIC F

| | | | | | |
|--------------|--------|--------|--------|--|---------------------------|
| pack | 20 pcs | | | 10 pcs / blister  | 10 pcs |
| length cm | 270 | | | 90 | 270 |
| measures LxH | 15x1,8 | 20x1,8 | 30x2,5 | 30x2,5 | 40x2,5 thickness 10/10 |
| ART. | 723/A | 724/A | 730/A | 4730/AD | 740/A |

STAINLESS STEEL

| | | | | | |
|---|-------|-------|-------|-------|-------|
| polished stainless steel AISI 430 - DIN 1.4016  | 71717 | 71777 | 72117 | 20692 | 72377 |
| euro/m | | | | - | |
| euro/pc | - | - | - | | - |

art. 723/ no individually packed - art. 730/ and 740/ individually packed

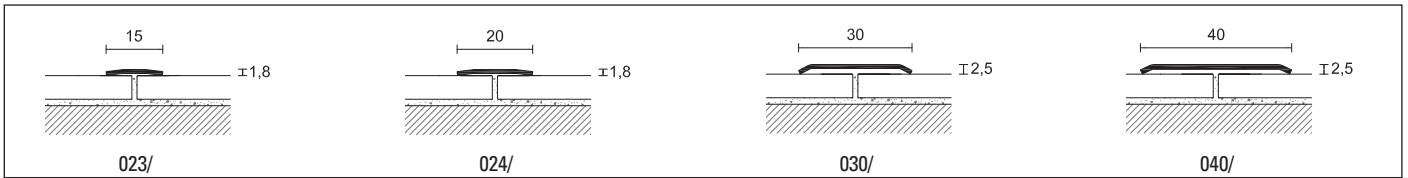

PROCLASSIC F

| | | | | | |
|-----------------------------|--------|--------|--------|--|--------|
| pack | 20 pcs | | | 10 pcs / blister  | 10 pcs |
| thickness 10/10 - length cm | 270 | | | 90 | 270 |
| measures LxH | 15x1,8 | 20x1,8 | 30x2,5 | 30x2,5 | 40x2,5 |
| ART. | 023/A | 024/A | 030/A | 4030/AD | 040/A |

BRASS

| | | | | | |
|--|-------|-------|-------|-------|-------|
| polished  | 71697 | 71757 | 72057 | 20612 | 72317 |
| euro/m | | | | - | |
| euro/pc | - | - | - | | - |

art. 030/ and 040/ individually packed - art. 023/ and 024/ not individually packed



 packaging in blister no partial packaging

22/A aluminium covered with Alcrom® Plus black 97





profiles for floors of different height

The range of profiles for floors of different height is made with a sloping section and allows to connect floors with different thicknesses. Products made of stainless steel, brass or aluminium, are chosen according to the target environment.

Pronivel NZS / is a line of connection between floors of different level composed by a bearing profile and two connection wings of different size. Together the two pieces allow the elimination of the step between floors of different thickness. The articulated connector permits many combinations and the laying of a new flooring on the side of the connector, even after the application of NZS /.

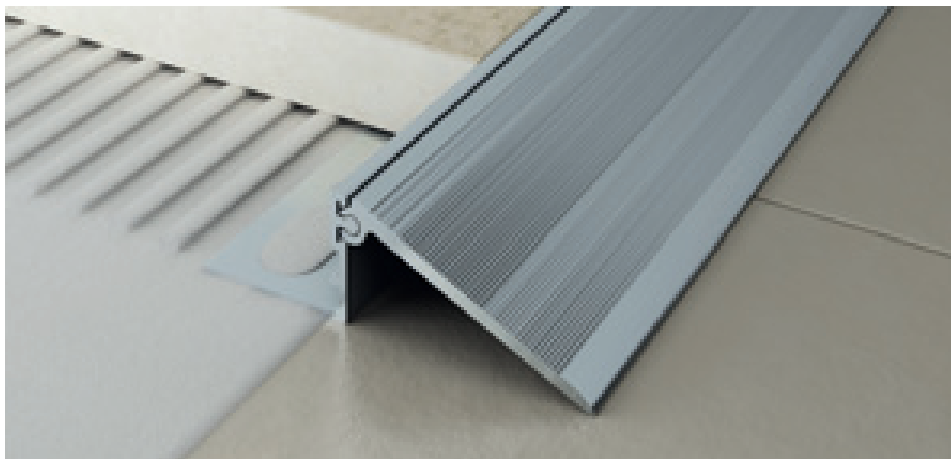

NZS/B/12 + NZS/S2 silver anodised aluminium

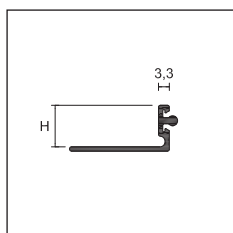

NZS/B/



PRONIVEL N

length = 270 cm - pack 10 pcs

| | | H | | | |
|------------------|----------------------------|-----------|-----------|-------|-------|
| ART. | finishing | 10 | 12,5 | 15 | 20 |
| ALUMINIUM | | | | | |
| NZS/B/ | silver anodised | 99905 | 99906 | 99907 | 99908 |
| | | L | | | |
| | | 38 | 50 | | |
| NZS/S1 | connection silver anodised | 99900 | - | | |
| NZS/S2 | connection silver anodised | - | 99901 | | |

individually packed

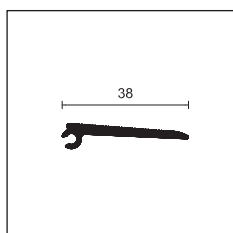

NZS/S1

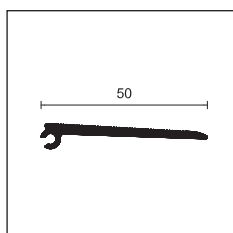

NZS/S2

| | art. NZS/S1 | art. NZS/S2 |
|-------------------------|----------------------------|----------------------------|
| 10 art. NZS/B/10 | 38,5 → +7 0 → -15 | 51 → +5 0 → -25 |
| 12,5 art. NZS/B/12,5 | 38 → +10 0 → -12 | 50,5 → +5 0 → -23 |
| 15 art. NZS/B/15 | 37 → +10 0 → -10 | 50 → +6 0 → -21 |
| 20 art. NZS/B/20 | 35 → +18 0 → -5 | 48 → +15 0 → -15 |

Complete the article code with H measure (eg. NZS/B/ for H=10 becomes NZS/B/10)

Pronivel P is a line of profiles to be applied during the laying of ceramic or marble flooring and suitable for connect different thicknesses. The versions in stainless steel and brass are suitable to withstand heavy stress.

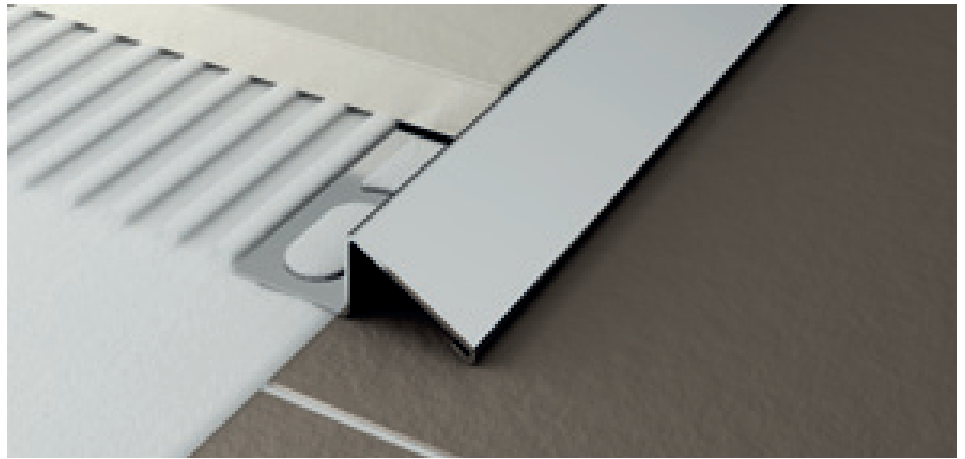

PNI/10 polished stainless steel AISI 304 DIN 1.4301

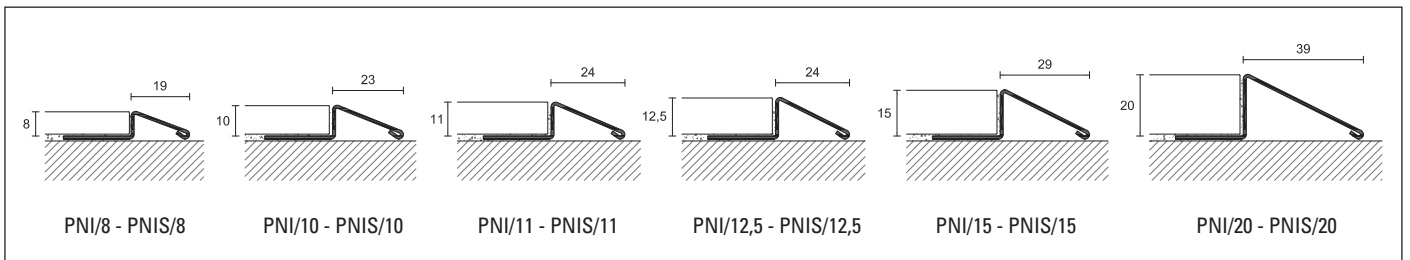
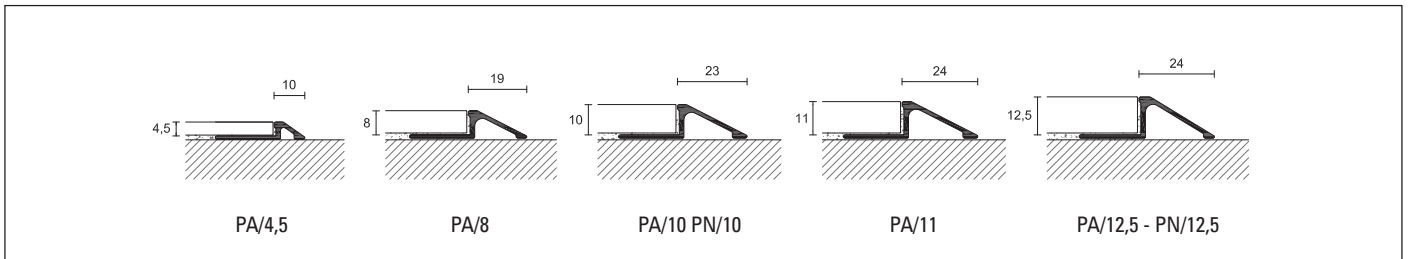

PRONIVEL P

length = 270 cm - pack 10 pcs

| | | H | | | | | | | |
|------------------------|---|-----|-------|-------|-------|-------|-------|-------|-------|
| ART. | finishing | 4,5 | 8 | 10 | 11 | 12,5 | 15 | 20 | |
| ALUMINIUM | | | | | | | | | |
| PA/ | silver anodised | | 93175 | 93181 | 93182 | 93185 | 93183 | - | - |
| | <i>euro/m</i> | | | | | | | - | - |
| STAINLESS STEEL | | | | | | | | | |
| PNI/ | polished stainless steel AISI 304 DIN 1.4301 | | - | 93092 | 93094 | 93090 | 93096 | 93098 | 93100 |
| | <i>euro/m</i> | | - | | | | | | |
| PNIS/ | brushed stainless steel AISI 304 DIN 1.4301 | | - | 93093 | 93095 | 93091 | 93097 | 93099 | 93101 |
| | <i>euro/m</i> | | - | | | | | | |
| BRASS | | | | | | | | | |
| PN/ | natural brass | | - | - | 93122 | - | 93123 | - | - |
| | <i>euro/m</i> | | - | - | | - | | - | - |

individually packed

Complete the article code with H measure (eg. PA/ for H=8 becomes PA/8)

profiles for floors of different height

cerfix® pronivel

Pronivel L is a profile suitable to connect floors of different heights. Applicable on flooring already laid, it is fixed to the floor with adhesive.



45/SF silver anodised aluminium

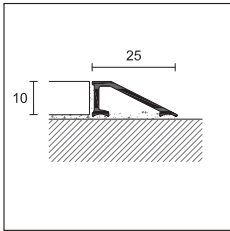

45/



PRONIVEL L

length = 270 cm - pack 20 pcs

ART. finishing

H

10

SF

A

ALUMINIUM

45/ silver anodised



73550

73552

euro/m

individually packed

Pronivel PB is a transition profile between two floors subject to stress. The slight slope makes easier the passing of trolleys or wheelchairs.

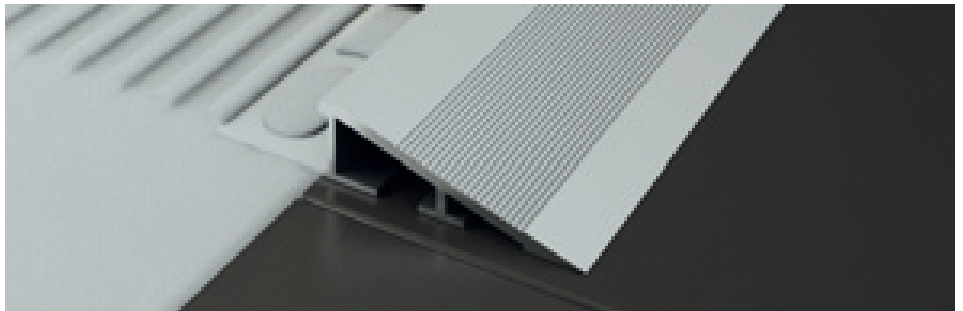

PBA/10 silver anodised aluminium

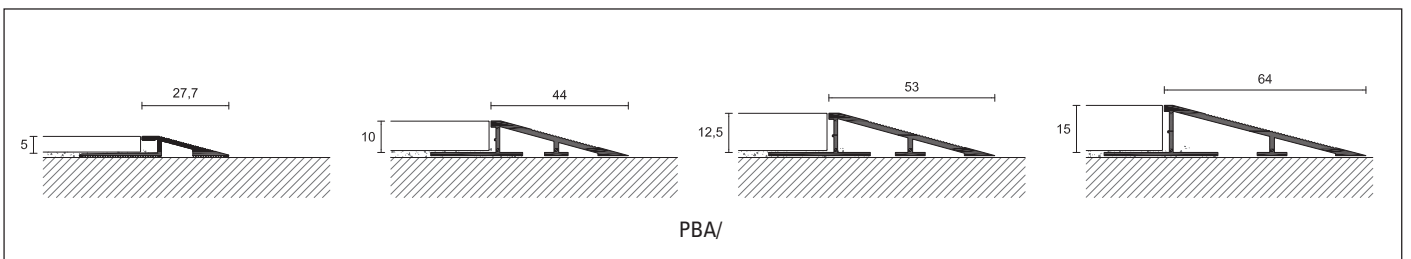

PBA/



PRONIVEL PB

length = 270 cm - pack 10 pcs

ART. finishing

5

10

12,5

15

H

ALUMINIUM

PBA/ silver anodised



93204

93206

93208

93210

euro/m

individually packed

Complete the article code with SF=undrilled, A=adhesive, (eg. 45/ adhesive becomes 45/A)

Complete the article code with H measure (eg. PBA/ for H=10 becomes PBA/10)

Pronivel PL is a line of profiles to be applied during the installation of ceramic or glued wood floors and is suitable for connecting floor coverings of different thicknesses.



PLA/10 silver anodised aluminium

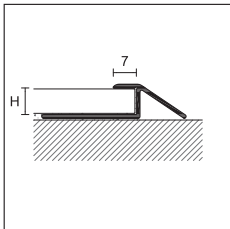

PLA/



NEW PRONIVEL PL

length = 270 cm - pack 10 pcs

| | | H | |
|------------------|-----------------|-------|-------|
| ART. | finishing | 8 | 10 |
| ALUMINIUM | | | |
| PLA/ | silver anodised | 93191 | 93193 |
| <i>euro/m</i> | | | |

individually packed

Pronivel M is a line of profiles designed to connect during installation floors of different heights. The special section is effective in case of connection with carpet or glue-down or loose-lay LVT.



MIN/10 polished stainless steel AISI 304 DIN 1.4301

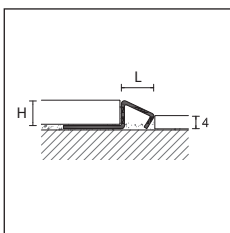

MIN/



PRONIVEL M

length = 270 cm - pack 10 pcs

| | | H | |
|------------------------|--|-------|-------|
| ART. | finishing | 8 | 10 |
| STAINLESS STEEL | | | |
| MIN/ | polished stainless steel AISI 304 DIN 1.4301 | 93023 | 93024 |
| <i>euro/m</i> | | | |

individually packed

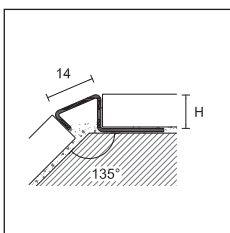

MIN/

Complete the article code with H measure (for example PLA/ for H=8 becomes PLA/8)

Complete the article code with H measure (for example MIN/ for H=10 becomes MIN/10)

prolevel

Prolevel 61/ is a line of profiles to be applied after the installation, and can compensate for differences in height between 6.5 and 13 mm.



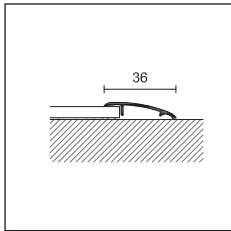

61/A silver anodised aluminium



61/



PROLEVEL HIGH

| | | | |
|------------------|---|------------------|---|
| pack | 20 pcs | 10 pcs / blister |  |
| length cm | 270 | 90 | |
| ART. | 61/ | 461/ | |
| finishing | A | AD | |
| ALUMINIUM | | | |
| silver anodised |  73437 | 21200 | |
| euro/m | | - | |
| euro/pc | | - | |

art. 61/ individually packed

Prolevel High 55/ and 57/ are two profiles in aluminium that allows to remove the small step between two floors with a respective difference in height of 8 and 12 mm. Available also in blister pack and with adhesive, they can be easily used in DIY installations.



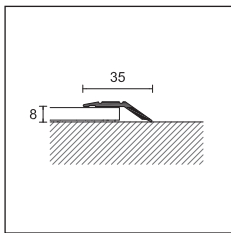

57/A silver anodised aluminium



55/



PROLEVEL HIGH

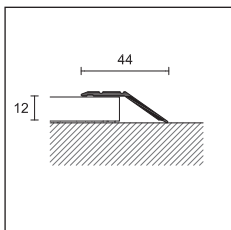

| | | | |
|------------------|---|------------------|---|
| pack | 20 pcs | 10 pcs / blister |  |
| length cm | 270 | 90 | |
| ART. | 55/ | 455/ | |
| finishing | F | A | CV AD |
| ALUMINIUM | | | |
| silver anodised |  73907 | 73937 | 42312 42330 |
| gold anodised |  - | 73947 | - 42336 |
| euro/m | | | - - |
| euro/pc | | | - - |

art. 55/ individually packed



57/

PROLEVEL HIGH

| | | | |
|------------------|---|------------------|---|
| pack | 20 pcs | 10 pcs / blister |  |
| length cm | 270 | 90 | |
| ART. | 57/ | 457/ | |
| finishing | F | A | CV AD |
| ALUMINIUM | | | |
| silver anodised |  73967 | 73997 | 42352 42370 |
| gold anodised |  - | 74007 | - 42376 |
| euro/m | | | - - |
| euro/pc | | | - - |

art. 57/ individually packed

Complete the item code with F=drilled, A-AD=adhesive, CV=screws (eg. 61/ adhesive becomes 61/A)

 packaging in blister no partial packaging

Prolevel 711/ and 311/ are a line of self-adhesive stainless steel and polished brass profiles which allows the elimination of the step between floors with 7 or 12 mm slope. Available also in blister pack and self-adhesive, they are easily applicable in DIY field.

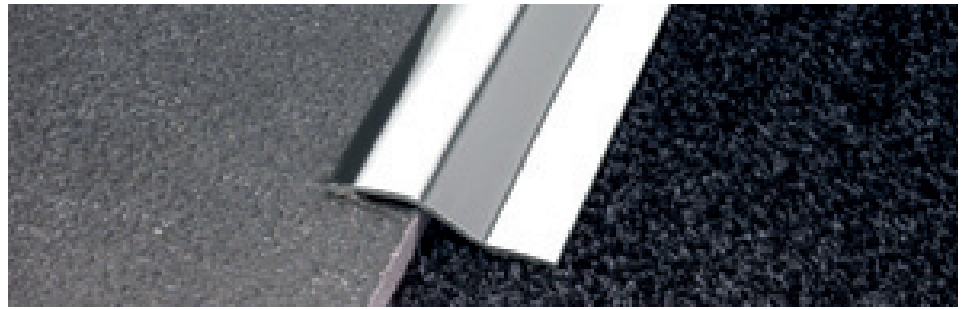



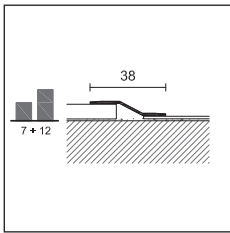

711/A polished stainless steel AISI 430 - DIN 1.4016



711/
311/



PROLEVEL HIGH

| | | | |
|---|--|--|-------|
| pack | 20 pcs | 10 pcs / blister  | |
| length cm | 270 | 83 | 93 |
| ART. | 711/ | 4711/ | |
| finishing | A | AD | AD |
| STAINLESS STEEL | | | |
| polished stainless steel AISI 430 - DIN 1.4016 |  73627 | 40431 | 40432 |
| euro/m | - | - | - |
| euro/pc | - | - | - |
| brushed stainless steel AISI 430 - DIN 1.4016 |  73628 | - | - |
| euro/m | - | - | - |
| ART. | 311/ | 4311/ | |
| finishing | A | AD | AD |
| BRASS | | | |
| polished |  73607 | - | 22656 |
| euro/m | - | - | - |
| euro/pc | - | - | - |

art. 711/ and 311/ individually packed

Prolevel 712/ and 312/ are a line of self-adhesive stainless steel and polished brass profiles which allows the elimination of the step between floors with 12 or 16 mm slope. Available also in blister pack and self-adhesive, they are easily applicable in DIY field.



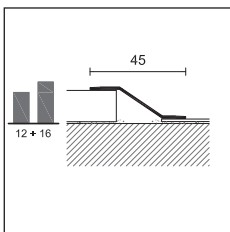

312/A polished brass



712/
312/



PROLEVEL HIGH

| | | | |
|---|---|---|--|
| pack | 10 pcs | 5 pcs / blister  | |
| length cm | 270 | 90 | |
| ART. | 712/ | 4712/ | |
| finishing | A | AD | |
| STAINLESS STEEL | | | |
| polished stainless steel AISI 430 - DIN 1.4016 |  73637 | 40898 | |
| euro/m | - | - | |
| euro/pc | - | - | |
| ART. | 312/ | 4312/ | |
| finishing | A | AD | |
| BRASS | | | |
| polished |  73617 | 40868 | |
| euro/m | - | - | |
| euro/pc | - | - | |

art. 712/ e 312/ individually packed

Complete the item code with A - AD=adhesive (eg. 711/ adhesive becomes 711/A) -  packaging in blister no partial packaging

prolevel

Prolevel High 732/ is a line of profiles for the protection of the perimetral border of floors. Available in stainless steel, it can be also used as stair nosing.



732/SF/10 polished stainless steel AISI 430 DIN 1.4016

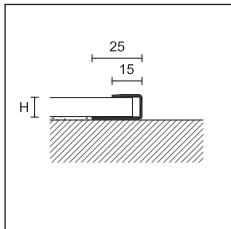

732/SF/



PROLEVEL HIGH

length = 270 cm - pack 15 pcs

| ART. | finishing | | H |
|------------------------|---|---|-------|
| | | 10 | 12,5 |
| STAINLESS STEEL | | | |
| 732/SF/ | polished stainless steel AISI 430 DIN 1.4016 |  | 74217 |
| | euro/m | | 74227 |

individually packed

Prolevel 700/, 300/ and 10/ are a line of transition profiles for floors of small thickness already laid. Available in different widths and also in blister pack, self-adhesive and with screws, they are easily applicable in DIY field.



700/A polished stainless steel AISI 430 DIN 1.4016

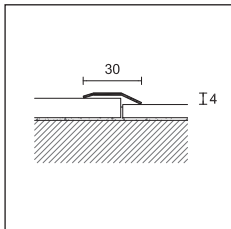

700/
300/



PROLEVEL MEDIUM

| pack | 20 pcs | | 10 pcs / blister |
|---|---|-------|------------------|
| length cm | 270 | 270 | 93 |
| ART. | 700/ | 701/ | 4701/ |
| finishing | A | F A | AD |
| STAINLESS STEEL | | | |
| polished stainless steel AISI 430 DIN 1.4016 |  | 72877 | - 72957 |
| euro/m | | | - |
| euro/pc | - | - | - |

art. 700/ and 701/ individually packed

PROLEVEL MEDIUM

| pack | 20 pcs | 10 pcs / blister |
|--------------|---|------------------|
| length cm | 270 | 93 |
| ART. | 300/ | 4300/ |
| finishing | A | AD |
| BRASS | | |
| polished |  | 72857 |
| euro/m | | 21035 |
| euro/pc | | - |

art. 300/ individually packed

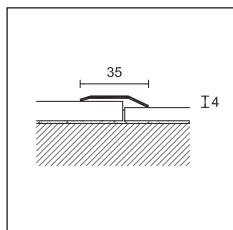

701/

Complete the article code with F=drilled, A-AD=adhesive, CV=screws (eg. 700/ drilled becomes 700/F)

 packaging in blister no partial packaging

Prolevel 6/ is a line of transition profiles in aluminium, for floors of small thickness already laid. Available also in blister pack, self-adhesive and with screws, they are easily applicable in DIY field.

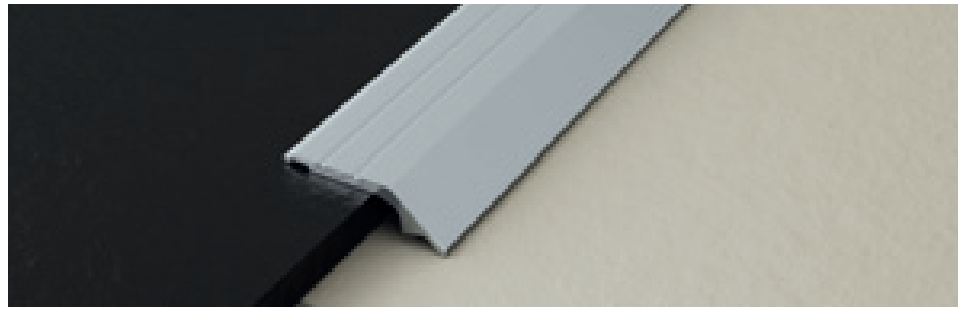



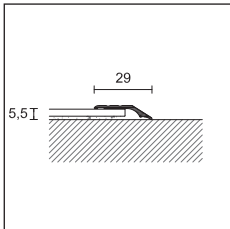

6/A silver anodised aluminium



6/



PROLEVEL MEDIUM

| | | | | | | |
|------------------|---|-------------|--|-------|-------|-------|
| pack | 30 pcs | | 10 pcs / blister  | | | |
| length cm | 270 | | 93 | 166 | | |
| ART. | 6/ | | 46/ | | | |
| finishing | F | A | CV | AD | CV | AD |
| ALUMINIUM | | | | | | |
| silver anodised |  | 72727 72757 | 20932 | 20952 | 20940 | 20960 |
| gold anodised |  | 72737 72767 | 20933 | 20953 | - | - |
| euro/m | | | - | - | - | - |
| euro/pc | | | - | - | - | - |
| bronze anodised |  | - 72777 | - | - | - | - |
| euro/m | | | - | - | - | - |

art. 6/ individually packed

Prolevel Medium 10/ and Prolevel Thin 54/ are two profiles for the connection of PVC floors. They can be installed on already-laid floors and they also acts as protection of the floor edge.



54/A gold anodised aluminium

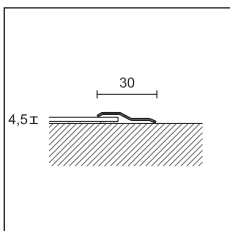

10/



PROLEVEL MEDIUM

| | | |
|------------------|---|-------|
| pack | 20 pcs | |
| length cm | 270 | |
| ART. | 10/ | |
| finishing | A | |
| ALUMINIUM | | |
| silver anodised |  | 72527 |
| euro/m | | |

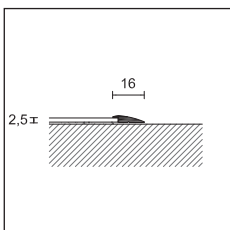

individually packed



54/



PROLEVEL THIN

| | | | |
|-------------------------------|-----------------|---|-------------|
| length = 270 cm - pack 20 pcs | | | |
| ART. | finishing | SF | A |
| ALUMINIUM | | | |
| 54/ | silver anodised |  | 72587 72617 |
| | gold anodised |  | - 72627 |
| | euro/m | | |

individually packed

Complete the item code with SF=undrilled, A-AD=adhesive, (eg. 54/ undrilled becomes 54/SF)

 packaging in blister no partial packaging





movement joints

A line designed to permit the expansion and contraction that materials undergo as a result of the seasonal temperature. A wide range of finishes to suit different stresses to which the coating is subjected.

cerfix® projoint

Projoint DIL NE is an expansion joint in co-extruded PVC. Suitable for the laying with glue, it is available in three colors and four heights and it is suitable for large areas with pedestrian traffic. Set on the joints created on the screed, it allows to absorb stresses of compression and expansion.

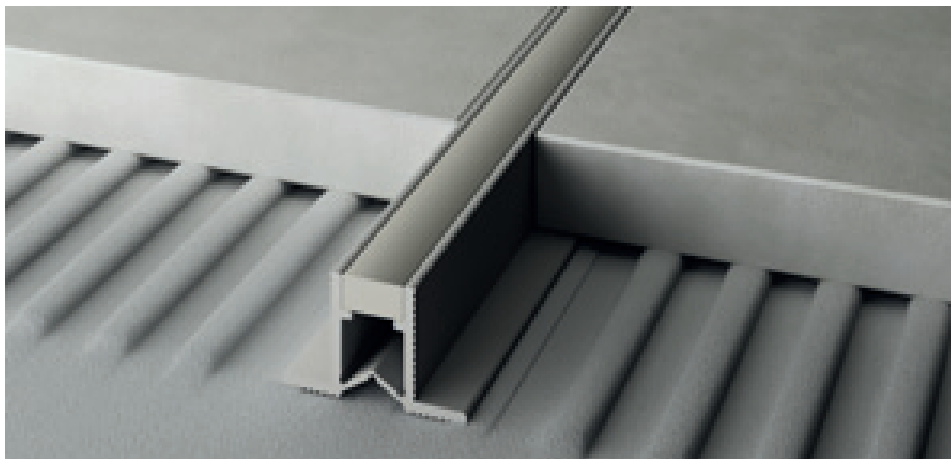

NE/10 co-extruded PVC grey + grey RAL 7035

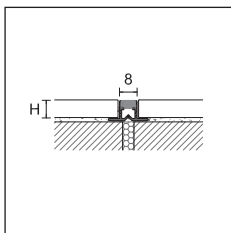

NE/



PROJOINT DIL

length = 270 cm

| ART. | finishing | 8 | 10 | 12,5 | 15 |
|------|-----------|---|----|------|----|
|------|-----------|---|----|------|----|

CO-EXTRUDED PVC

| | grey+grey RAL 7035 | | 99650 | 99660 | 99670 | 99680 |
|-----|----------------------------------|--|-------|-------|-------|-------|
| NE/ | stone grey+ stone grey RAL 7030 | | 99653 | 99663 | 99673 | 99683 |
| | cream white+cream white RAL 9001 | | 99652 | 99662 | - | - |

pack 20 pcs
euro/m

pack 100 pcs
euro/m

no partial packaging

Projoint DIL NJ/ is an expansion joint in co-extruded PVC with perforated side flanges. Suitable for floors laid with glue, it is able to absorb tensile and compression stresses, thanks to the elastic central part. Made of PVC non-toxic and anti shock, UV resistant and it can be used indoors and outdoors.

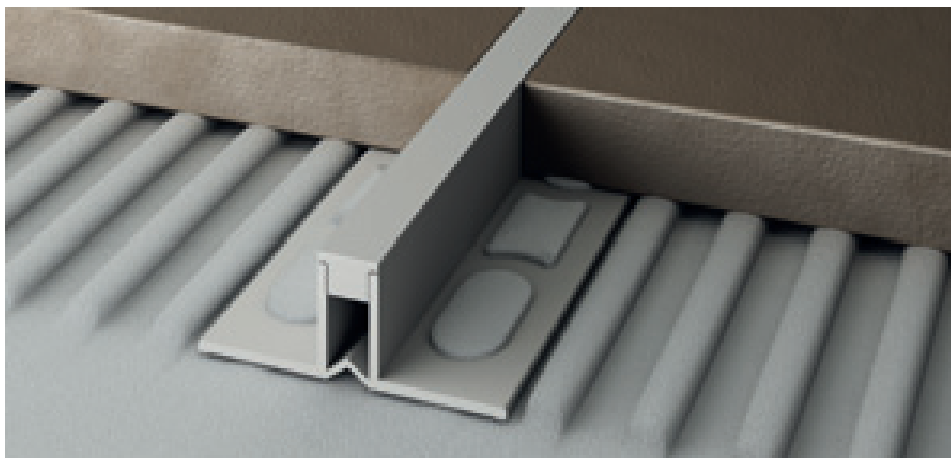

NJ/10 co-extruded PVC light grey RAL 7035

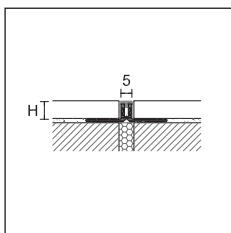

NJ/



PROJOINT DIL

length = 270 cm - pack 20 pcs

| ART. | finishing | 4,5 | 8 | 10 | 12,5 | 15 |
|------|-----------|-----|---|----|------|----|
|------|-----------|-----|---|----|------|----|

CO-EXTRUDED PVC

| | | | | | | | |
|-----|---------------------|--|-------|-------|-------|-------|-------|
| | light grey RAL 7035 | | 99757 | 99750 | 99760 | 99770 | 99780 |
| NJ/ | stone grey RAL 7030 | | 99758 | 99752 | 99762 | 99772 | 99782 |

euro/m

no partial packaging

Complete the article code with H measure (for example NE/ for H=8 becomes NE/8)

Projoint DIL NL/ is an expansion joint in co-extruded PVC with perforated side flanges. Suitable for floors or marble laid with glue, it is able to absorb tensile and compression stresses thanks to the elastic central part. It is suitable for both pedestrian traffic and light driveway (car and transpallet). Made of PVC non-toxic and anti shock, UV resistant and it can be used indoors and outdoors.



NL/10 co-extruded PVC grey + grey RAL 7035

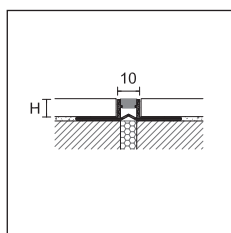

NL/



PROJOINT DIL

length = 270 cm - pack 20 pcs

| | | H | | | | |
|------------------------|---------------------------------|-------|-------|-------|-------|-------|
| ART. | finishing | 8 | 10 | 12,5 | 15 | 20 |
| CO-EXTRUDED PVC | | | | | | |
| NL/ | grey+grey RAL 7035 | 99700 | 99710 | 99720 | - | - |
| | stone grey+ stone grey RAL 7030 | 99704 | 99714 | 99724 | 99734 | 99744 |
| | black+black RAL 9005 | 99703 | 99713 | 99723 | - | - |

euro/m

no partial packaging

Projoint DIL NF is an expansion joint in co-extruded PVC for the laying with mortar. Available in three colors and three heights, it is suitable to divide large areas with pedestrian traffic. It allows to absorb compressive and expansion stresses.

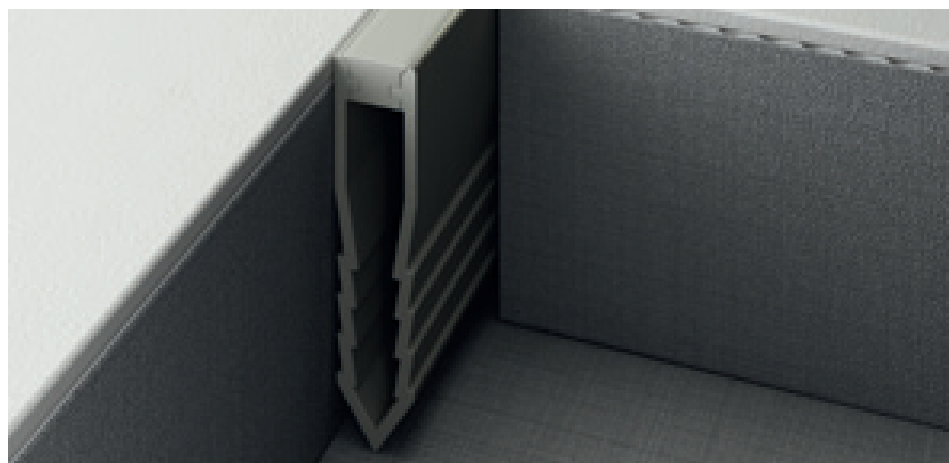

NF/45 co-extruded PVC grey + grey RAL 7035

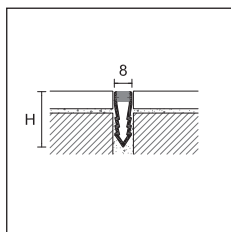

NF/



PROJOINT DIL

length = 270 cm

| | | H | | |
|------------------------|----------------------------------|-------|-------|-------|
| ART. | finishing | 25 | 35 | 45 |
| CO-EXTRUDED PVC | | | | |
| NF/ | grey+grey RAL 7035 | 99800 | 99810 | 99820 |
| | stone grey+ stone grey RAL 7030 | 99803 | 99813 | 99823 |
| | cream white+cream white RAL 9001 | 99802 | 99812 | - |

pack 20 pcs

euro/m

pack 40 pcs

euro/m

pack 50 pcs

euro/m

pack 80 pcs

euro/m

no partial packaging

Complete the article code with H measure (for example NL/ for H=10 becomes NL/10)

cerfix® projoint

Projoint DIL NAN is an expansion joint in aluminium, with an interchangeable insert in elastic vinyl resin, characterized by a visible section of 15 mm. The structure of the joint allows to protect the edge of the tile and is able to withstand high traffic, both pedestrian and vehicular.



NAN/10 natural aluminium + stone grey rubber

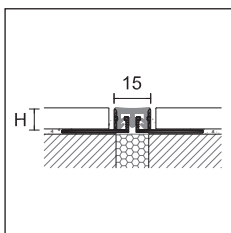

NAN/



PROJOINT DIL

length = 270 cm - pack 10 pcs

| | | H | | | |
|------------------|--|----|-------|-------|-------|
| ART. | finishing | 10 | 12,5 | 15 | |
| ALUMINIUM | | | | | |
| NAN/ | natural aluminium + grey RAL 7035 rubber | | 99974 | 99975 | 99976 |
| | natural aluminium + stone grey RAL 7030 rubber | | 99977 | 99978 | 99979 |

euro/m

individually packed - NAN/ available with black rubber upon request, minimum order 100 pcs

SPARE INSERT FOR NAN/

length= 270 cm - pack 20 pcs

| ART. | finishing | | |
|------|---------------------|--|-------|
| GM/I | grey RAL 7035 | | 99993 |
| | stone grey RAL 7030 | | 99989 |

euro/m

Projoint DIL NPAN/ is an expansion joint in aluminium, with an interchangeable insert in elastic vinyl resin, characterized by a visible section of 21 mm. The structure of the joint allows to protect the edge of the tile and is able to withstand high traffic, both pedestrian and vehicular.



NPAN/10 natural aluminium + stone grey rubber

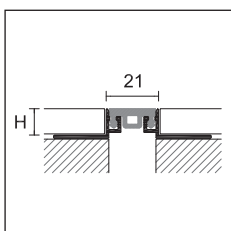

NPAN/



PROJOINT DIL

length = 270 cm - pack 10 pcs

| | | H | | | |
|------------------|--|----|-------|-------|-------|
| ART. | finishing | 10 | 12,5 | 15 | |
| ALUMINIUM | | | | | |
| NPAN/ | natural aluminium + stone grey RAL 7030 rubber | | 99984 | 99985 | 99986 |

euro/m

individually packed - NPAN/ available with black rubber upon request, minimum order 100 pcs

SPARE INSERT FOR NPAN/

length= 270 cm - pack 20 pcs

| ART. | finishing | | |
|-------|---------------------|--|-------|
| GMP/I | stone grey RAL 7030 | | 99988 |

euro/m

Complete the article code with H measure (for example NAN/ for H=10 becomes NAN/10)

Projoint DIL NIN/ is an expansion joint in stainless steel, with an interchangeable insert in elastic vinyl resin, characterized by a reduced section of 15 mm. The structure of the joint allows to protect the edge of the tile and is able to withstand heavy traffic, both pedestrian and vehicular (forklifts, transpallets and cars).

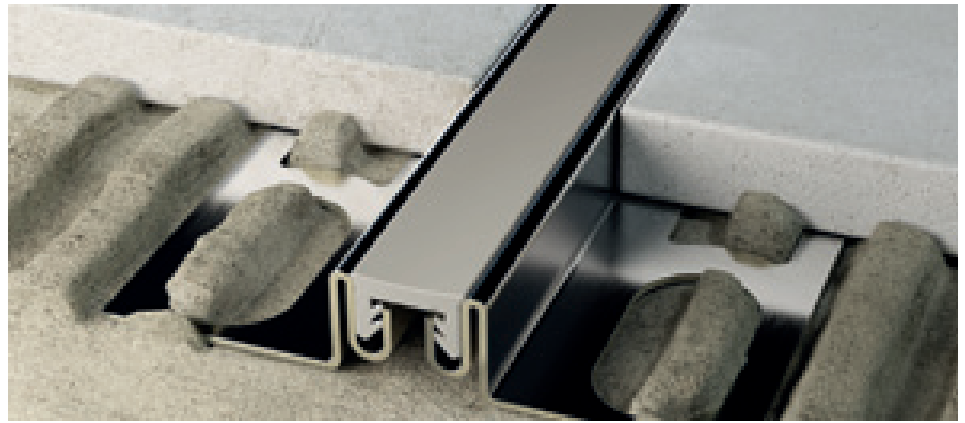

NIN/10 stainless steel + stone grey rubber

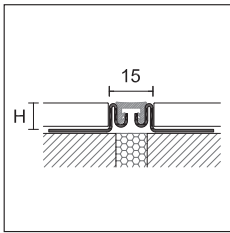

NIN/



PROJOINT DIL

length = 270 cm - pack 5 pcs

| | | H | | | |
|------|-----------|----|------|----|----|
| ART. | finishing | 10 | 12,5 | 15 | 20 |

STAINLESS STEEL

| | | | | | | |
|---------------|--|--|-------|-------|-------|-------|
| NIN/ | stainless steel AISI 304 DIN 1.4301 + grey RAL 7035 rubber | | 99915 | 99916 | 99917 | 99918 |
| | stainless steel AISI 304 DIN 1.4301 + stone grey RAL 7030 rubber | | 99925 | 99926 | 99927 | 99928 |
| euro/m | | | | | | |

individually packed - NIN/ available with black rubber upon request, minimum order 100 pcs

SPARE INSERT FOR NIN/

length= 270 cm - pack 20 pcs

| ART. | finishing | | | | |
|------|-----------|--|--|--|--|
|------|-----------|--|--|--|--|

| | | | | | |
|---------------|---------------------|--|-------|--|--|
| GM/10 | grey RAL 7035 | | 99998 | | |
| | stone grey RAL 7030 | | 99999 | | |
| euro/m | | | | | |

Projoint DIL NIL/ is a perimeter expansion joint in stainless steel, with an interchangeable insert in elastic vinyl resin, characterized by a visible section of 14 mm. The structure of the joint allows to connect the floor to the wall and is able to withstand heavy traffic, both pedestrian and vehicular (forklifts, transpallets and cars).



NIL/10 stainless steel + stone grey rubber

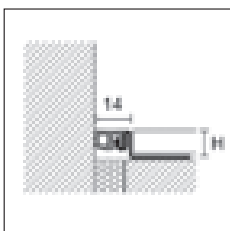

NIL/



PROJOINT DIL

length = 270 cm - pack 5 pcs

| | | H | | | |
|------|-----------|----|------|----|----|
| ART. | finishing | 10 | 12,5 | 15 | 20 |

STAINLESS STEEL

| | | | | | | |
|------|--|--|-------|-------|-------|-------|
| NIL/ | stainless steel AISI 304 DIN 1.4301 + stone grey RAL 7030 rubber | | 99896 | 99897 | 99898 | 99899 |
| | euro/m | | | | | |

individually packed - NIL/ available with black rubber upon request, minimum order 100 pcs

SPARE INSERT FOR NIL/

length= 270 cm - pack 20 pcs

| ART. | finishing | | | | |
|------|-----------|--|--|--|--|
|------|-----------|--|--|--|--|

| | | | | | |
|---------------|---------------------|--|-------|--|--|
| GM12/L | stone grey RAL 7030 | | 99987 | | |
| euro/m | | | | | |

Complete the article code with H measure (for example NIN/ for H=10 becomes NIN/10)

Projoint NTA/, NTI/ and NTO/ are expansion joints for the laying with glue with inner section in vulcanized EPDM. The metal structure easily stands up to the recurring pedestrian and vehicular traffic (forklift trucks, transpallets and cars).



NTA/10 natural aluminium + EPDM grey polishable RAL 7046

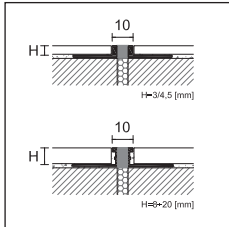

NTA/
NTO/

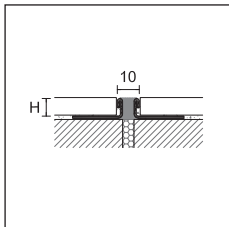

NTI/

PROJOINT DIL

length = 270 cm - pack 10 pcs

| ART. | finishing | 3 | 4,5 | 8 | 10 | 12,5 | 15 | 20 |
|------------------------|---|-------|-------|-------|-------|-------|-------|-------|
| ALUMINIUM | | | | | | | | |
| | natural aluminium + EPDM grey polishable RAL 7046 | 99421 | 99425 | 99441 | 99445 | 99449 | 99453 | 99457 |
| | natural aluminium + EPDM black polishable RAL 9005 | 99422 | 99426 | 99442 | 99444 | 99450 | 99454 | 99458 |
| NTA/ | euro/m | | | | | | | |
| | natural aluminium + EPDM bahama polishable RAL 10070 | 99427 | 99428 | - | - | - | - | - |
| | natural aluminium + EPDM brown polishable RAL 10071 | 99429 | 99430 | - | - | - | - | - |
| | euro/m | | | | | | | |
| STAINLESS STEEL | | | | | | | | |
| | stainless steel AISI 304 DIN 1.4301 + EPDM grey RAL 7046 | 99471 | 99475 | 99481 | 99485 | 99489 | 99493 | 99497 |
| | stainless steel AISI 304 DIN 1.4301 + EPDM black RAL 9005 | 99472 | 99474 | 99482 | 99486 | 99490 | - | - |
| NTI/ | euro/m | | | | | | | |
| | stainless steel AISI 304 DIN 1.4301 + EPDM bahama RAL 10070 | 99431 | 99432 | - | - | - | - | - |
| | stainless steel AISI 304 DIN 1.4301 + EPDM brown RAL 10071 | 99433 | 99434 | - | - | - | - | - |
| | euro/m | | | | | | | |
| NTO/ | brass natural + EPDM grey polishable RAL 7046 | - | - | 99401 | 99405 | 99409 | 99413 | 99417 |
| | euro/m | - | - | | | | | |

art. NTO/15 and NTO/20 pack 5 pcs

Projoint STA/ and STI/ are expansion joints for the division of floors laid with mortar, with inner section in vulcanized EPDM. The metal structure easily withstands the recurring pedestrian and vehicular traffic (forklift trucks, transpallets and cars), making them particularly suitable for shopping malls and frequent passage of loads. We suggest the use of the stainless steel hooks ST/7 for the installation.



STI/40 stainless steel AISI 304 DIN 1.4301 + EPDM grey polishable RAL 7046

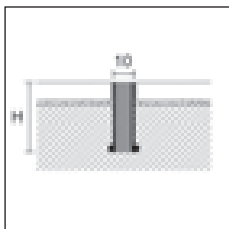

STA/
STI/

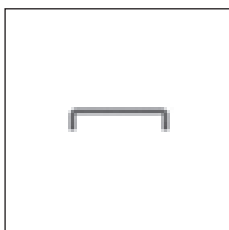

ST/7

PROJOINT DIL

length = 250 cm - pack 10 pcs

| ART. | finishing | 30 | 40 | 50 |
|------------------|---|-------|-------|-------|
| ALUMINIUM | | | | |
| STA/ | natural aluminium + EPDM grey polishable RAL 7046 | 99581 | 99585 | 99589 |
| | euro/m | | | |
| STI/ | stainless steel AISI 304 DIN 1.4301 + EPDM grey polishable RAL 7046 | 99621 | 99625 | 99629 |
| | euro/m | | | |

Upon request, we can make different measures and colours for articles STA/ and STI/. Please contact our sales department

ACCESSORIES

pack 100 pcs

| ART. | finishing | |
|------------------------|---------------------------------------|-------|
| STAINLESS STEEL | | |
| ST/7 | steel hook for STA/ and STI/ profiles | 99640 |
| | euro/pc (euro/pack) | |

no partial packaging

Projoint NZA is an expansion joint in aluminium consisting of two interlocking and sliding profiles. Suitable for ceramic floors subjected to intense traffic, it ensures a high resistance to loads and high traffic both pedestrian and vehicular (forklifts, transpallet and cars).



NZA/10 natural aluminium

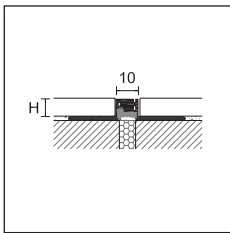

NZA/



PROJOINT DIL

length = 270 cm - pack 20 pcs

| | | H | | | | |
|------------------|-------------------|-------|-------|-------|-------|-------|
| ART. | finishing | 3 | 5 | 8 | 10 | 12,5 |
| ALUMINIUM | | | | | | |
| NZA/ | natural aluminium | - | - | 99910 | 99912 | 99914 |
| | euro/m | - | - | | | |
| NZA/ | silver anodised | 99300 | 99320 | - | - | - |
| | euro/m | | | - | - | - |

individually packed

Projoint NZS is an expansion joint in aluminium with high absorption. Thanks to the 2 interlocking parts, the joint can absorb movements of +/- 5 mm with articulated flins that permit tridimensional movements. The structure of the joint protects the edge of the tile, and it bears the pedestrian and vehicular passage. NZS is also available as a joint cover (when tiles are already laid), NZS/A, or side joint for industrial buildings, NZS/L.



NZS/10 silver anodised aluminium



NZS/A/40 silver anodised aluminium

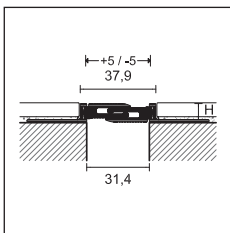

NZS/



PROJOINT DIL

length = 270 cm - pack 5 pcs

| | | H | | | |
|------------------|-----------------|-------|-------|-------|-------|
| ART. | finishing | 10 | 12,5 | 15 | 20 |
| ALUMINIUM | | | | | |
| NZS/ | silver anodised | 99880 | 99881 | 99882 | 99883 |
| | euro/m | | | | |

PROJOINT DIL

length = 270 cm - pack 5 pcs

| | | H |
|------------------|-----------------|-------|
| ART. | finishing | 8 |
| ALUMINIUM | | |
| NZS/A/40 | silver anodised | 99885 |
| | euro/m | |

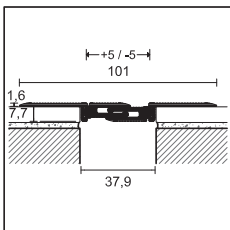

NZS/A/40

PROJOINT DIL

length = 270 cm - pack 5 pcs

| | | H | | | |
|------------------|-----------------|-------|-------|-------|-------|
| ART. | finishing | 10 | 12,5 | 15 | 20 |
| ALUMINIUM | | | | | |
| NZS/L/ | silver anodised | 99890 | 99891 | 99892 | 99893 |
| | euro/m | | | | |

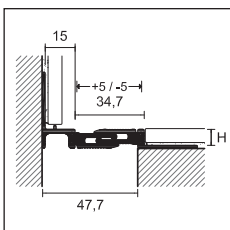

NZS/L/

Complete the article code with H measure (for example NZA/ for H=8 becomes NZA/8)

cerfix® projoint

Projoint DIL PBE is a structural joint composed of two L-shaped profiles in natural aluminium and an expanding part in interchangeable plasticized PVC, available in black or grey. The two L-shaped profiles have drilled bases to allow the mechanical fixing with screws to the underlying structure.



PBE/30 natural aluminium + striated black rubber

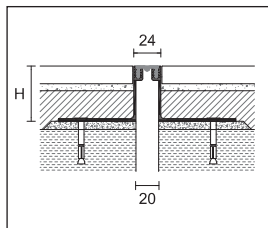

PBE/20 smooth rubber

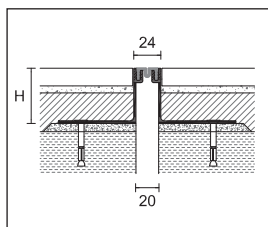

PBE/20 striated rubber

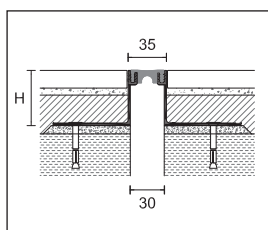

PBE/30 smooth rubber

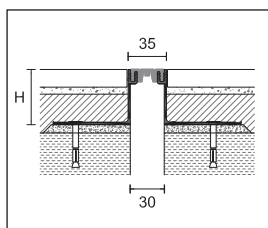

PBE/30 striated rubber

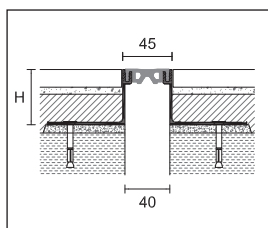

PBE/40 smooth rubber

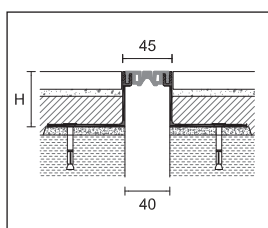

PBE/40 striated rubber

PROJOINT DIL

length = 300 cm - pack 5 pcs

| ART. | finishing | 14 | 24 | 42 | 50 | 82 |
|-----------------------|---|-------|-------|-------|-------|-------|
| ALUMINIUM | | | | | | |
| | natural aluminium + smooth grey rubber | 99321 | 99322 | 99323 | 99324 | 99325 |
| | natural aluminium + smooth black rubber | 99326 | 99327 | 99328 | 99329 | 99330 |
| PBE/20/ euro/m | | | | | | |
| | natural aluminium + striated grey rubber | 99331 | 99332 | 99333 | 99334 | 99335 |
| | natural aluminium + striated black rubber | 99336 | 99337 | 99338 | 99339 | 99340 |

no partial packaging - profiles are provided with accessories for mechanical fixing



smooth rubber



striated rubber

PROJOINT DIL

length = 300 cm - pack 5 pcs

| ART. | finishing | 14 | 24 | 42 | 50 | 82 |
|-----------------------|---|-------|-------|-------|-------|-------|
| ALUMINIUM | | | | | | |
| | natural aluminium + smooth grey rubber | 99341 | 99342 | 99343 | 99344 | 99345 |
| | natural aluminium + smooth black rubber | 99346 | 99347 | 99348 | 99349 | 99350 |
| PBE/30/ euro/m | | | | | | |
| | natural aluminium + striated grey rubber | 99351 | 99352 | 99353 | 99354 | 99355 |
| | natural aluminium + striated black rubber | 99356 | 99357 | 99358 | 99359 | 99360 |

no partial packaging - profiles are provided with accessories for mechanical fixing



smooth rubber



striated rubber

PROJOINT DIL

length = 300 cm - pack 5 pcs

| ART. | finishing | 14 | 24 | 42 | 50 | 82 |
|-----------------------|---|-------|-------|-------|-------|-------|
| ALUMINIUM | | | | | | |
| | natural aluminium + smooth grey rubber | 99361 | 99362 | 99363 | 99364 | 99365 |
| | natural aluminium + smooth black rubber | 99366 | 99367 | 99368 | 99369 | 99370 |
| PBE/40/ euro/m | | | | | | |
| | natural aluminium + striated grey rubber | 99371 | 99372 | 99373 | 99374 | 99375 |
| | natural aluminium + striated black rubber | 99376 | 99377 | 99378 | 99379 | 99380 |

no partial packaging - profiles are provided with accessories for mechanical fixing



smooth rubber



striated rubber

We suggest the use of the black insert.

Delivery times to be agreed.

Projoint DIL PBH and PAS are two structural joints composed of two L-shaped profiles in natural aluminium and an expanding part in interchangeable EPDM, available in black or grey. Projoint DIL PHDE is a structural joint composed of two interlocking and sliding profiles in natural aluminium. All profiles have drilled bases to allow the mechanical fixing with screws to the underlying structure and are designed to withstand structural movements of big buildings.

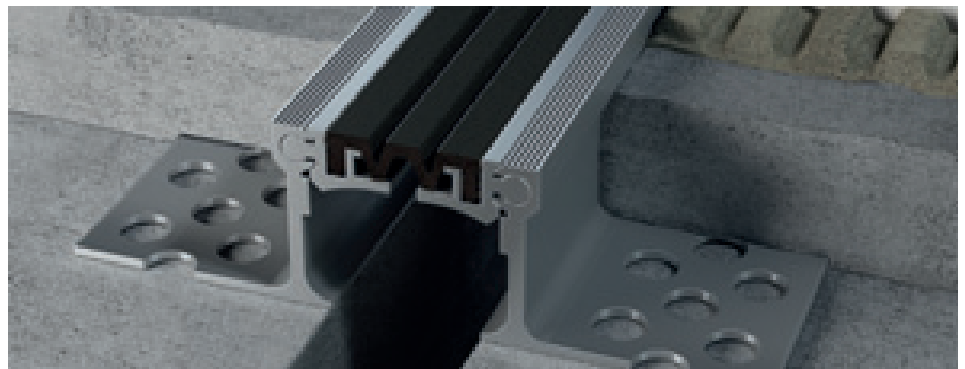

PBH/65/ natural aluminium + black EPDM insert

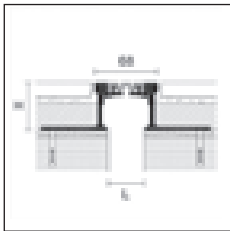

PBH/65



PROJOINT DIL

length = 300 cm - pack 2 pcs

| | | H | | | |
|------------------|---------------------------------------|-------------|-------------|-------------|-------------|
| ART. | finishing | 18 | 35 | 50 | 80 |
| ALUMINIUM | | L=50 | L=40 | L=40 | L=40 |
| PBH/65/ | natural aluminium + grey EPDM insert | 99500 | 99501 | 99502 | 99503 |
| | natural aluminium + black EPDM insert | 99504 | 99505 | 99506 | 99507 |

euro/m

no partial packaging - profiles are provided with accessories for mechanical fixing

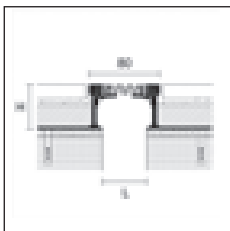

PBH/75

PROJOINT DIL

length = 300 cm - pack 2 pcs

| | | H | | | |
|------------------|---------------------------------------|-------------|-------------|-------------|-------------|
| ART. | finishing | 18 | 35 | 50 | 80 |
| ALUMINIUM | | L=60 | L=50 | L=50 | L=50 |
| PBH/75/ | natural aluminium + grey EPDM insert | 99508 | 99509 | 99510 | 99511 |
| | natural aluminium + black EPDM insert | 99512 | 99513 | 99514 | 99515 |

euro/m

no partial packaging - profiles are provided with accessories for mechanical fixing

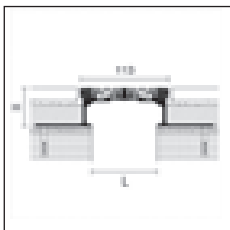

PAS/105



PROJOINT DIL

length = 300 cm - pack 2 pcs

| | | H | | | |
|------------------|---------------------------------------|-------------|-------------|-------------|-------------|
| ART. | finishing | 18 | 35 | 50 | 80 |
| ALUMINIUM | | L=95 | L=85 | L=85 | L=85 |
| PAS/105/ | natural aluminium + grey EPDM insert | 99516 | 99517 | 99518 | 99519 |
| | natural aluminium + black EPDM insert | 99520 | 99521 | 99522 | 99523 |

euro/m

no partial packaging - profiles are provided with accessories for mechanical fixing

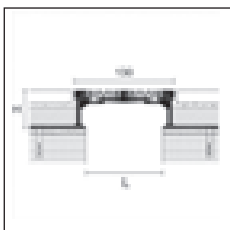

PAS/125

PROJOINT DIL

length = 300 cm - pack 2 pcs

| | | H | | | |
|------------------|---------------------------------------|--------------|--------------|--------------|--------------|
| ART. | finishing | 18 | 35 | 50 | 80 |
| ALUMINIUM | | L=111 | L=100 | L=100 | L=100 |
| PAS/125/ | natural aluminium + grey EPDM insert | 99524 | 99525 | 99526 | 99527 |
| | natural aluminium + black EPDM insert | 99528 | 99529 | 99530 | 99531 |

euro/m

no partial packaging - profiles are provided with accessories for mechanical fixing

We suggest the use of the black insert.

cerfix® projoint

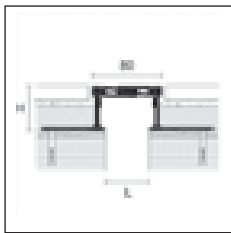

PHDE/80

PROJOINT DIL

| | | | | | |
|------------------------------|-------------------|-------------|-------------|-------------|-------------|
| length = 300 cm - pack 2 pcs | | H | | | |
| ART. | finishing | 18 | 35 | 50 | 80 |
| ALUMINIUM | | L=60 | L=50 | L=50 | L=50 |
| PHDE/80/ | natural aluminium | 99590 | 99591 | 99592 | 99593 |
| | <i>euro/m</i> | | | | |

no partial packaging - profiles are provided with accessories for mechanical fixing

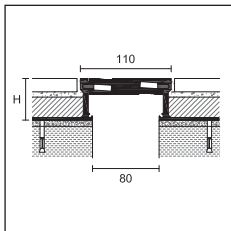

PHDE/110

PROJOINT DIL

| | | | | | |
|------------------------------|-------------------|----------|-----------|-----------|-------|
| length = 300 cm - pack 2 pcs | | H | | | |
| ART. | finishing | | 50 | 80 | |
| ALUMINIUM | | | | | |
| PHDE/110/ | natural aluminium | | 99594 | | 99595 |
| | <i>euro/m</i> | | | | |

no partial packaging - profiles are provided with accessories for mechanical fixing

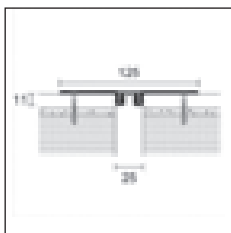

PFFE/20

PROJOINT DIL

| | | | | | |
|------------------------------|--|--|--|--|-------|
| length = 300 cm - pack 5 pcs | | | | | |
| ART. | finishing | | | | |
| ALUMINIUM | | | | | |
| | natural aluminium + smooth grey rubber | | | | 99596 |
| | natural aluminium + smooth black rubber | | | | 99597 |
| PFFE/20 | <i>euro/m</i> | | | | |
| | natural aluminium + striated grey rubber | | | | 99598 |
| | natural aluminium + striated black rubber | | | | 99599 |
| | <i>euro/m</i> | | | | |

no partial packaging - profiles are provided with accessories for mechanical fixing



smooth rubber striated rubber

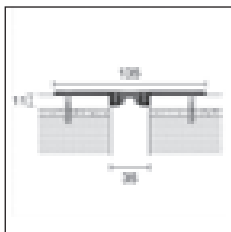

PFFE/30

PROJOINT DIL

| | | | | | |
|------------------------------|--|--|--|--|-------|
| length = 300 cm - pack 5 pcs | | | | | |
| ART. | finishing | | | | |
| ALUMINIUM | | | | | |
| | natural aluminium + smooth grey rubber | | | | 99600 |
| | natural aluminium + smooth black rubber | | | | 99601 |
| PFFE/30 | <i>euro/m</i> | | | | |
| | natural aluminium + striated grey rubber | | | | 99602 |
| | natural aluminium + striated black rubber | | | | 99603 |
| | <i>euro/m</i> | | | | |

no partial packaging - profiles are provided with accessories for mechanical fixing



smooth rubber striated rubber

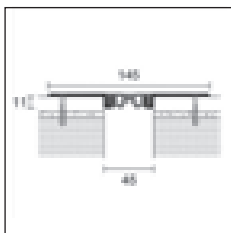

PFFE/40

PROJOINT DIL

| | | | | | |
|------------------------------|--|--|--|--|-------|
| length = 300 cm - pack 5 pcs | | | | | |
| ART. | finishing | | | | |
| ALUMINIUM | | | | | |
| | natural aluminium + smooth grey rubber | | | | 99604 |
| | natural aluminium + smooth black rubber | | | | 99605 |
| PFFE/40 | <i>euro/m</i> | | | | |
| | natural aluminium + striated grey rubber | | | | 99606 |
| | natural aluminium + striated black rubber | | | | 99607 |
| | <i>euro/m</i> | | | | |

no partial packaging - profiles are provided with accessories for mechanical fixing



smooth rubber striated rubber

Procover Flex is a line of structural aluminium joint covers designed to withstand traction and compression transverse movements of large buildings.

They withstand both pedestrian and vehicular traffic with rubber wheels (cars).

Procover Fix is a line of flat joint cover profiles in aluminium for coplanar floors (GJA/) and perimeter joint cover profiles for the connection of floors and walls (GWA/), suitable to cover structural movements of expansion or compression of two different structures.

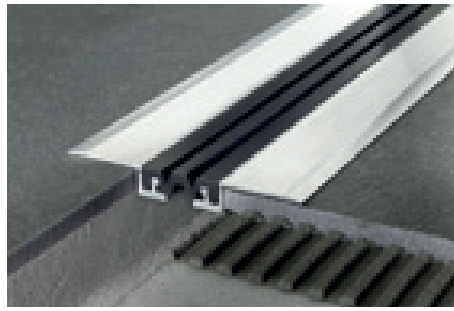

GJF/40 natural aluminium + EPDM black RAL 9005

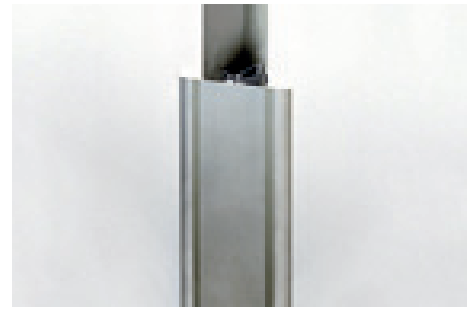

GJA/70 silver anodised aluminium

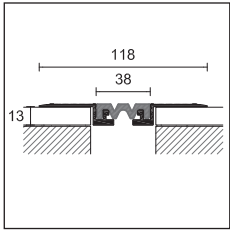

GJF/40



PROCOVER FLEX

length = 400 cm - pack 5 pcs

L

| ART. | finishing | 40 | 50 |
|------|-----------|----|----|
|------|-----------|----|----|

ALUMINIUM

| | | | | |
|------|--|--|-------|-------|
| GJF/ | natural aluminium + EPDM black insert RAL 9005 | | 74490 | 74492 |
| | euro/m | | | |

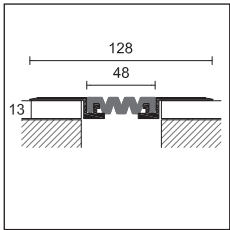

GJF/50

SPARE INSERT

length = 400 cm

L

| ART. | finishing | 40 | 50 |
|------|-----------|----|----|
|------|-----------|----|----|

ALUMINIUM

| | | | | |
|-----|---------------------|--|-------|-------|
| GM/ | EPDM black RAL 9005 | | 74491 | 74493 |
| | euro/m | | | |

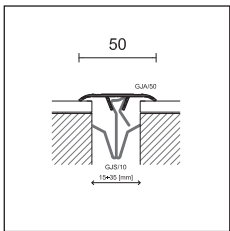

GJA/50



PROCOVER FIX

length = 300 cm - pack 10 pcs

L

| ART. | finishing | 50 | 70 |
|------|-----------|----|----|
|------|-----------|----|----|

ALUMINIUM

| | | | | |
|------|-----------------|--|-------|-------|
| GJA/ | silver anodised | | 74550 | 74610 |
| | euro/m | | | |
| GWA/ | silver anodised | | - | 74552 |
| | euro/m | | - | |

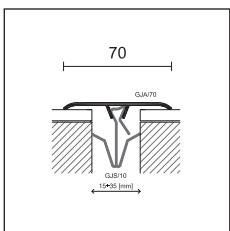

GJA/70

SPRING CLIP

from 15 to 35 mm - pack 50 pcs

STAINLESS STEEL

| | | | |
|--------|----------------|--|-------|
| GJS/10 | harmonic steel | | 74730 |
| | euro/pc | | |

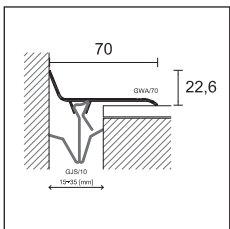

GWA/70

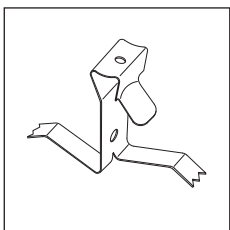

GJS/10

Complete the article code with L measure (for example GJF/ for L=40 becomes GJF/40)

cerfix® procover

Procover G in anodized aluminium are joint covering profiles, suitable for creating continuity on structures with continuous bays. These joint coverings are supplied with adhesive or are fixed with screws and dowels.

In this case it is perforated laterally, and fixed only to one structure allowing the free sliding over the other.



G/80/A silver anodised aluminium

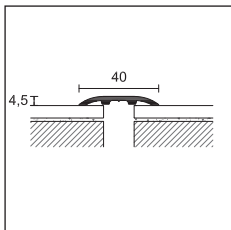

G/40/

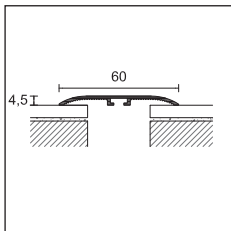

G/60/

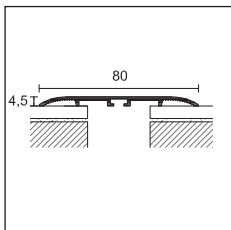

G/80/

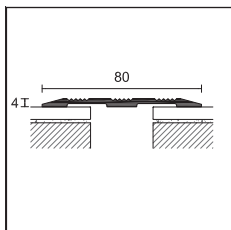

GR/80/SF

PROCOVER

| pack | 20 pcs | 20 pcs | 6 pcs / blister | 20 pcs | | |
|------------------|--------|--------|-----------------|--------|-------|-------|
| length cm | 300 | 300 | 100 | 300 | | |
| ART. | G/40/ | G/60/ | G/460/ | G/80/ | | |
| finishing | A | SF | A | AD | SF | A |
| ALUMINIUM | | | | | | |
| silver anodised | 74528 | 74558 | 74588 | 21982 | 74618 | 74648 |
| euro/m | | | | - | | |
| euro/pc | - | - | - | | - | - |

art. G/40, G/60 and G/80 individually packed

PROCOVER

| | |
|-------------------------------|--------|
| length = 270 cm - pack 10 pcs | L |
| width | 80 |
| ART. | GR/80/ |
| finishing | SF |
| ALUMINIUM | |
| silver anodised | 71855 |
| euro/m | |

individually packed

Complete the article code with A-AD=adhesive, SF=undrilled (for example G/40/ adhesive becomes G/40/A)

packaging in blister no partial packaging



GR/80/SF silver anodised aluminium

Procover G in stainless steel and polished brass are joint covering profiles, suitable for creating continuity on structures with continuous bays. These joint coverings are supplied with adhesive or are fixed with screws and dowels. In this case it is perforated laterally, and fixed only to one structure allowing the free sliding over the other. In these versions they are suitable even to vehicular traffic.

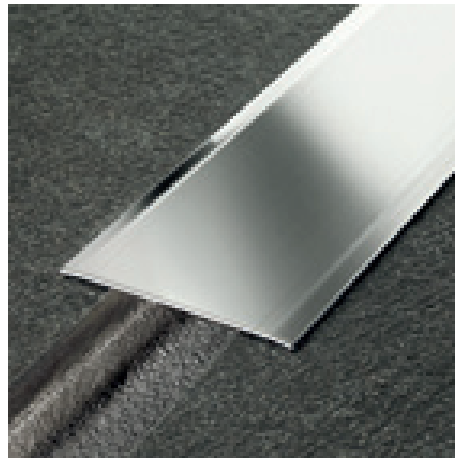

760/SF polished stainless steel AISI430-DIN 1.4016

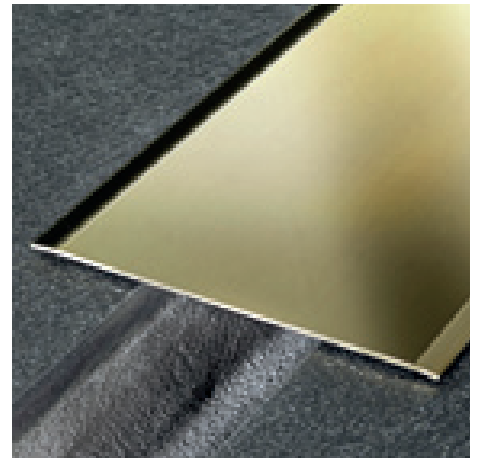

0100/A polished brass

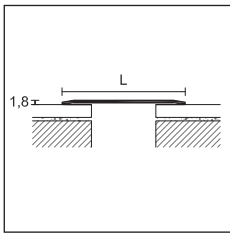

PROCOVER

| | 10 pcs | | 6 pcs / blister | | 10 pcs | | 6 pcs / blister | | 5 pcs | | 3 pcs / blister | | 5 pcs | |
|-----------|--------|---|-----------------|----|--------|----|-----------------|---|-------|----|-----------------|----|-------|---|
| length cm | 300 | | 100 | | 300 | | 100 | | 300 | | 100 | | 300 | |
| width mm | 50 | | 50 | | 60 | | 60 | | 80 | | 80 | | 100 | |
| thickness | 12/10 | | | | | | | | | | | | | |
| ART. | 750/ | | 4750/ | | 760/ | | 4760/ | | 780/ | | 4780/ | | 7100/ | |
| finishing | SF | A | AD | SF | A | AD | SF | A | AD | SF | A | AD | SF | A |

STAINLESS STEEL

| | | | | | | | | | | | |
|--|-------|-------|-------|-------|-------|-------|-------|-------|-------|-------|-------|
| polished stainless steel AISI 430 - DIN 1.4016 | 74818 | 74828 | 22090 | 74838 | 74848 | 40531 | 74858 | 74868 | 40553 | 74878 | 74888 |
| euro/m | - | - | - | - | - | - | - | - | - | - | - |
| euro/pc | - | - | - | - | - | - | - | - | - | - | - |

art. 750/, 760/, 780/, 7100/ individually packed

PROCOVER

| | 10 pcs | | 6 pcs / blister | | 5 pcs | | 6 pcs / blister | | 5 pcs | | 3 pcs / blister | | 5 pcs. | |
|-----------|--------|---|-----------------|----|-------|----|-----------------|---|-------|----|-----------------|----|--------|---|
| length cm | 300 | | 100 | | 300 | | 100 | | 300 | | 100 | | 300 | |
| width mm | 50 | | 50 | | 60 | | 60 | | 80 | | 80 | | 100 | |
| thickness | 13/10 | | | | | | | | | | | | | |
| ART. | 050/ | | 4050/ | | 060/ | | 4060/ | | 080/ | | 4080/ | | 0100/ | |
| finishing | SF | A | AD | SF | A | AD | SF | A | AD | SF | A | AD | SF | A |

STAINLESS STEEL

| | | | | | | | | | | | |
|----------|-------|-------|-------|-------|-------|-------|---|-------|-------|-------|-------|
| polished | 74738 | 74748 | 22050 | 74758 | 74768 | 40504 | - | 74788 | 40512 | 74798 | 74808 |
| euro/m | - | - | - | - | - | - | - | - | - | - | - |
| euro/pc | - | - | - | - | - | - | - | - | - | - | - |

art. 050/, 060/, 080/, 0100/ individually packed

Complete the article code with A-AD=adhesive, SF=undrilled (eg. 050/ adhesive becomes 050/A)

 packaging in blister no partial packaging



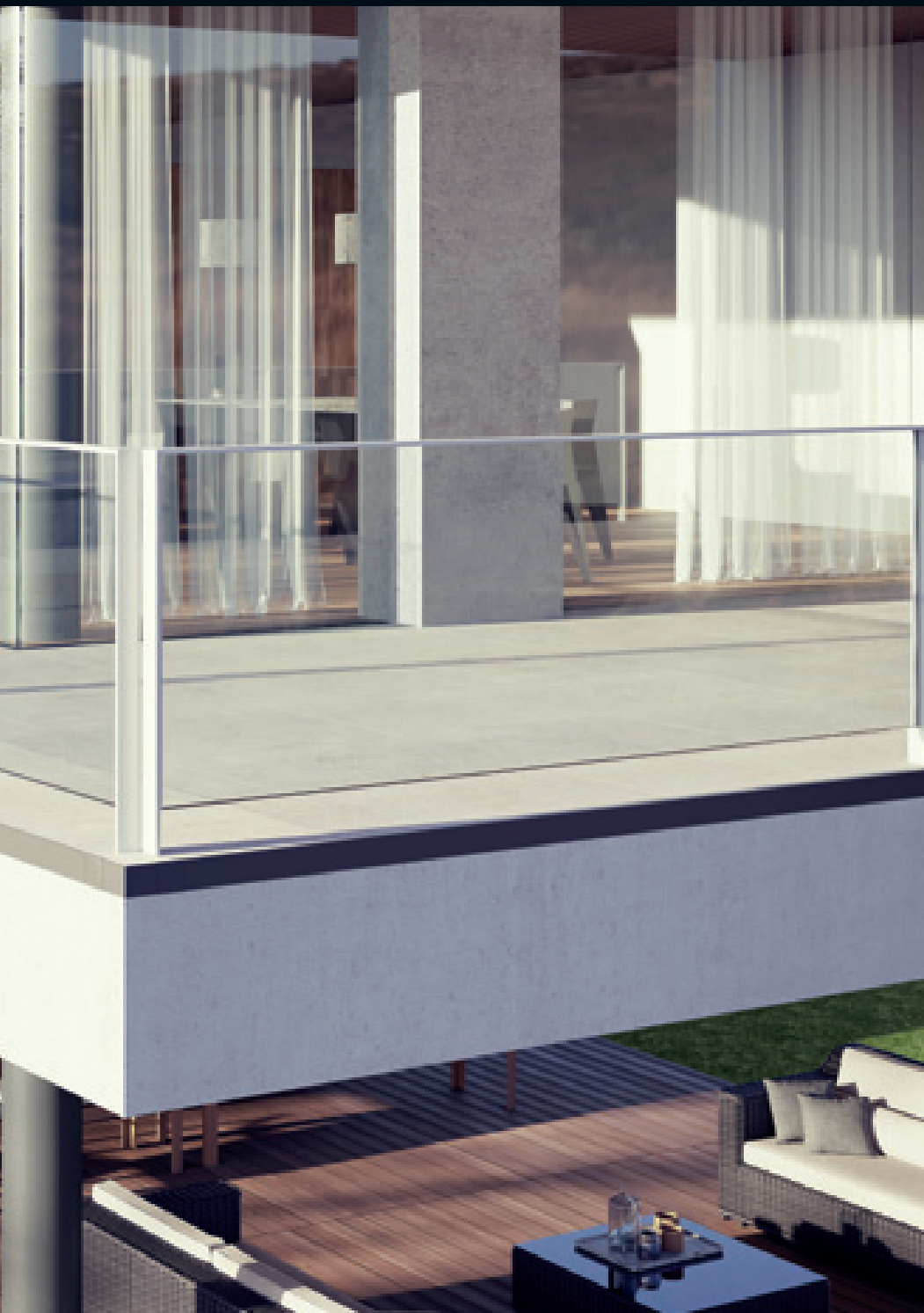

profiles for balconies and terraces

A functional and stylish line for the protection of terraces, balconies and pavements. The effectiveness of the protection decorates and completes every architectural detail.

Protec CPCV and CPCI are a series of edge profiles for the protection and the finishing of the outside edges of terraces and balconies. Available in colour-coated aluminium and stainless steel, they have been designed with a protruding section and can be used with tiles thicknesses up to 21 mm. In addition to protecting and finishing the outside edges, they guarantee the outflow of water from the floor, avoiding the contact with the outside border.

Protec CPCV is also available in the bendable version CPCVF, provided with a special cutout that allows to bend the profile with a radius up to 1 meter.

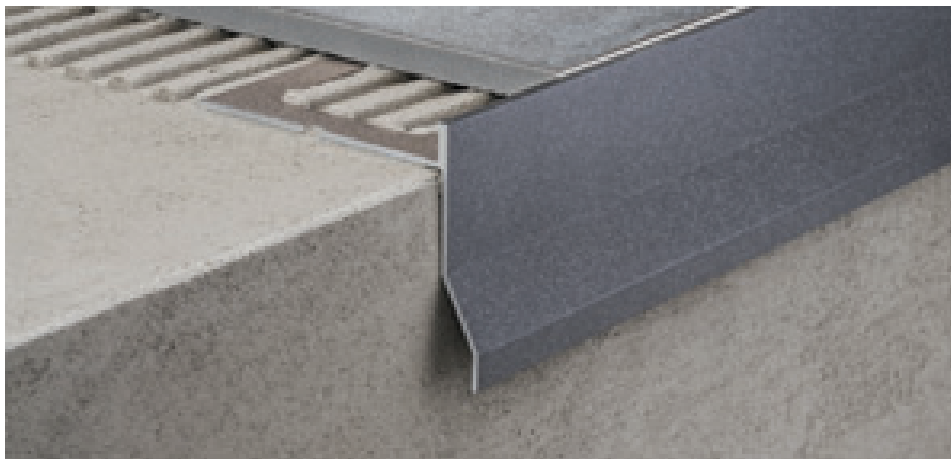

CPCV/55/10 ancient grey colour-coated aluminium

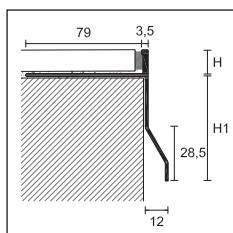

CPCV/



PROTEC

length = 270 cm - pack 5 pcs

| ART. | H | | | | | | | | | |
|--------------------------------|----------|-------|-------|----------|-------|-------|----------|-------|-------|-------|
| | 10 | | | 12,5 | | | 21 | | | |
| finishing | CPCV/55/ | | | CPCV/75/ | | | CPCV/95/ | | | |
| COLOUR-COATED ALUMINIUM | | | | | | | | | | |
| white RAL 9003 | | 87677 | 87678 | - | 87687 | 87688 | - | 87697 | 87698 | - |
| ash grey RAL 7038 | | 87681 | 87682 | 87660 | 87691 | 87692 | 87661 | 87701 | 87702 | 87662 |
| ash grey RAL 7038 embossed | | 87713 | 87714 | - | 87715 | 87716 | - | 87717 | 87718 | - |
| dark brown RAL 8019 | | 87683 | 87684 | - | 87693 | 87694 | - | 87703 | 87704 | - |
| rust | | 87616 | 87617 | - | 87618 | 87619 | - | - | - | - |
| metal grey RAL 9006 | | 87720 | 87721 | - | 87723 | 87724 | - | 87726 | 87727 | - |
| aluminium grey RAL 9007 | | 87750 | 87751 | - | 87753 | 87754 | - | 87756 | 87757 | - |
| ancient grey | | 87707 | 87708 | - | 87709 | 87710 | - | 87711 | 87712 | - |
| euro/m | | | | | | | | | | |

For colours on request please contact our sales department

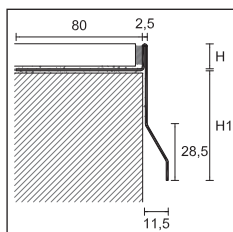

CPCI/

PROTEC

length = 270 cm - pack 5 pcs

| ART. | H | | | | | | | | | |
|--|----------|-------|----------|---|----------|-------|---|-------|-------|---|
| | 10 | | 12,5 | | 21 | | | | | |
| finishing | CPCI/55/ | | CPCI/75/ | | CPCI/95/ | | | | | |
| STAINLESS STEEL | | | | | | | | | | |
| polished stainless steel AISI 304 DIN 1.4301 | | 87671 | 87672 | - | 87673 | 87674 | - | 87675 | 87676 | - |
| euro/m | | | | | | | | | | |

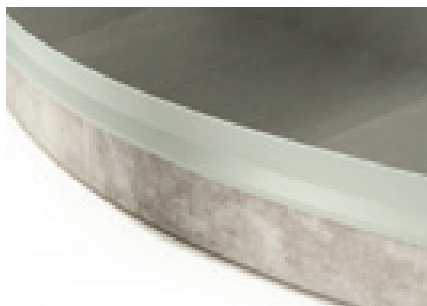

CPCVF/55/10 ash grey RAL 7038 embossed colour-coated aluminium

PROTEC FLEX FLEX LINE

length = 270 cm - pack 2 pcs

| ART. | H | | |
|--------------------------------|-----------|-------|-------|
| | 10 | 12,5 | |
| finishing | CPCVF/55/ | | |
| COLOUR-COATED ALUMINIUM | | | |
| ash grey RAL 7038 | | 87790 | - |
| ash grey RAL 7038 embossed | | 87791 | 87793 |
| ancient grey | | 87792 | 87794 |
| euro/m | | | |

no partial packaging

For colours on request and other heights please contact our sales department

Complete the article code with H measure (for example CPCV/55/ for H=10 becomes CPCV/55/10)

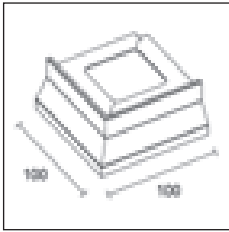

CPCV//E
CPCI//E

90° OUTSIDE CORNER

| pack 5 pcs | | H | | | | | | | | |
|--------------------------------|-----------|-------------|-------|-------|-------------|-------|-------|-------------|-------|-------|
| | | 10 | 12,5 | 21 | 10 | 12,5 | 21 | 10 | 12,5 | 21 |
| ART. | finishing | CPCV/55/ /E | | | CPCV/75/ /E | | | CPCV/95/ /E | | |
| COLOUR-COATED ALUMINIUM | | | | | | | | | | |
| white RAL 9003 | | 87817 | 87818 | - | 87827 | 87828 | - | 87837 | 87838 | - |
| ash grey RAL 7038 | | 87821 | 87822 | 87663 | 87831 | 87832 | 87664 | 87841 | 87842 | 87665 |
| ash grey RAL 7038 embossed | | 87894 | 87895 | - | 87896 | 87897 | - | 87898 | 87899 | - |
| dark brown RAL 8019 | | 87825 | 87826 | - | 87835 | 87836 | - | 87845 | 87846 | - |
| rust | | 87620 | 87621 | - | 87622 | 87623 | - | - | - | - |
| metal grey RAL 9006 | | 87730 | 87731 | - | 87733 | 87734 | - | 87736 | 87737 | - |
| aluminium grey RAL 9007 | | 87760 | 87761 | - | 87763 | 87764 | - | 87766 | 87767 | - |
| ancient grey | | 87877 | 87878 | - | 87879 | 87880 | - | 87881 | 87882 | - |
| euro/pc | | | | | | | | | | |

90° OUTSIDE CORNER

| pack 5 pcs | | H | | | | | | | | |
|--|-----------|-------------|-------|-------------|-------|-------------|------|-------|-------|---|
| | | 10 | 12,5 | 10 | 12,5 | 10 | 12,5 | | | |
| ART. | finishing | CPCI/55/ /E | | CPCI/75/ /E | | CPCI/95/ /E | | | | |
| STAINLESS STEEL | | | | | | | | | | |
| polished stainless steel AISI 304 DIN 1.4301 | | 87801 | 87802 | - | 87803 | 87804 | - | 87805 | 87806 | - |
| euro/pc | | | | | | | | | | |

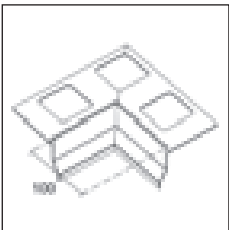

CPCV/55/ /I

90° INSIDE CORNER

| pack 5 pcs | | H | | | | | |
|--------------------------------|-----------|-------------|-------|---|--|--|--|
| | | 10 | 12,5 | | | | |
| ART. | finishing | CPCV/55/ /I | | | | | |
| COLOUR-COATED ALUMINIUM | | | | | | | |
| ash grey RAL 7038 | | 87890 | 87891 | - | | | |
| ash grey RAL 7038 embossed | | 87807 | 87808 | - | | | |
| ancient grey | | 87892 | 87893 | - | | | |
| euro/pc | | | | | | | |

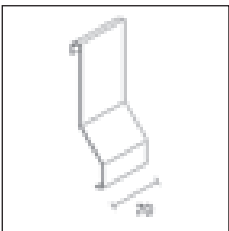

CPCV// /G
CPCI// /G

JUNCTION

| width = 70 mm - pack 5 pcs | | H | | | | | | | | |
|--------------------------------|-----------|-------------|-------|-------|-------------|-------|-------|-------------|-------|-------|
| | | 10 | 12,5 | 21 | 10 | 12,5 | 21 | 10 | 12,5 | 21 |
| ART. | finishing | CPCV/55/ /G | | | CPCV/75/ /G | | | CPCV/95/ /G | | |
| COLOUR-COATED ALUMINIUM | | | | | | | | | | |
| white RAL 9003 | | 87847 | 87848 | - | 87857 | 87858 | - | 87867 | 87868 | - |
| ash grey RAL 7038 | | 87851 | 87852 | 87666 | 87861 | 87862 | 87667 | 87871 | 87872 | 87668 |
| ash grey RAL 7038 embossed | | 87748 | 87749 | - | 87758 | 87759 | - | 87768 | 87769 | - |
| dark brown RAL 8019 | | 87853 | 87854 | - | 87863 | 87864 | - | 87873 | 87874 | - |
| rust | | 87624 | 87625 | - | 87626 | 87627 | - | - | - | - |
| metal grey RAL 9006 | | 87740 | 87741 | - | 87743 | 87744 | - | 87746 | 87747 | - |
| aluminium grey RAL 9007 | | 87770 | 87771 | - | 87773 | 87774 | - | 87776 | 87777 | - |
| ancient grey | | 87883 | 87884 | - | 87885 | 87886 | - | 87887 | 87888 | - |
| euro/pc | | | | | | | | | | |

no partial packaging

JUNCTION

| width = 70 mm - pack 5 pcs | | H | | | | | | | | |
|--|-----------|-------------|-------|-------------|-------|-------------|------|-------|-------|---|
| | | 10 | 12,5 | 10 | 12,5 | 10 | 12,5 | | | |
| ART. | finishing | CPCI/55/ /G | | CPCI/75/ /G | | CPCI/95/ /G | | | | |
| STAINLESS STEEL | | | | | | | | | | |
| polished stainless steel AISI 304 DIN 1.4301 | | 87811 | 87812 | - | 87813 | 87814 | - | 87815 | 87816 | - |
| euro/pc | | | | | | | | | | |

no partial packaging



CPCV/55/E + CPCV/55/G ancient grey colour-coated aluminium

Protec CPCV/30/ is the solution for old terraces. The reduced dimensions of the protruding section allow to avoid removing the perimetral balustrades in case of refurbishment.



CPCV/30/ ancient grey colour-coated aluminium

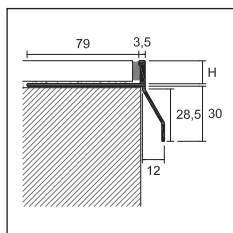

CPCV/30/



PROTEC

length = 270 cm - pack 5 pcs

| | | H | |
|--------------------------------|--|-------------------|-------------------|
| | | 10 | 12,5 |
| ART. | | CPCV/30/10 | CPCV/30/12 |
| finishing | | | |
| COLOUR-COATED ALUMINIUM | | | |
| ash grey RAL 7038 | | 87651 | 87652 |
| ash grey RAL 7038 embossed | | 87655 | 87656 |
| ancient grey | | 87653 | 87654 |
| euro/m | | | |

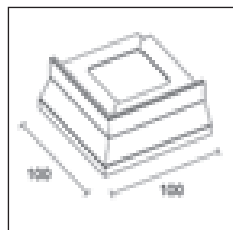

CPCV/30/ / E

90° OUTSIDE CORNER

pack 5 pcs

| | | H | |
|--------------------------------|------------------|---------------------|---------------------|
| | | 10 | 12,5 |
| ART. | finishing | CPCV/30/10/E | CPCV/30/12/E |
| COLOUR-COATED ALUMINIUM | | | |
| ash grey RAL 7038 | | 87780 | 87781 |
| ash grey RAL 7038 embossed | | 87784 | 87785 |
| ancient grey | | 87782 | 87783 |
| euro/pc | | | |

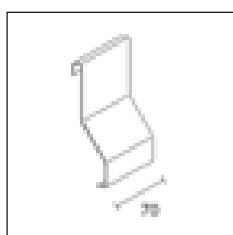

CPCV/30/ /G

JUNCTION

width = 70 mm - pack 5 pcs

| | | H | |
|--------------------------------|------------------|---------------------|---------------------|
| | | 10 | 12,5 |
| ART. | finishing | CPCV/30/10/G | CPCV/30/12/G |
| COLOUR-COATED ALUMINIUM | | | |
| ash grey RAL 7038 | | 87631 | 87632 |
| ash grey RAL 7038 embossed | | 87635 | 87636 |
| ancient grey | | 87633 | 87634 |
| euro/pc | | | |

no partial packaging

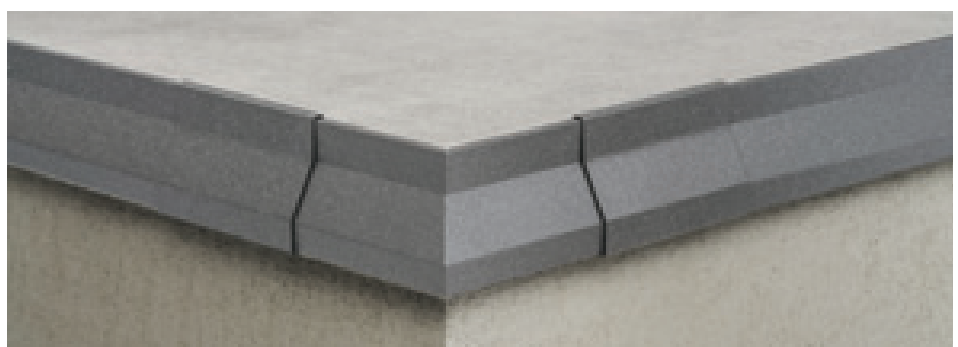

CPCV/30/ /E ancient grey colour-coated aluminium

Complete the article code with H measure (for example CPCV/30/ for H=10 becomes CPCV/30/10)

Protec CPCVD/30/ is a draining perimeter profile, provided with a visible part that facilitates the outflow of rainwater from the tiled surface and an underlying protruding part equipped with holes for a further discharge of the water seeped under the tiles. The reduced dimensions of the visible part allow to avoid removing the perimetral balustrades in case of refurbishment.



CPCVD/30/10 ash grey RAL 7038 embossed colour-coated aluminium

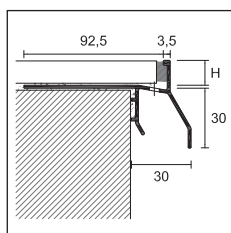

CPCVD/30/



PROTEC

length = 270 cm - pack 5 pcs

| | | H | |
|--------------------------------|--|--------------------|--------------------|
| | | 10 | 12,5 |
| ART. | | CPCVD/30/10 | CPCVD/30/12 |
| finishing | | | |
| COLOUR-COATED ALUMINIUM | | | |
| ash grey RAL 7038 | | 87613 | 87628 |
| ash grey RAL 7038 embossed | | 87614 | 87629 |
| ancient grey | | 87615 | 87630 |
| euro/m | | | |

NEW

90° OUTSIDE CORNER

pack 5 pcs

| | | H | |
|--------------------------------|------------------|----------------------|----------------------|
| | | 10 | 12,5 |
| ART. | finishing | CPCVD/30/10/E | CPCVD/30/12/E |
| COLOUR-COATED ALUMINIUM | | | |
| ash grey RAL 7038 | | 87645 | 87648 |
| ash grey RAL 7038 embossed | | 87646 | 87649 |
| ancient grey | | 87647 | 87650 |
| euro/pc | | | |

NEW

JUNCTION

width = 70 mm - pack 5 pcs

| | | H | |
|--------------------------------|------------------|----------------------|----------------------|
| | | 10 | 12,5 |
| ART. | finishing | CPCVD/30/10/G | CPCVD/30/12/G |
| COLOUR-COATED ALUMINIUM | | | |
| ash grey RAL 7038 | | 87657 | 87669 |
| ash grey RAL 7038 embossed | | 87658 | 87670 |
| ancient grey | | 87659 | 87719 |
| euro/pc | | | |

no partial packaging

white RAL 9003, dark brown RAL 8019, rust, metal grey RAL 9006 and aluminium grey RAL 9007 with a minimum of 270 meters, on request, without surcharge.

For colours on request please contact our sales department.

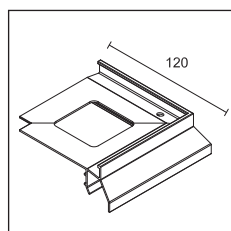

CPCVD/30/ E

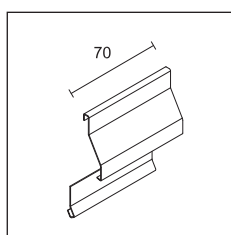

CPCVD/30/ G

Complete the article code with H measure (for example CPCVD/30/ for H=10 becomes CPCVD/30/10)

Protec CPGV is a perimetral profile for the protection and finishing of the outside edges of terraces and balconies. This profile is composed of a vertical part that facilitates the outflow of rainwater from the tiled surface and protects the border of the floor, and a sloping part equipped with holes for a further discharge of the water seeped under the tiles. This technical solution and the consequent drainage reduce the problems of freezing and thawing and the unsightly efflorescences on the tiles grouts. It can be used with tiles thicknesses up to 12,5 mm.



CPGV/55/10 ancient grey colour-coated aluminium

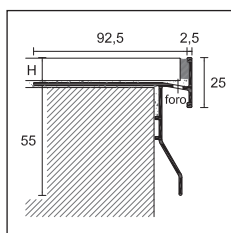

CPGV/55/



PROTEC

length = 270 cm - pack 5 pcs

| | | H | |
|--------------------------------|----------------------------|------------|------------|
| | | 10 | 12,5 |
| ART. | finishing | CPGV/55/10 | CPGV/55/12 |
| COLOUR-COATED ALUMINIUM | | | |
| | ash grey RAL 7038 | 87580 | 87581 |
| | ash grey RAL 7038 embossed | 87578 | 87579 |
| | metal grey RAL 9006 | 87590 | 87591 |
| | ancient grey | 87582 | 87583 |
| | white stone | 87547 | 87548 |
| <i>euro/m</i> | | | |

white RAL 9003, dark brown RAL 8019 and aluminium grey RAL 9007 with a minimum of 270 meters, on request, without surcharge. For colours on request please contact our sales department.

90° OUTSIDE CORNER

pack 5 pcs

| | | H | |
|--------------------------------|----------------------------|--------------|--------------|
| | | 10 | 12,5 |
| ART. | finishing | CPGV/55/10/E | CPGV/55/12/E |
| COLOUR-COATED ALUMINIUM | | | |
| | ash grey RAL 7038 | 87584 | 87585 |
| | ash grey RAL 7038 embossed | 87595 | 87596 |
| | metal grey RAL 9006 | 87592 | 87593 |
| | ancient grey | 87586 | 87587 |
| | white stone | 87536 | 87537 |
| <i>euro/pc</i> | | | |

90° INSIDE CORNER

pack 5 pcs

| | | H | |
|--------------------------------|--------------|--------------|--------------|
| | | 10 | 12,5 |
| ART. | finishing | CPGV/55/10/I | CPGV/55/12/I |
| COLOUR-COATED ALUMINIUM | | | |
| | ancient grey | 87566 | 87567 |
| | white stone | 87538 | 87539 |
| <i>euro/pc</i> | | | |

JUNCTION

width = 70 mm - pack 5 pcs

| | | H | |
|--------------------------------|----------------------------|--------------|--------------|
| | | 10 | 12,5 |
| ART. | finishing | CPGV/55/10/G | CPGV/55/12/G |
| COLOUR-COATED ALUMINIUM | | | |
| | ash grey RAL 7038 | 87610 | 87610 |
| | ash grey RAL 7038 embossed | 87612 | 87612 |
| | metal grey RAL 9006 | 87594 | 87594 |
| | ancient grey | 87611 | 87611 |
| | white stone | 87528 | 87528 |
| <i>euro/pc</i> | | | |

no partial packaging

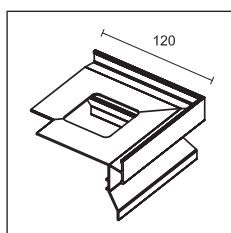

CPGV/55/ /E

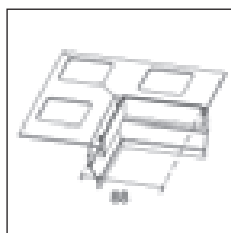

CPGV/55/ /I

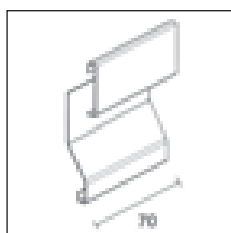

CPGV/55/ /G

Protec CPQV is a perimetral profile for the protection and finishing of the outside edges of terraces and balconies. This profile is composed of a vertical part that covers the border of the floor and facilitates the outflow of rainwater from the tiled surface, and a sloping part equipped with holes for a further discharge of the water seeped under the tiles. This technical solution and the consequent drainage reduce the problems of freezing and thawing and the unsightly efflorescences on the tiles grouts. It can be used with tiles thicknesses up to 12,5 mm.

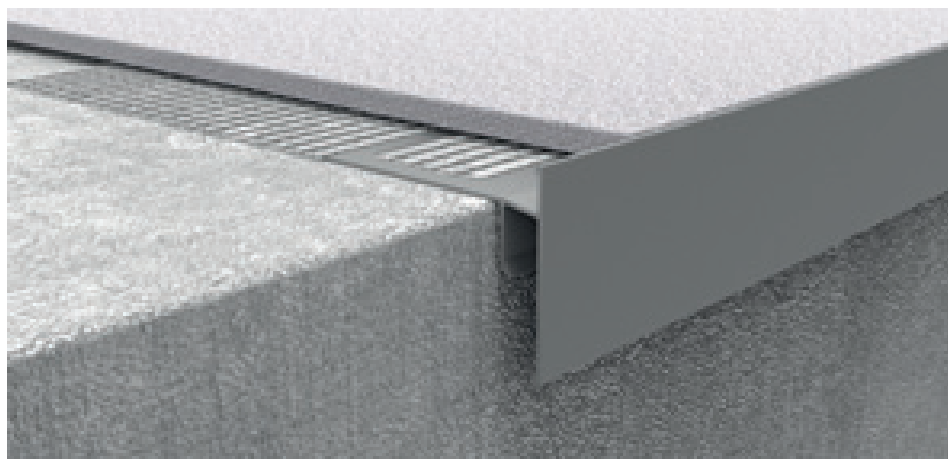

CPQV/50/10 ash grey RAL 7038 embossed colour-coated aluminium

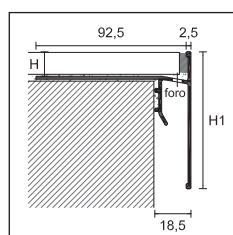

CPQV

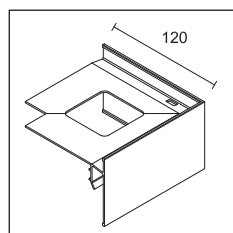

CPQV//E

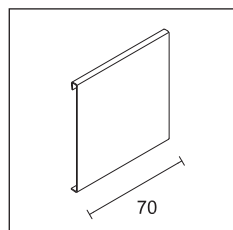

CPQV//G



CPQV ash grey RAL 7038

PROTEC

length = 270 cm - pack 5 pcs

| | | H | | | |
|--------------------------------|----------------------------|------------------|-------|------------------|-------|
| | | 10 | 12,5 | 10 | 12,5 |
| ART. | finishing | CPQV/50/ (H1=50) | | CPQV/70/ (H1=70) | |
| COLOUR-COATED ALUMINIUM | | | | | |
| | ash grey RAL 7038 | 86960 | 86961 | 86962 | 86963 |
| | ash grey RAL 7038 embossed | 86964 | 86965 | 86966 | 86967 |
| | metal grey RAL 9006 | 86968 | 86969 | 86970 | 86971 |
| | ancient grey | 86972 | 86973 | 86974 | 86975 |
| | white stone | 86976 | 86977 | 86978 | 86979 |
| euro/m | | | | | |

white RAL 9003, dark brown RAL 8019 and aluminium grey RAL 9007 with a minimum of 270 meters, on request, without surcharge. For colours on request please contact our sales department.

90° OUTSIDE CORNER

pack 5 pcs

| | | H | | | |
|--------------------------------|----------------------------|-------------|-------|-------------|-------|
| | | 10 | 12,5 | 10 | 12,5 |
| ART. | finishing | CPQV/50/ /E | | CPQV/70/ /E | |
| COLOUR-COATED ALUMINIUM | | | | | |
| | ash grey RAL 7038 | 86980 | 86981 | 86982 | 86983 |
| | ash grey RAL 7038 embossed | 86984 | 86985 | 86986 | 86987 |
| | metal grey RAL 9006 | 86988 | 86989 | 86990 | 86991 |
| | ancient grey | 86992 | 86993 | 86994 | 86995 |
| | white stone | 86996 | 86997 | 86998 | 86999 |
| euro/pc | | | | | |

JUNCTION

width = 70 mm - pack 5 pcs

| | | H | |
|--------------------------------|----------------------------|-----------|-----------|
| ART. | finishing | CPQV/50/G | CPQV/70/G |
| COLOUR-COATED ALUMINIUM | | | |
| | ash grey RAL 7038 | 87000 | 87001 |
| | ash grey RAL 7038 embossed | 87002 | 87003 |
| | metal grey RAL 9006 | 87004 | 87005 |
| | ancient grey | 87006 | 87007 |
| | white stone | 87008 | 87009 |
| euro/pc | | | |

no partial packaging

Complete the article code with H measure (for example CPQV/50/ for H=12,5 becomes CPQV/50/12)

Protec CPEV and CPEI are a series of edge reversible profiles for the protection and finishing of the outside edges of terraces and balconies.

Available in stainless steel and colour-coated aluminium, they can be installed flush with the border or detached from it. They can be used with tiles or marble thicknesses from 11 to 32 mm.

The particular section is recommended to protect the stair nosing and sidewalk edge, hiding the connection between tread and riser.

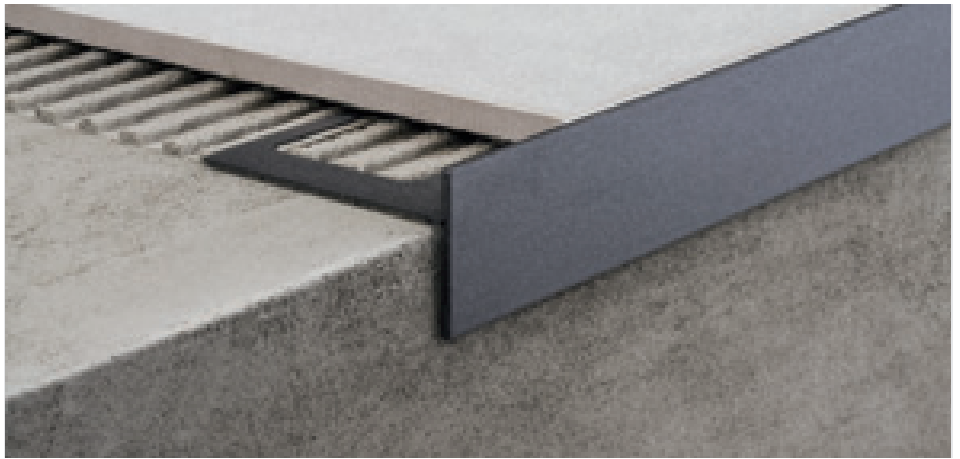

CPEV/45/12 ancient grey colour-coated aluminium

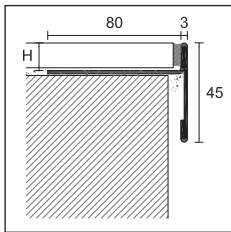

CPEV/45/

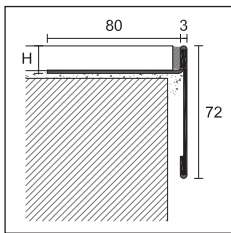

CPEV/72/

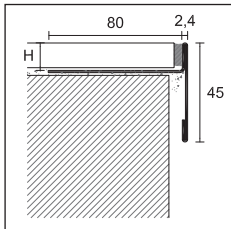

CPEI/



PROTEC

length = 270 cm - pack 5 pcs

| | | H | | | | |
|--|--|----|------|----|----|------|
| | | 11 | 12,5 | 15 | 20 | 12,5 |

| ART. | CPEV/45/ | | | | CPEV/72/ |
|------------------|----------|--|--|--|----------|
| finishing | | | | | |

COLOUR-COATED ALUMINIUM

| | | | | | | |
|---------------------|--|-------|-------|-------|-------|-------|
| ash grey RAL 7038 |  | 87530 | 87550 | 87551 | 87552 | 87252 |
| metal grey RAL 9006 |  | 87531 | 87540 | 87541 | 87542 | - |
| ancient grey |  | 87532 | 87553 | 87554 | 87555 | - |

euro/m

for CPEV/72 white RAL 9003, dark brown RAL 8019, metal grey RAL 9006, aluminium grey RAL 9007, ancient grey, ash grey RAL 7038 embossed and rust with minimum 270 meters, on request, without surcharge. For different colours, please contact our Sales Department. For CPEV/45 white RAL 9003, dark brown RAL 8019, aluminium grey RAL 9007, ash grey RAL 7038 embossed and rust with minimum 270 meters, on request, without surcharge. For colours on request please contact our sales department.

PROTEC

length = 270 cm - pack 10 pcs

| | | H | | |
|--|--|------|----|----|
| | | 12,5 | 15 | 20 |

| ART. | CPEI/45/ | | |
|------|----------|--|--|
|------|----------|--|--|

STAINLESS STEEL

| | | | | | |
|---|---|---|-------|-------|-------|
| polished stainless steel AISI 304 DIN 1.4301 |  | - | 87570 | 87571 | 87572 |
|---|---|---|-------|-------|-------|

euro/m

Complete the article code with H measure
(for example CPEV/45/ for H=12,5 becomes
CPEV/45/12)

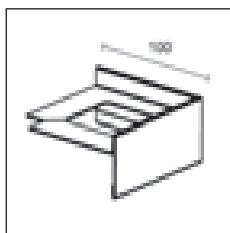

CPEV// /E
CPEI// /E

90° OUTSIDE CORNER

| pack 5 pcs | | H | | | | |
|--------------------------------|--|--------------------|-------|-------|-------|--------------------|
| | | 11 | 12,5 | 15 | 20 | 12,5 |
| ART. | | CPEV/45/ /E | | | | CPEV/72/ /E |
| finishing | | | | | | |
| COLOUR-COATED ALUMINIUM | | | | | | |
| ash grey RAL 7038 | | 87533 | 87556 | 87557 | 87558 | 87255 |
| metal grey RAL 9006 | | 87534 | 87543 | 87544 | 87545 | - |
| ancient grey | | 87535 | 87559 | 87560 | 87561 | - |
| euro/pc | | | | | | |

90° OUTSIDE CORNER

| pack 5 pcs | | H | | | |
|---|--|--------------------|-------|-------|-------|
| | | 12,5 | 15 | 20 | |
| ART. | | CPEI/45/ /E | | | |
| STAINLESS STEEL | | | | | |
| polished stainless steel AISI 304 DIN 1.4301 | | - | 87573 | 87574 | 87575 |
| euro/pc | | | | | |

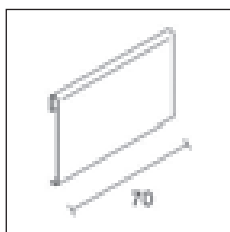

CPEV// /G
CPEI// /G

JUNCTION

| width = 70 mm - pack 5 pcs | | H | | | | |
|--------------------------------|--|--------------------|-------|-------|-------|--------------------|
| | | 11 | 12,5 | 15 | 20 | 12,5 |
| ART. | | CPEV/45/ /G | | | | CPEV/72/ /G |
| finishing | | | | | | |
| COLOUR-COATED ALUMINIUM | | | | | | |
| ash grey RAL 7038 | | 87562 | 87562 | 87562 | 87562 | 87258 |
| metal grey RAL 9006 | | 87546 | 87546 | 87546 | 87546 | - |
| ancient grey | | 87563 | 87563 | 87563 | 87563 | - |
| euro/pc | | | | | | |

no partial packaging

JUNCTION

| width = 70 mm - pack 5 pcs | | H | | | |
|---|--|--------------------|-------|-------|-------|
| | | 12,5 | 15 | 20 | |
| ART. | | CPEI/45/ /G | | | |
| STAINLESS STEEL | | | | | |
| polished stainless steel AISI 304 DIN 1.4301 | | - | 87576 | 87576 | 87576 |
| euro/pc | | | | | |

no partial packaging



CPEV/45/12/E + CPEV/45/12/G ancient grey colour-coated aluminium

Complete the article code with H measure
(for example CPEV/45/ for H=12,5 becomes
CPEV/45/12)

cerfix® protec

Protec CPNV is a series of edge profiles for the protection and the finishing of the outside edges of terraces and balconies. Available in colour-coated aluminium, they can be installed flush with the border or detached from it. Their special section makes them suitable for the protection of the borders of steps or sidewalks, since it hides the junction between the tread and the riser.

Protec CPNV is also available in the bendable version CPNVF, provided with a special cutout that allows to bend the profile with a radius up to 40 cm.



CPNV/45/ ash grey RAL 7038 embossed colour-coated aluminium

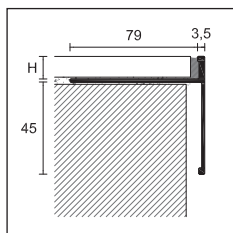

CPNV/45/



PROTEC

length = 270 cm - pack 5 pcs

| ART. | finishing | 10 | 11 | 12,5 | NEW 21 |
|------|-----------|----|----|------|--------|
|------|-----------|----|----|------|--------|

COLOUR-COATED ALUMINIUM

| CPNV/45/ | ash grey | 87270 | 87271 | 87272 | 87292 |
|----------|-------------------|-------|-------|-------|-------|
| | RAL 7038 embossed | | | | |
| | ancient grey | 87273 | 87274 | 87275 | 87293 |

euro/m

white RAL 9003, dark brown RAL 8019, metal grey RAL 9006, aluminium grey RAL 9007, ash grey RAL 7038 and rust with a minimum of 270 meters, on request, without surcharge. For colours on request please contact our sales department.

90° OUTSIDE CORNER

pack 5 pcs

| ART. | finishing | 10 | 11 | 12,5 | NEW 21 |
|------|-----------|----|----|------|--------|
|------|-----------|----|----|------|--------|

COLOUR-COATED ALUMINIUM

| CPNV/45/ /E | ash grey | 87276 | 87277 | 87278 | 87294 |
|-------------|-------------------|-------|-------|-------|-------|
| | RAL 7038 embossed | | | | |
| | ancient grey | 87279 | 87280 | 87281 | 87295 |

euro/pc

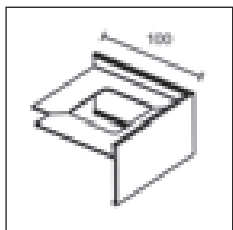

CPNV/45/ /E

JUNCTION

width = 70 mm - pack 5 pcs

| ART. | finishing | 10 | 11 | 12,5 | NEW 21 |
|------|-----------|----|----|------|--------|
|------|-----------|----|----|------|--------|

COLOUR-COATED ALUMINIUM

| CPNV/45/ /G | ash grey | 87282 | 87283 | 87284 | 87296 |
|-------------|-------------------|-------|-------|-------|-------|
| | RAL 7038 embossed | | | | |
| | ancient grey | 87285 | 87286 | 87287 | 87297 |

euro/pc

no partial packaging

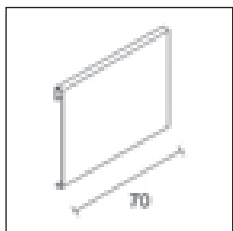

CPNV/45/ /G

PROTEC FLEX FLEX LINE

length = 270 cm - pack 2 pcs

| ART. | finishing | 10 | 12,5 |
|------|-----------|----|------|
|------|-----------|----|------|

| ART. | finishing | CPNVF/45/ | | |
|------|-----------|-----------|--|--|
|------|-----------|-----------|--|--|

COLOUR-COATED ALUMINIUM

| | | | |
|-------------------|--|-------|-------|
| ash grey | | 87288 | 87290 |
| RAL 7038 embossed | | | |
| ancient grey | | 87289 | 87291 |

euro/m

no partial packaging

For colours on request and other heights please contact our sales department.



CPNVF/45/10 ancient grey colour-coated aluminium

Complete the article code with H measure (for example CPNV/45/ for H=10 becomes CPNV/45/10)

Protec CPBV is a series of edge profiles for the protection and the finishing of the outside edges of terraces and balconies. Available in colour-coated aluminium, they have been designed with a protruding section. In addition to protecting and finishing the outside edges, they guarantee the outflow of water from the floor, avoiding the contact with the outside border. They can be installed with tiles or marble of any thickness.



CPBV/55 ash grey RAL 7038 colour-coated aluminium

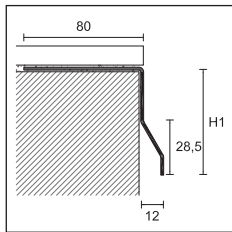

CPBV/

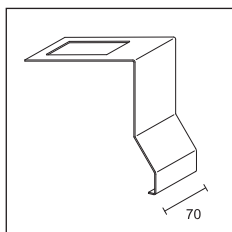
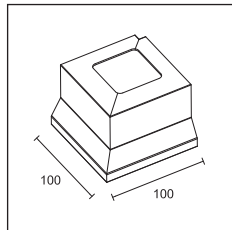



PROTEC

length = 270 cm - pack 5 pcs

| ART. | finishing | 55 | 75 | 95 |
|------|-----------|----|----|----|
|------|-----------|----|----|----|

COLOUR-COATED ALUMINIUM

| | | | | | |
|---------------|-------------------|---|-------|-------|-------|
| CPBV/ | ash grey RAL 7038 |  | 87332 | 87334 | 87336 |
| | ancient grey |  | 87333 | 87335 | 87337 |
| <i>euro/m</i> | | | | | |



white RAL 9003, dark brown RAL 8019, rust, metal grey RAL 9006 and aluminium grey RAL 9007 with a minimum of 270 meters, on request, without surcharge.
For colours on request please contact our sales department.

90° OUTSIDE CORNER

pack 5 pcs

| ART. | finishing | 55 | 75 | 95 |
|------|-----------|----|----|----|
|------|-----------|----|----|----|

COLOUR-COATED ALUMINIUM



| | | | | | |
|----------------|-------------------|---|-------|-------|-------|
| CPBV/ /E | ash grey RAL 7038 |  | 87402 | 87404 | 87406 |
| | ancient grey |  | 87403 | 87405 | 87407 |
| <i>euro/pc</i> | | | | | |

JUNCTION

width = 70 mm - pack 5 pcs

| ART. | finishing | 55 | 75 | 95 |
|------|-----------|----|----|----|
|------|-----------|----|----|----|

COLOUR-COATED ALUMINIUM

| | | | | | |
|----------------|-------------------|---|-------|-------|-------|
| CPBV/ /G | ash grey RAL 7038 |  | 87462 | 87464 | 87466 |
| | ancient grey |  | 87463 | 87465 | 87467 |
| <i>euro/pc</i> | | | | | |

no partial packaging



CPBV/55/E + CPBV/55/G ash grey RAL 7038 colour-coated aluminium

Complete the article code with H1 measure (for example CPBV/ for H1=55 becomes CPBV/55)

cerfix® protec

Protec CPHA - CPHV is an edge profile in anodised and colour-coated aluminium for terraces, balconies and sidewalks. The shape allows the outflow of water, avoiding the direct contact with the screed. Installed along the perimeter, it allows to outline the ceramic tiles and to protect the border in many fields of use. It can be used with tiles thicknesses up to 21 mm.

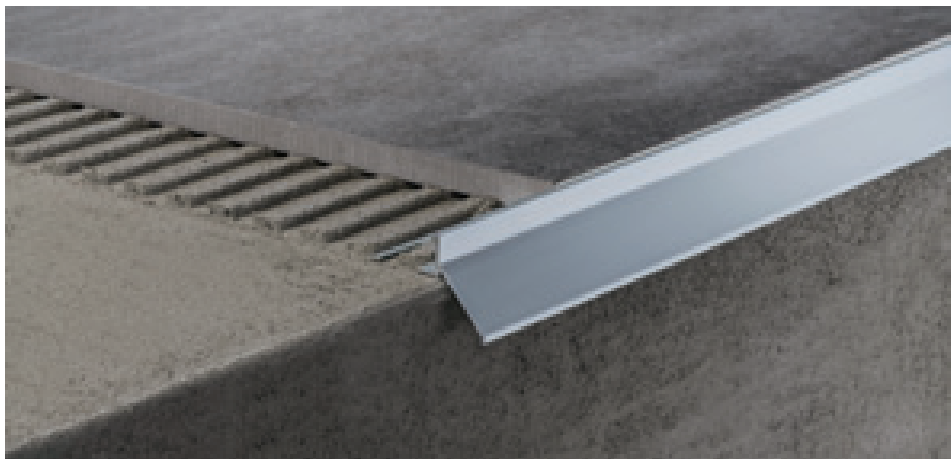

CPHA/10 silver anodised aluminium

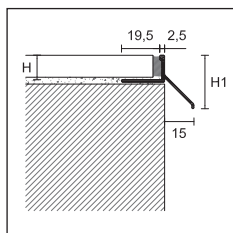

CPHA/
CPHV/



PROTEC

length = 270 cm - pack 10 pcs

| | | H (H1) | | | |
|------|-----------|--------|---------|-----------|---------|
| ART. | finishing | 8 (23) | 10 (25) | 12,5 (27) | 21 (36) |

ALUMINIUM

| | | | | | | |
|-------|-----------------|--|---------------|-------|-------|-------|
| CPHA/ | silver anodised | | 87599 | 87600 | 87601 | 87602 |
| | | | <i>euro/m</i> | | | |

COLOUR-COATED ALUMINIUM

| | | | | | | |
|-------|----------------------------|--|---------------|-------|-------|-------|
| CPHV/ | ash grey RAL 7038 | | - | 87606 | 87607 | 87608 |
| | ash grey RAL 7038 embossed | | - | 87637 | 87638 | - |
| | ancient grey | | - | 87639 | 87640 | - |
| | | | <i>euro/m</i> | | | |

white RAL 9003, dark brown RAL 8019, metal grey RAL 9006, aluminium grey RAL 9007 and ancient grey with a minimum of 270 meters, on request, without surcharge. For colours on request please contact our sales department.

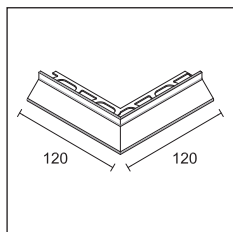

CPHA/ E
CPHV/ E

90° OUTSIDE CORNER

dimension = 12x12 cm - pack 5 pcs

| | | H (H1) | | | |
|------|-----------|--------|---------|-----------|---------|
| ART. | finishing | 8 (23) | 10 (25) | 12,5 (27) | 21 (36) |

ALUMINIUM

| | | | | | | |
|---------|-----------------|--|----------------|-------|-------|-------|
| CPHA/ E | silver anodised | | 87564 | 87565 | 87597 | 87598 |
| | | | <i>euro/pc</i> | | | |

COLOUR-COATED ALUMINIUM

| | | | | | | |
|---------|----------------------------|--|----------------|-------|-------|-------|
| CPHV/ E | ash grey RAL 7038 | | - | 87603 | 87604 | 87609 |
| | ash grey RAL 7038 embossed | | - | 87641 | 87642 | - |
| | ancient grey | | - | 87643 | 87644 | - |
| | | | <i>euro/pc</i> | | | |



CPHA/ E silver anodised aluminium

Complete the article code with H measure (for example CPHA/ for H=10 becomes CPHA/10)

Protec CPLV is a line of perimetral profiles in colour-coated aluminium, for the protection and finishing of the borders of outdoor raised floors, terraces or balconies. They are composed of a drilled base CPLB to be screwed to the supports, or, as an alternative, a cut base CPLB/2 for glued tiles, and a visible profile to be fixed with adhesive, available in 3 different heights according to the floor thickness. There are also special accessories for the creation of external corners and junctions.



CPLB + CPLV/60 ash grey RAL 7038 colour-coated aluminium

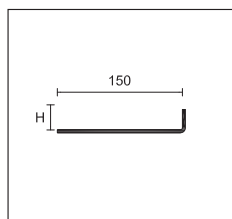
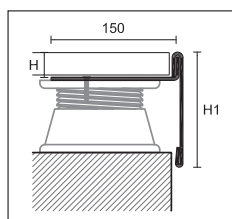

CPLB
base for raised
floors

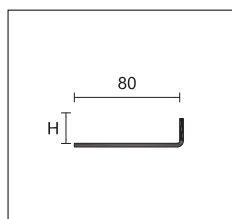

CPLB/2
punched base
for tiled floors

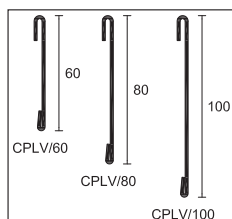

CPLV/

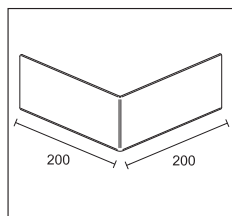

CPLV/ /E

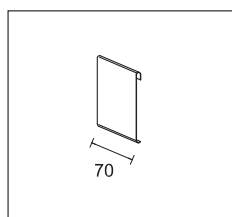

CPLV/ /G

PROTEC

length = 270 cm - pack 10 pcs **H**

BASE

ART. finishing 20

ALUMINIUM

| | | | |
|---------------|-------------------|--|-------|
| CPLB | natural aluminium | | 86900 |
| | <i>euro/m</i> | | |
| CPLB/2 | natural aluminium | | 86901 |
| | <i>euro/m</i> | | |

CPLB with draining holes available on request, extra euro/m
CPLB and CPLB/2 in 15 and 25 mm height available on request
possibility to choose noise-proof rubber PPL/GM, see Catalogue of Supports for raised floors 2024_01

PROTEC

length = 270 cm - pack 10 pcs **H1**

FRONT

ART. finishing 60 80 100

COLOUR-COATED ALUMINIUM

| | | | | | |
|--------------|-------------------|--|-------|-------|-------|
| CPLV/ | ash grey RAL 7038 | | 86902 | 86904 | 86906 |
| | ancient grey | | 86903 | 86905 | 86907 |
| | stone | | 86908 | 86909 | 86910 |
| | greige | | 86911 | 86912 | 86913 |
| | sand | | 86914 | 86915 | 86916 |
| | beige | | 86917 | 86918 | 86919 |
| | <i>euro/m</i> | | | | |

white RAL 9003, dark brown RAL 8019, metal grey RAL 9006, aluminium grey RAL 9007, ash grey RAL 7038 embossed and rust with a minimum of 270 meters, on request, without surcharge. For other colours please contact our sales department.

90° OUTSIDE CORNER

pack 5 pcs **H1**

ART. finishing 60 80 100

COLOUR-COATED ALUMINIUM

| | | | | | |
|-----------------|-------------------|--|-------|-------|-------|
| CPLV/ /E | ash grey RAL 7038 | | 86920 | 86922 | 86924 |
| | ancient grey | | 86921 | 86923 | 86925 |
| | stone | | 86926 | 86927 | 86928 |
| | greige | | 86929 | 86931 | 86933 |
| | sand | | 86935 | 86936 | 86937 |
| | beige | | 86938 | 86939 | 86940 |
| | <i>euro/pc</i> | | | | |

JUNCTION

width = 70 mm - pack 5 pcs **H1**

ART. finishing 60 80 100

COLOUR-COATED ALUMINIUM

| | | | | | |
|-----------------|-------------------|--|-------|-------|-------|
| CPLV/ /G | ash grey RAL 7038 | | 86930 | 86932 | 86934 |
| | ancient grey | | 86941 | 86942 | 86943 |
| | stone | | 86944 | 86945 | 86946 |
| | greige | | 86947 | 86948 | 86949 |
| | sand | | 86950 | 86951 | 86952 |
| | beige | | 86953 | 86954 | 86955 |
| | <i>euro/pc</i> | | | | |

no partial packaging





stair nosing profiles

Protection, finishing and safety. Protect and Prostep are two ranges of stair nosing profiles for stairs for public and private use.

stair nosing profiles

cerfix® prostep

Prostep SGA, SGI, SGN and SGK are profiles for the realization and protection of ceramic, marble and stone steps. Thanks to the rounded section, they give elegance to the steps. The models in chromium-plated brass and anodized aluminium are not recommended in case of intense foot traffic, while those in stainless steel are particularly suitable for heavy foot traffic.



SGI/11 polished stainless steel AISI 304 DIN 1.4301

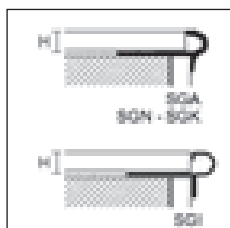

PROSTEP

length = 270 cm - pack 10 pcs

| ART. finishing | | H | | | | |
|------------------------------|--|-------|-------|-------|-------|---|
| | | 7 | 9 | 11 | 13 | |
| ALUMINIUM | | | | | | |
| SGA/ | silver anodised | 94965 | 94966 | 94967 | 94968 | |
| <i>euro/m</i> | | | | | | |
| STAINLESS STEEL | | | | | | |
| SGI/ | polished stainless steel AISI 304 DIN 1.4301 | - | 94922 | 94924 | - | - |
| <i>euro/m</i> | | - | | | - | - |
| BRASS | | | | | | |
| SGN/ | natural brass | 94970 | 94971 | 94972 | - | - |
| <i>euro/m</i> | | | | | | |
| CHROMIUM-PLATED BRASS | | | | | | |
| SGK/ | chromium-plated brass | 94980 | 94981 | 94982 | - | - |
| <i>euro/m</i> | | | | | | |

PPDESIGN

individually packed - art. SGK/9 and SGK/11 pack 5 pcs

Prostep SMA and SM are aluminium and brass profiles for realization and protection of ceramic, marble and stone steps. Thanks to the grooved top part, they are consistent with DIN 51131 law concerning non-slip stair nosing.



SMA/4,5 natural aluminium

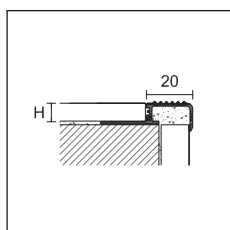

SMA/
SM/

PROSTEP

length= 270 cm - pack 10 pcs

| ART. finishing | | H | | | | |
|------------------|-------------------|-------|-------|-------|-------|-------|
| | | 4,5 | 8 | 10 | 11 | 12,5 |
| ALUMINIUM | | | | | | |
| | natural aluminium | 93967 | 93969 | 93970 | 93979 | 93971 |
| <i>euro/m</i> | | | | | | |
| SMA/ | silver anodised | 93975 | 93976 | 93977 | 93980 | 93978 |
| <i>euro/m</i> | | | | | | |
| BRASS | | | | | | |
| SM/ | natural brass | - | - | 93972 | - | 93973 |
| <i>euro/m</i> | | - | - | | - | |

individually packed

Complete the article code with H measure (for example for SGA/ for H=11 becomes SGA/11)

Protrim IPI/ are minimal profiles in aluminium or stainless steel suitable for the edging of external corners that need the 45 degrees cut. These profiles allow a perfect laying both on coverings and on stairs or platforms in ceramic or wood.



IPA/11 silver anodised aluminium

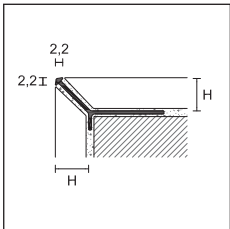

IPA/
IPB/



PROTRIM IP

length = 270 cm - pack 20 pcs

| | | H | | | |
|------------------|------------------------|-------|-------|-------|-------|
| ART. | finishing | 4,5 | 8 | 11 | 15 |
| ALUMINIUM | | | | | |
| IPA/ | silver anodised | 95006 | 95178 | 95181 | 95185 |
| | euro/m | | | | |
| IPB/ | bright polished silver | 95008 | - | - | - |
| | euro/m | | | | |

individually packed

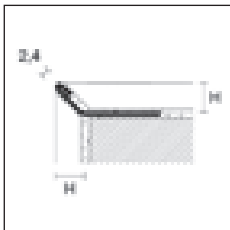

IPI/

PROTRIM IP

length = 270 cm - pack 20 pcs

| | | H | | | |
|------------------------|---------------------------------------|-------|-------|-------|-------|
| ART. | finishing | 7 | 8 | 11 | 12,5 |
| STAINLESS STEEL | | | | | |
| IPI/ | stainless steel AISI 304 - DIN 1.4301 | 95169 | 95170 | 95173 | 95174 |
| | euro/m | | | | |

individually packed

Prostep SNG and SN are aluminium and brass profiles for realization and protection of ceramic, marble and stone steps.



SNG/10 silver anodised aluminium

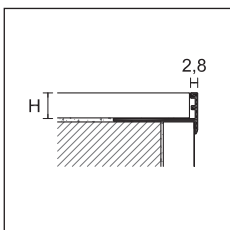

SNG/
SN/



PROSTEP

length = 270 cm - pack 20 pcs

| | | H | | | |
|------------------|-------------------|-------|-------|-------|-------|
| ART. | finishing | 8 | 10 | 12,5 | 15 |
| ALUMINIUM | | | | | |
| | natural aluminium | 90040 | 90042 | 90044 | 90046 |
| | euro/m | | | | |
| SNG/ | silver anodised | 90041 | 90043 | 90045 | 90047 |
| | euro/m | | | | |
| SN/ | natural brass | 93991 | 93992 | 93993 | - |
| | euro/m | | | | |

individually packed - SN/ pack 10 pcs

Complete the article code with H measure (for example IPA/ for H=11 becomes IPA/11)

stair nosing profiles

cerfix® prostep

Prostep SAR and SIR are stair nosing profiles in aluminium and stainless steel, suitable for the protections of steps or pavements. Thanks to the reversible shapes, these two models can be used for tiles of four different thicknesses.



SAR/10/12 silver anodised aluminium



SIR/10/12 stainless steel AISI 304 DIN 1.4301

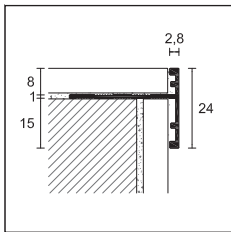

SAR/8

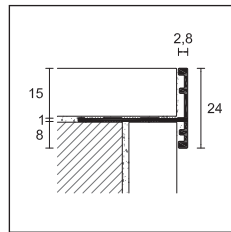

SAR/15

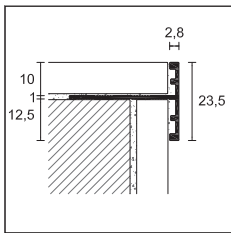

SAR/10

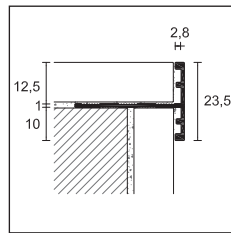

SAR/12

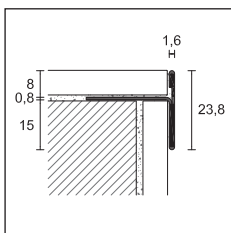

SIR/8
SIRS/8

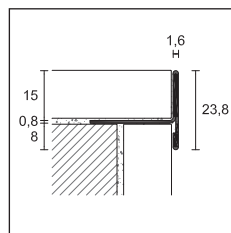

SIR/15
SIRS/15

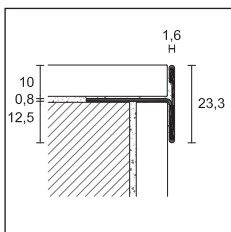

SIR/10
SIRS/10

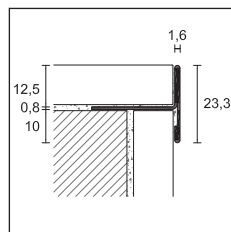

SIR/12
SIRS/12

PROSTEP

length = 270 cm - pack 10 pcs

ART. finishing

ALUMINIUM

| | | | |
|-----------|-----------------|--|-------|
| SAR/8/15 | silver anodised | | 93956 |
| | euro/m | | |
| SAR/10/12 | silver anodised | | 93958 |
| | euro/m | | |

individually packed

PROSTEP

length = 270 cm - pack 10 pcs

ART. finishing

STAINLESS STEEL

| | | | |
|------------|---|--|-------|
| SIR/8/15 | polished stainless steel AISI 304 DIN 1.4301 | | 93952 |
| | euro/m | | |
| SIR/10/12 | polished stainless steel AISI 304 DIN 1.4301 | | 93954 |
| | euro/m | | |
| SIRS/8/15 | brushed stainless steel AISI 304 DIN 1.4301 | | 93953 |
| | euro/m | | |
| SIRS/10/12 | brushed stainless steel AISI 304 DIN 1.4301 | | 93955 |
| | euro/m | | |

individually packed

Prostep SIS is a stainless steel profile for the realization and protection of ceramic, marble and stone steps. Thanks to the brushed and knurled tread, it is compliant with non-slip stair regulation DIN 51131. Prostep SIS is particularly suitable for the protection of steps subject to heavy pedestrian traffic.



SIS/10 brushed stainless steel AISI 304 - DIN 1.4301

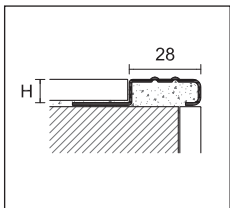

SIS/

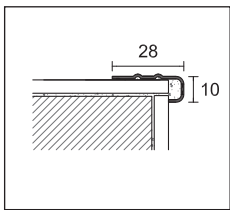

SIS/10/SF



PROSTEP

length = 270 cm - pack 10 pcs H

| ART. | finishing | 10 | 11 | 12,5 |
|------|-----------|----|----|------|
|------|-----------|----|----|------|

STAINLESS STEEL

| | | | | | |
|-----------|---|--|-------|-------|-------|
| SIS/ | brushed stainless steel AISI 304 DIN 1.4301 | | 93987 | 93989 | 93988 |
| | <i>euro/m</i> | | | | |
| SIS/10/SF | brushed stainless steel AISI 304 DIN 1.4301 | | 93997 | - | - |
| | <i>euro/m</i> | | | - | - |

individually packed

Prostep SIX is a stainless steel profile for realization and protection of ceramic, marble and stone steps. They are in accordance with DIN 51131 regulation of non-slip stair nosing thanks to the application of non-slip strips: Safety-Step. It is particularly suitable to protect the stairs in case of high pedestrian traffic.

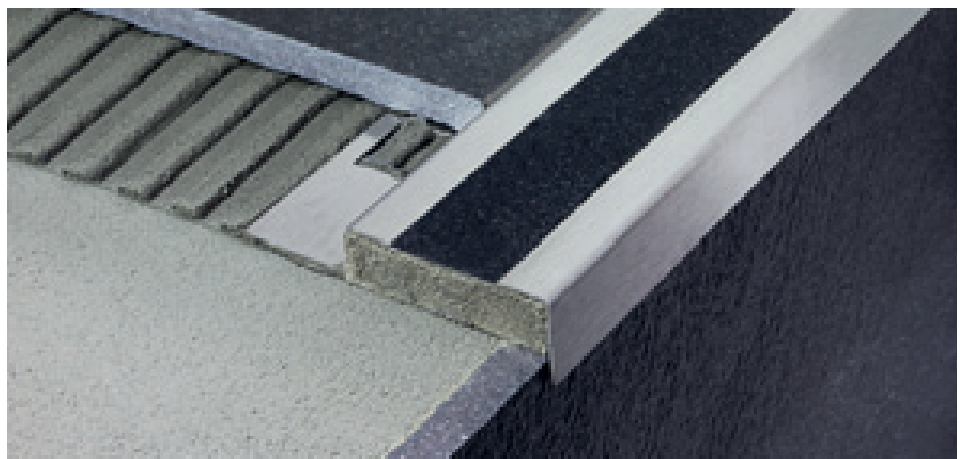

SIX/10 brushed stainless steel AISI 304 - DIN 1.4301 + black slip-resistant 25 mm

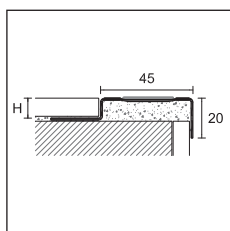

SIX/



PROSTEP

length = 270 cm - pack 10 pcs H

| ART. | finishing | 8 | 10 | 12,5 |
|------|-----------|---|----|------|
|------|-----------|---|----|------|

STAINLESS STEEL

| | | | | | |
|------|--|--|-------|-------|-------|
| SIX/ | brushed stainless steel AISI 304 DIN 1.4301 + black slip-resistant 25 mm | | 93981 | 93982 | 93983 |
| | <i>euro/m</i> | | | | |

individually packed

Complete the article code with H measure (for example SIS/ for H=10 becomes SIS/10)

stair nosing profiles

cerfix® prostep

Prostep SP is a line of profiles in PVC with aluminium base for realization and protection of ceramic, stone or brick floors. The grooved PVC insert is in accordance with DIN 51131 regulation of non-slip stair nosing.



SP/10 aluminium + Black PVC

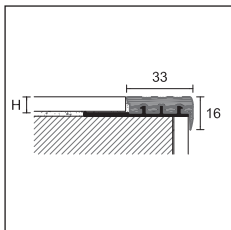

SP/



PROSTEP

| length = 270 cm - pack 10 pcs | | H | | |
|-------------------------------|-----------------------|-------|-------|-------|
| ART. | finishing | 8 | 10 | 12,5 |
| SP/ | aluminium + black PVC | 95200 | 95210 | 95220 |
| <i>euro/m</i> | | | | |

Prostep SA and SB is a line of profiles in PVC with aluminium base for realization and protection of ceramic, stone or brick floors. The grooved PVC insert is in accordance with DIN 51131 regulation of non-slip stair nosing.



SB/10 aluminium + dark grey PVC

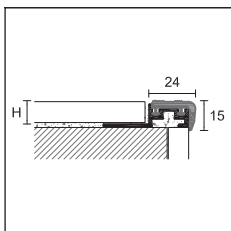

SA/



PROSTEP

| length = 270 cm - pack 10 pcs | | H | | | |
|-------------------------------|---------------------------|-------|-------|-------|----|
| ART. | finishing | 8 | 10 | 12,5 | 15 |
| SA/ | aluminium + dark grey PVC | 94041 | 94101 | 94161 | - |
| <i>euro/m</i> | | | | | - |

SPARE PVC - pack 10 pcs

| | | | | |
|---------------|---------------|-------|--|--|
| SA/G | dark grey PVC | 94913 | | |
| <i>euro/m</i> | | | | |

| length = 270 cm - pack 10 pcs | | H | | | |
|-------------------------------|-----------|---|----|------|----|
| ART. | finishing | 8 | 10 | 12,5 | 15 |

| | | | | | |
|---------------|---------------------------|-------|-------|-------|-------|
| SB/ | aluminium + dark grey PVC | 94441 | 94501 | 94561 | 94621 |
| <i>euro/m</i> | | | | | |

SPARE PVC - pack 10 pcs

| | | | | |
|---------------|---------------|-------|--|--|
| SB/G | dark grey PVC | 94963 | | |
| <i>euro/m</i> | | | | |

no partial packaging with SA/G and SB/G

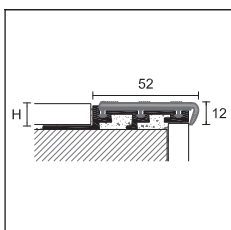

SB/

Complete the article code with H measure
(for example SWA/ for H=10 becomes SWA/10)

Prostep Flex is a line of bendable profiles for the protection of steps or platforms. These profiles can be curved through our Proflex Machine.

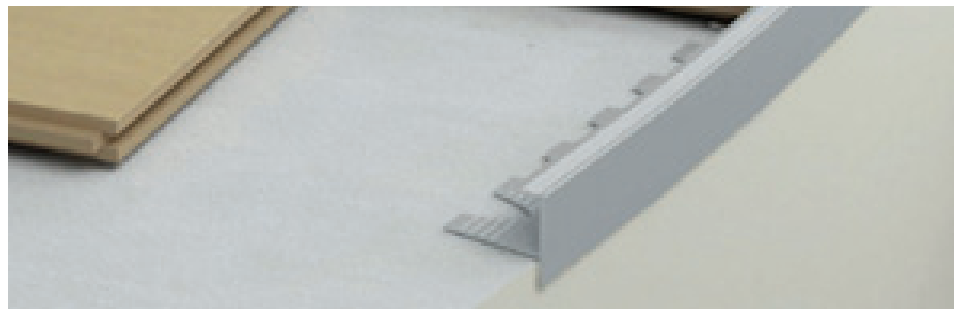

GF/710 silver anodised aluminium

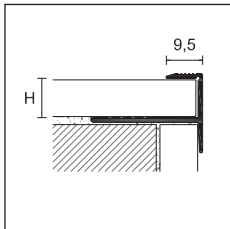

GF/

PRO FLEX LINE



PROSTEP FLEX

length = 270 cm - pack 10 pcs

| | | H | | |
|------------------|------------------|---|------------|-------|
| ART. | finishing | 10 | 15 | |
| ALUMINIUM | | 710 | 715 | |
| GF/ | silver anodised |  | 67569 | 67350 |
| euro/m | | | | |

individually packed

Prostep 111 and 75 are anodised aluminium profiles for realization and protection of stairs with low-thickness floors. They are also suitable for LVT floors, provided that they are totally glued.



111/4/F silver anodised aluminium



75/F silver anodised aluminium

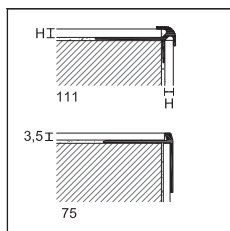

PROTECT

length = 270 cm - pack 20 pcs

| | | H | | | |
|------------------|------------------|---|------------|----------|----------|
| ART. | finishing | 2,5 | 4,5 | 5 | 6 |
| ALUMINIUM | | | | | |
| 111/ /F | silver anodised |  | 75782 | 75784 | 75785 |
| euro/m | | | | | |

PROTECT

length = 340 cm - pack 20 pcs

| | | H |
|------------------|------------------|---|
| ART. | finishing | 3,5 |
| ALUMINIUM | | |
| 75/F | silver anodised |  |
| euro/m | | 75388 |

Complete the article code with H measure (for example SA/ for H=8 becomes SA/8)

protect

Protect 73, 74 and 58 are profiles for protection of step edge in wood, ceramic or marble already laid.

Protec 87, 370 and 373 are in accordance with DIN 51131 regulation of non-slip stair nosing. They are available in version with the holes and self-adhesive.



74/SF silver anodised aluminium

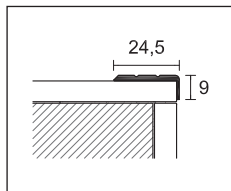

73/

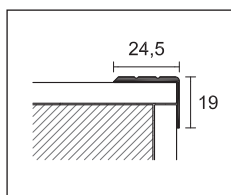

74/

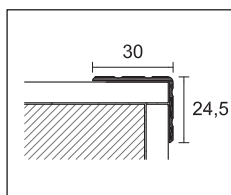

58/

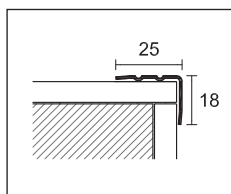

74/IF

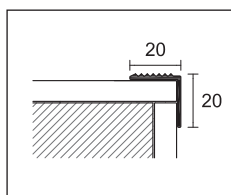

87/
370/

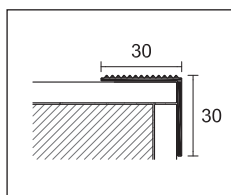

373/

PROTECT

| | | | | | | | | | | |
|---|--------|-------|--------|------------------|------------------|-------|-------|--------|-------|-------|
| pack | 30 pcs | | | 10 pcs / blister | | | | | | |
| length cm | 270 | | | 90 | 100 | | - | | | |
| ART. | 73/ | | | 473/ | | | - | | | |
| finishing | F | SF | A | CV | AD | CV | - | | | |
| ALUMINIUM | | | | | | | | | | |
| silver anodised | | 75208 | 75209 | 75238 | 21422 | 21434 | 00337 | - | | |
| euro/m | | | | | - | - | - | - | | |
| euro/pc | | - | - | - | | | | - | | |
| gold anodised | | 75218 | - | 75248 | 21423 | 21435 | 00338 | - | | |
| euro/m | | - | - | - | - | - | - | - | | |
| euro/pc | | - | - | - | | | | - | | |
| bronze anodised | | - | - | 75258 | - | - | - | - | | |
| euro/m | | - | - | - | - | - | - | - | | |
| pack | 20 pcs | | 30 pcs | | 10 pcs / blister | | | 20 pcs | | |
| ART. | 58/ | | 74/ | | 474/ | | | 74/I | | |
| finishing | A | - | F | SF | A | CV | AD | CV | | |
| ALUMINIUM | | | | | | | | | | |
| silver anodised | | 75900 | - | 75268 | 75269 | 75298 | 21512 | 21524 | 00390 | - |
| euro/m | | - | - | - | - | - | - | - | - | - |
| euro/pc | | - | - | - | - | - | | | | - |
| gold anodised | | - | - | 75278 | - | 75308 | 21513 | 21525 | 00392 | - |
| euro/m | | - | - | - | - | - | - | - | - | - |
| euro/pc | | - | - | - | - | - | | | | - |
| bronze anodised | | - | - | - | - | 75318 | - | - | - | - |
| euro/m | | - | - | - | - | - | - | - | - | - |
| titanium anodised | | - | - | - | - | 75299 | - | - | - | - |
| euro/m | | - | - | - | - | - | - | - | - | - |
| length cm | | | | | | | | | | 270 |
| STAINLESS STEEL | | | | | | | | | | |
| brushed stainless steel AISI.304 DIN 1.4301 | | - | - | - | - | - | - | - | - | 75275 |
| euro/m | | - | - | - | - | - | - | - | - | - |

art. 73/, 58/ and 74/ individually packed

PROTECT

| | | | | | | |
|------------------|--------|-------|-------|------------------|-------|-------|
| pack | 30 pcs | | | 10 pcs / blister | | |
| length cm | 340 | | | 113 | | |
| ART. | 87/ | | | 487/ | | |
| finishing | F | SF | A | CV | AD | |
| ALUMINIUM | | | | | | |
| silver anodised | | 75108 | 75109 | 75138 | 22615 | 22641 |
| euro/m | | | | | - | - |
| euro/pc | | - | - | - | | |
| pack | 10 pz | | | 5 pz | | |
| length cm | 270 | | | 270 | | |
| ART. | 370/ | | | 373/ | | |
| finishing | F | SF | A | F | A | |
| BRASS | | | | | | |
| polished | | - | 75169 | 75178 | 75188 | 75198 |
| euro/m | | - | | | | |

art. 87/ and 370/ individually packed

Complete the article code with F=drilled, A/AD=adhesive, SF=undrilled, CV=screws (eg. 73/ drilled becomes 73/F)

packaging in blister no partial packaging

Protect 70, 71 and 130 are profiles for protection of step edge in wood, ceramic or marble already laid. They are in accordance with DIN51131 regulation concerning non-slip stair nosing. They are available in the version with holes and self-adhesive and they are particularly suitable for public environments in adaptation to standards.

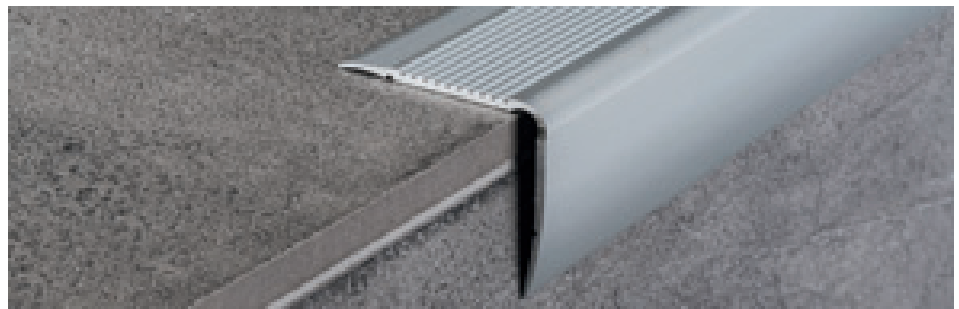

71/SF silver anodised aluminium

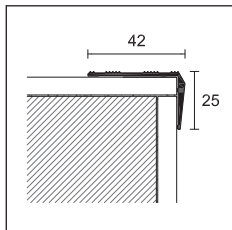

70/

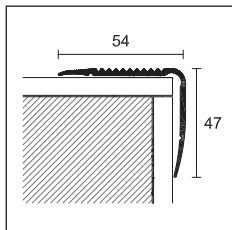

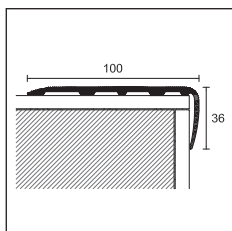

71/



130/

PROTECT

| | | | |
|------------------|---|--|----------|
| pack | 20 | 10 pcs / blister  | |
| length cm | 340 | 113 | 166 |
| ART. | 70/ | 470/ | |
| finishing | F | SF | A |
| ALUMINIUM | | | |
| silver anodised |  75328 | 75329 | 75358 |
| <i>euro/m</i> | | | |
| <i>euro/pc</i> | - | - | - |
| gold anodised |  75338 | - | 75368 |
| <i>euro/m</i> | | | |
| <i>euro/pc</i> | | | |

art. 70/ individually packed

PROTECT

| | | | |
|------------------|---|-------------|----------|
| pack | 10 pcs | 8 pcs | |
| length cm | 340 | 270 | |
| ART. | 71/ | 130/ | |
| finishing | F | SF | F |
| ALUMINIUM | | | |
| silver anodised |  64067 | 64066 | 75804 |
| <i>euro/m</i> | | | |
| <i>euro/pc</i> | | | |

Complete the article code with F=drilled, A/AD=adhesive, SF=undrilled, CV=with screws (eg. 87/ drilled becomes 87/F) -  packaging in blister no partial packaging

protect

Protect 76, 124, 110, 80 and 126 are anodised aluminium profiles with non-slip Safety-Step inserts or rubber for the protection of already-laid ceramic, wood or carpet steps. Compliant with DIN 51131 regulation regarding non-slip steps, they are available in drilled version and are particularly suitable for public spaces for the adaptation to standards.

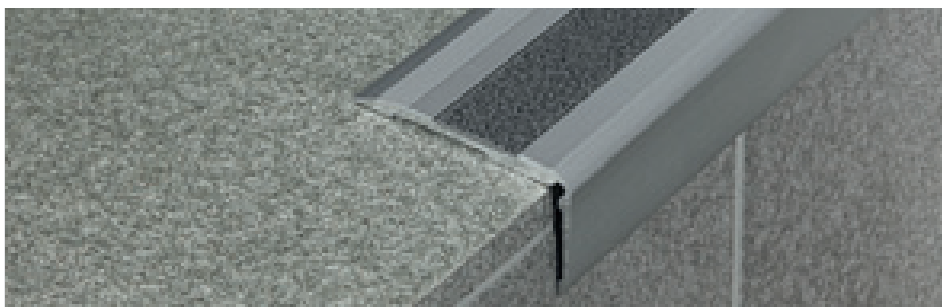

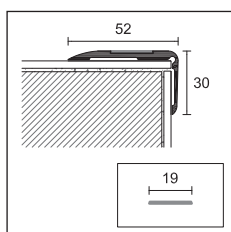

76/F silver anodised aluminium + black slip-resistant insert



76/



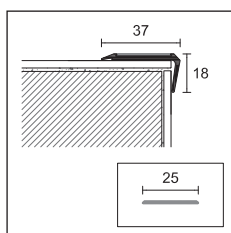

PROTECT

| | | | |
|-----------------------------|---|---|-------|
| pack | 10 pcs | 5 pcs / blister  | |
| length cm | 340 | 113 | |
| ART. | 76/ | 476/ | |
| finishing | F | CV | AD |
| ALUMINIUM | | | |
| silver anodised |  75448 | 21680 | 21696 |
| euro/m | | - | - |
| euro/pc | - | | |
| SLIP-RESISTANT ROLL | | | |
| length = 1820 cm - width mm | | 19 | |
| 4 rolls pack - | | | |
| black |  | 23002 | |
| euro/m | | | |



124/

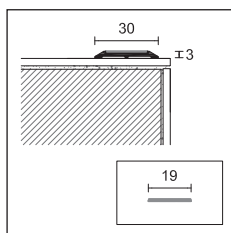

PROTECT

| | | | |
|-------------------------------|---|-------|--|
| length = 270 cm - pack 24 pcs | | | |
| ART. | | 124/ | |
| finishing | | F | |
| ALUMINIUM | | | |
| silver anodised |  | 75794 | |
| euro/m | | | |
| SLIP-RESISTANT ROLL | | | |
| length = 1820 cm - width mm | | 25 | |
| 4 rolls pack - | | | |
| black |  | 23004 | |
| euro/m | | | |



110/

PROTECT

| | | | |
|-------------------------------|---|-------|--|
| length = 270 cm - pack 24 pcs | | | |
| ART. | | 110/ | |
| finishing | | F | |
| ALUMINIUM | | | |
| silver anodised |  | 75780 | |
| euro/m | | | |
| SLIP-RESISTANT ROLL | | | |
| length = 1820 cm - width mm | | 19 | |
| 4 rolls pack - | | | |
| black |  | 23002 | |
| euro/m | | | |

The price per meter of 76/, 124/ and 110/ does not include the non-slip insert that must be ordered separately.

Complete the article code with F=drilled, AD=adhesive, CV=screws (eg. 110/ drilled becomes 110/F)

 packaging in blister no partial packaging



124/F silver anodised aluminium + black slip-resistant insert

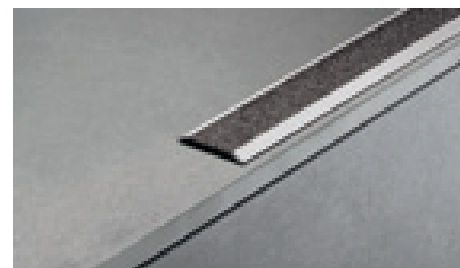

110/F silver anodised aluminium + black slip-resistant insert

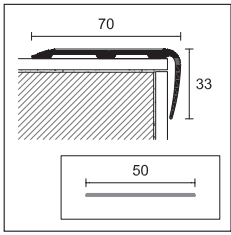

80/



PROTECT

length = 340 cm - pack 10 pcs

| | |
|------------------|------------|
| ART. | 80/ |
| finishing | F |

ALUMINIUM

| | | |
|-----------------|---|-------|
| silver anodised |  | 64077 |
| euro/m | | |

SLIP-RESISTANT ROLL

| | | |
|-----------------------------|---|-------|
| length = 1820 cm - width mm | 50 | |
| 2 rolls pack - | | |
| black |  | 23006 |
| euro/m | | |

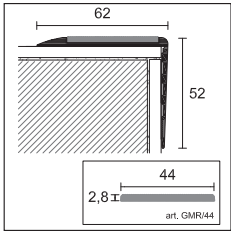

126/

PROTECT

length = 270 cm - pack 6 pcs

| | |
|------------------|-------------|
| ART. | 126/ |
| finishing | F |

ALUMINIUM

| | | |
|-----------------|---|-------|
| silver anodised |  | 75798 |
| euro/m | | |

GROOVED RUBBER

length = 1700 cm - 1 rolls pack

| | | |
|---------------|---|-------|
| ART. | GMR/44 | |
| black |  | 75706 |
| euro/m | | |



80/F silver anodised aluminium

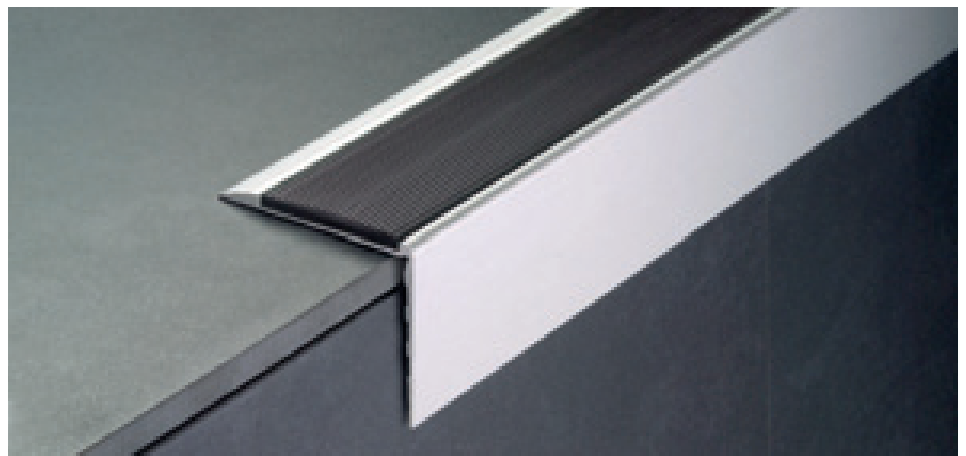

126/F silver anodised aluminium

The price per meter of 80/ does not include the non-slip insert that must be ordered separately.

The price per meter of 126/ does not include the grooved rubber that must be ordered separately.

Complete the article code with F=drilled (for example 80/ drilled becomes 80/F)

stair nosing profiles

protect

Protect 72, 79, 125 and 78 are anodised aluminium profiles with rubber insert replaceable for the protection fo step edge in ceramic, wood, marble and carpet already laid. They are in accordance with DIN 51131 regulation of non-slip stair nosing. They are available in the version with holes and they are particularly suitable for public environments in adaptation to standards.

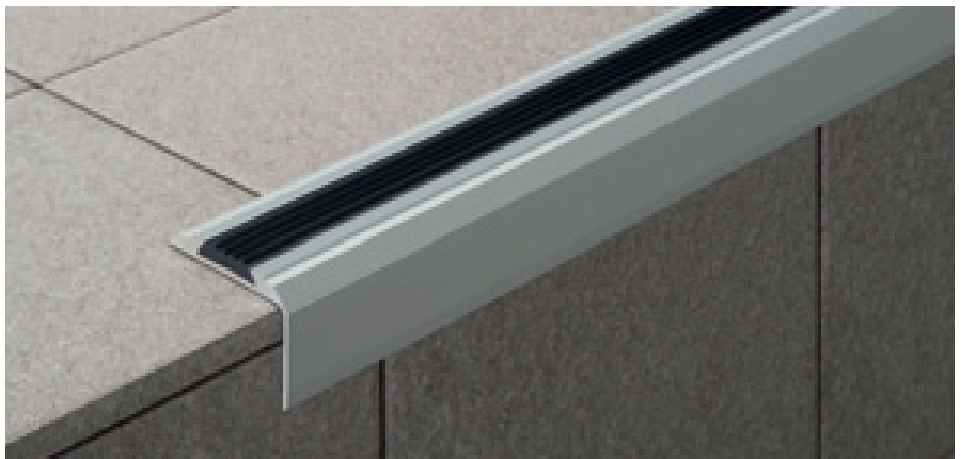

72/F silver anodised aluminium + GM/72 black

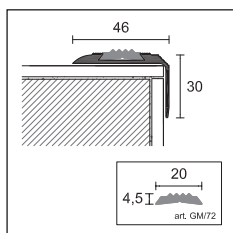

72/



PROTECT

length = 340 cm - pack 10 pcs

| | |
|-------------|------------|
| ART. | 72/ |
|-------------|------------|

| | |
|------------------|----------|
| finishing | F |
|------------------|----------|

ALUMINIUM

| | | |
|-----------------|---|-------|
| silver anodised |  | 75508 |
| euro/m | | |

| | | |
|---------------|---|-------|
| gold anodised |  | 75518 |
| euro/m | | |

GROOVED RUBBER

length = 3400 cm - 2 rolls pack

| | |
|-------------|--------------|
| ART. | GM/72 |
|-------------|--------------|

| | | |
|---------------|---|-------|
| black |  | 75565 |
| euro/m | | |

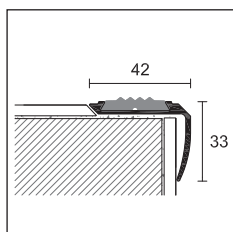

79/F + GM/R

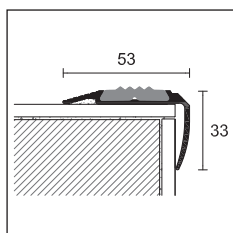

125/F + GM/R

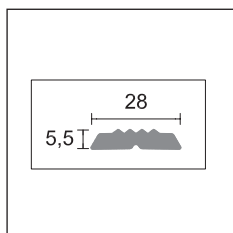

GM/R

PROTECT

| | | |
|------|----|----|
| pack | 10 | 10 |
|------|----|----|

| | | |
|-----------|-----|-----|
| length cm | 340 | 270 |
|-----------|-----|-----|

| | | |
|-------------|------------|-------------|
| ART. | 79/ | 125/ |
|-------------|------------|-------------|

| | | |
|------------------|----------|----------|
| finishing | F | F |
|------------------|----------|----------|

ALUMINIUM

| | | | |
|-----------------|---|-------|-------|
| silver anodised |  | 75728 | 75796 |
| euro/m | | | |

GROOVED RUBBER

length = 3400 cm - 2 rolls pack

| | |
|-------------|-------------|
| ART. | GM/R |
|-------------|-------------|

| | | |
|---------------|---|-------|
| black |  | 75705 |
| euro/m | | |

The price per meter of 72/, 79/ and 125/ does not include the grooved rubber that must be ordered separately.

Complete the article code with F=drilled (for example 72/ drilled becomes 72/F)

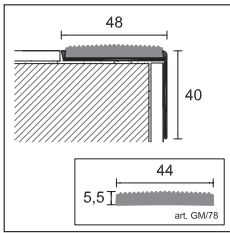

78/



PROTECT

length = 340 cm - pack 20 pcs

ART. **78/**

finishing **F**

ALUMINIUM

silver anodised  75578

euro/m

GROOVED RUBBER

length = 1700 cm - 2 rolls pack

ART. **GM/78**

black  75635

euro/m



125/F silver anodised aluminium + GM/R black

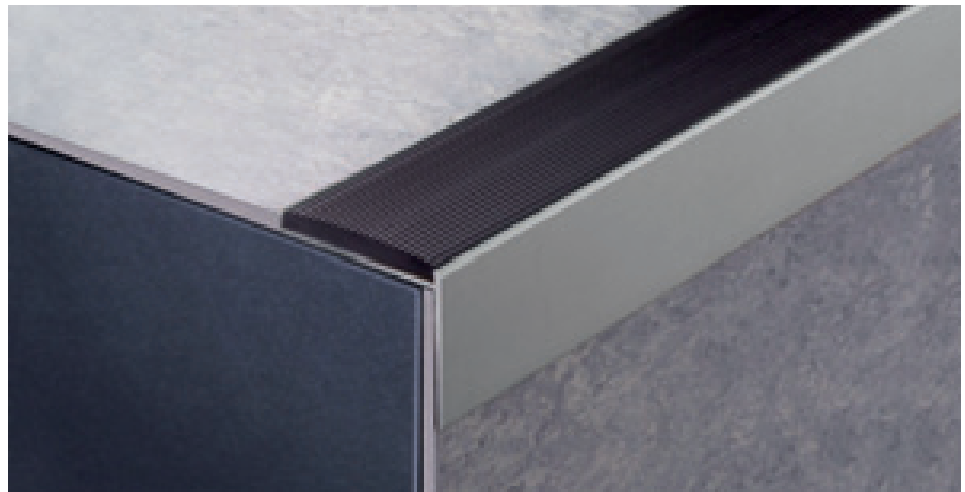

78/F silver anodised aluminium

The price per meter of 78/ does not include the grooved rubber that must be ordered separately.

Complete the article code with F=drilled (for example 78/ drilled becomes 78/F)

stair nosing profiles

protect

Protect 150, 151, 152, 154, 155 and 156 are PVC profiles for the protection of step edge in ceramic, marble, wood, PVC, linoleum, carpet or LVT floors (provided that they are totally glued).

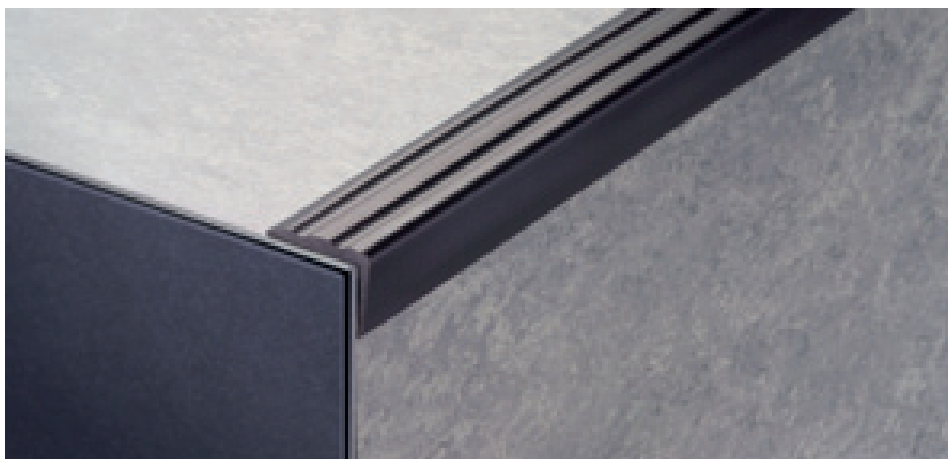

150 Black PVC

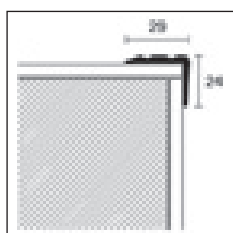

150





PROTECT

length = 300 cm - pack 15 pcs

ART. finishing

PVC

| | | | |
|-----|---------------|---|-------|
| | black |  | 19100 |
| 150 | grey |  | 19101 |
| | brown |  | 19102 |
| | euro/m | | |

no partial packaging

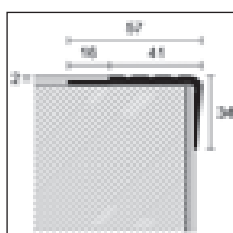

151

PROTECT

length = 300 cm - pack 15 pcs

ART. finishing

PVC

| | | | |
|-----|---------------|---|-------|
| | black |  | 19110 |
| 151 | grey |  | 19111 |
| | brown |  | 19112 |
| | euro/m | | |

no partial packaging

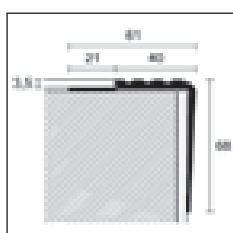

152

PROTECT

length = 300 cm - pack 15 pcs

ART. finishing

PVC

| | | | |
|-----|---------------|---|-------|
| | black |  | 19120 |
| 152 | grey |  | 19121 |
| | brown |  | - |
| | euro/m | | |

no partial packaging



151 Black PVC

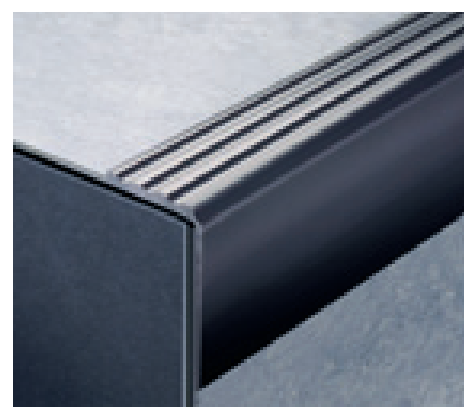

152 Grey PVC

All articles Protect in PVC should be stored horizontally

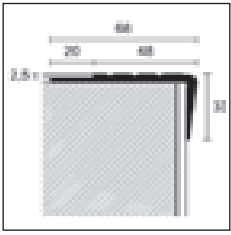

154



PROTECT

length = 300 cm - pack 15 pcs

ART. finishing

PVC

| | | | |
|------------|---------------|---|-------|
| | black |  | 19140 |
| 154 | grey |  | 19141 |
| | brown |  | - |
| | euro/m | | |

no partial packaging

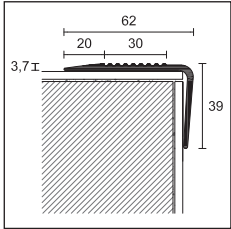

155

PROTECT

length = 300 cm - pack 15 pcs

ART. finishing

PVC

| | | | |
|------------|---------------|---|-------|
| | black |  | 19150 |
| 155 | grey |  | 19151 |
| | brown |  | 19152 |
| | euro/m | | |

no partial packaging

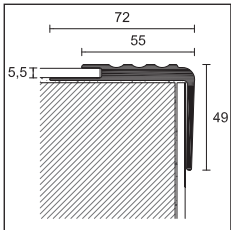

156

PROTECT

length = 300 cm - pack 10 pcs

ART. finishing

PVC

| | | | |
|------------|---------------|---|-------|
| | black |  | 19160 |
| 156 | grey |  | 19161 |
| | brown |  | 19162 |
| | euro/m | | |

no partial packaging

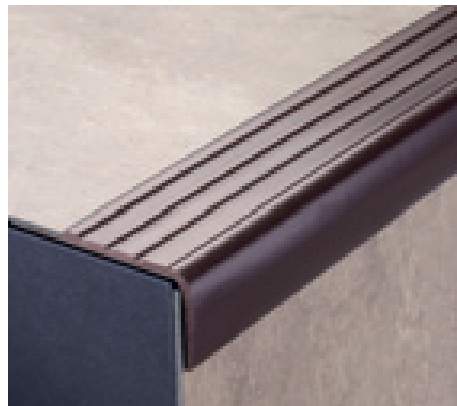

154 Brown PVC



155 Black PVC

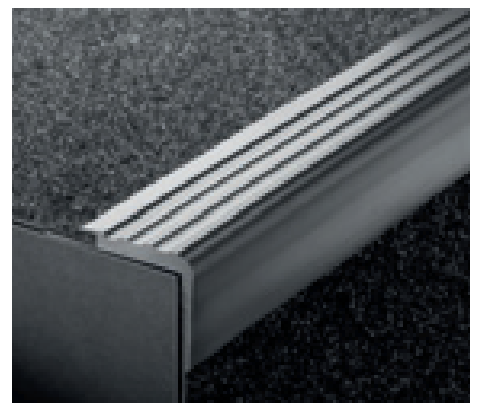

156 Grey PVC

All articles Protect in PVC should be stored horizontally

safety-step

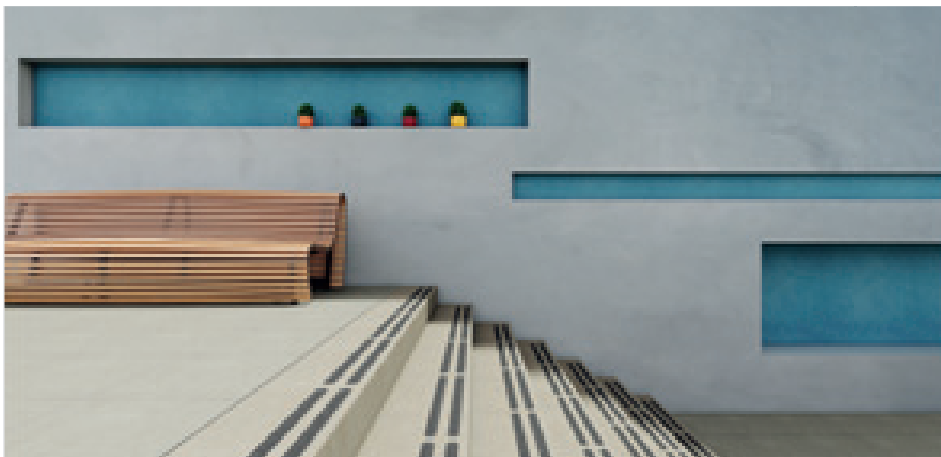

Slip -resistant strips Safety-Step: it is a line of anti-slip adhesive coverings consisting of abrasive particles aggregated by synthetic resins on dimensionally stable support. Suitable for all surfaces subjected to heavy traffic, both pedestrian and vehicular, such as stairs, hall of office and apartment buildings, ramps, walkways, elevators, platforms machinery, emergency exits etc..



Safety-Step - slip-resistant strip



SAFETY-STEP - SLIP-RESISTANT STRIP

| colour | | width (mm) | length (cm) | code | euro/pc | pack |
|-------------|---|------------|-------------|-------|---------|---|
| black | ■ | 19 | 61 | 23000 | | 50 |
| black | ■ | 25 | 61 | 23001 | | 50 |
| black | ■ | 19 | 61 | 23100 | | 10 pcs/ blister  |
| black | ■ | 25 | 61 | 23101 | | 10 pcs/ blister  |
| transparent | | 19 | 61 | 23016 | | 50 |

no partial packaging - one blister contains 4 strips



Safety-Step - slip-resistant strip



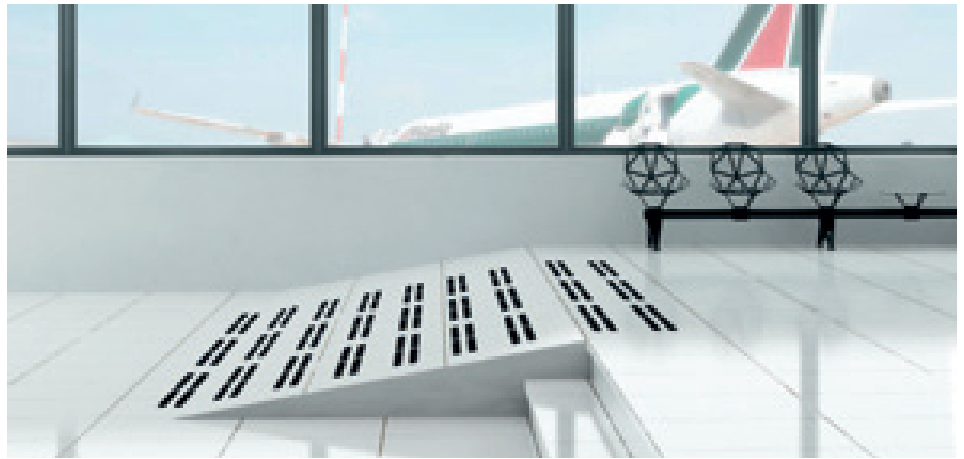





Slip-resistant rolls Safety-Step: it is a line of anti-slip adhesive coverings consisting of abrasive particles aggregated by synthetic resins on dimensionally stable support. Suitable for all surfaces subjected to heavy traffic, both pedestrian and vehicular, such as stairs, hall of office and apartment buildings, ramps, walkways, elevators, platforms machinery, emergency exits etc.. The grey versions (Resilient Medium / Fine) consist of a rubber surface, and are perfect for areas of the walkway also barefoot such as showers, locker rooms, saunas, boats, sports equipment and etc...



Safety-Step - slip-resistant strip



SAFETY-STEP - SLIP-RESISTANT ROLL

| colour | | width (mm) | length (cm) | code | euro/pc | pack |
|-------------|---|------------|-------------|-------|---------|--|
| black |  | 19 | 1820 | 23002 | | 4 |
| black |  | 25 | 1820 | 23004 | | 4 |
| black |  | 50 | 1820 | 23006 | | 2 |
| black |  | 19 | 360 | 23103 | | 10 pcs/blister  |
| black |  | 25 | 360 | 23105 | | 10 pcs/blister  |
| transparent | | 19 | 1820 | 23018 | | 4 |
| transparent | | 25 | 1820 | 23020 | | 4 |
| transparent | | 50 | 1820 | 23022 | | 2 |
| grey |  | 25 | 1820 | 23044 | | 4 |
| grey |  | 50 | 1820 | 23046 | | 2 |



Safety-Step - slip-resistant roll

prostair

Prostair is a system composed of a profile and its relative accessories for the anchorage of stair rods on steps. The fixing accessories permit a quick removal of the stair rods for cleaning or replacement.

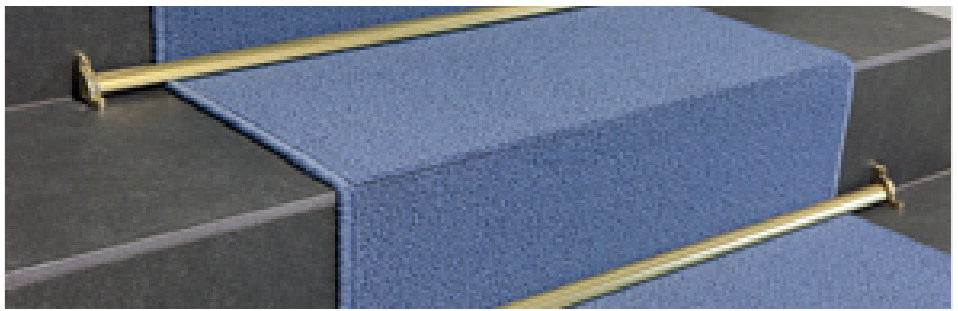

155/16 bright polished gold aluminium + 177/16

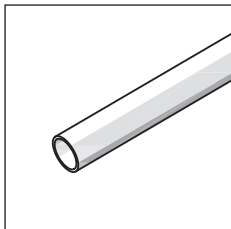

151/11



PROSTAIR

length = 380 cm - diameter 11 - pack 20 pcs

ART. finishing

ALUMINIUM

151/11 bright polished silver  78430
euro/m

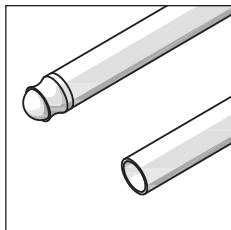

150/

PROSTAIR

pack 20 pcs

| length cm | 80 | 90 | 100 | 120 | 380 |
|-----------|----|----|-----|-----|-----|
|-----------|----|----|-----|-----|-----|

ART. finishing

ALUMINIUM

| | | diameter | | | | |
|------|---------|----------|-------|-------|-------|-------|
| | 11 | 78311 | 78312 | 78313 | 78314 | 78319 |
| | euro/pc | | | | | - |
| | euro/m | - | - | - | - | - |
| 150/ | 13 | 78321 | - | 78323 | - | 78329 |
| | euro/pc | | | | | - |
| | euro/m | - | - | - | - | - |
| | 16 | - | - | - | - | 78339 |
| | euro/m | - | - | - | - | - |

pack 10 pcs / blister 

| | | | | | | | | |
|-----------|----------------------|---|----|-------|-------|-------|---|---|
| 4150/11/S | bright polished gold |  | 11 | 21810 | 21811 | 21812 | - | - |
| | euro/blister | | | | | | - | - |

articles 150/11, 150/13 and 150/16 of 380 cm partial packaging available and without knobs, for other articles no partial packaging - article 150/13 of 380 cm pack 40 pcs - article 150/16 of 380 cm pack 25 pcs

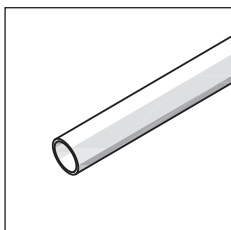

163/

PROSTAIR

| pack | 10 pcs | 10 pcs | 10 pcs | | |
|-----------------|----------|---|--------|-------|-------|
| length = 380 cm | | | | | |
| finishing | | | | | |
| BRASS | diameter | | | | |
| | 11 | 13 | 16 | | |
| 163/ | polished |  | 78801 | 78802 | 78803 |
| | euro/m | | | | |

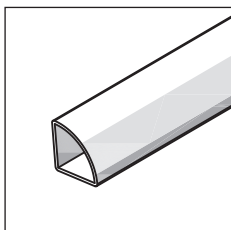

155/16

OTHER PROFILES

length = 300 cm - pack 20 pcs

ART. finishing 16x16

ALUMINIUM

155/16 bright polished gold  78379
euro/m

art. 163/ available in different lengths on request, extra €/pc

Complete the article code with the diameter measure (for example 150/ for diameter=11 becomes 150/11)

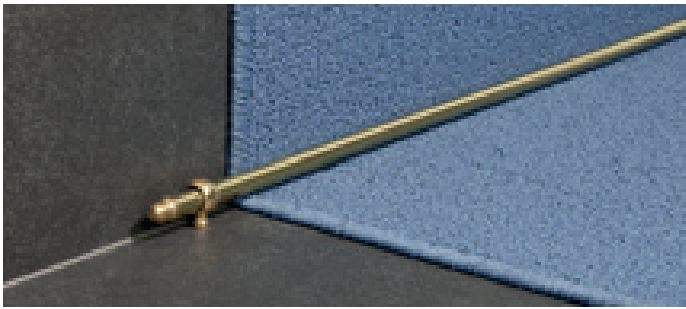

163/13 polished brass + 170/13



155/16 bright polished gold aluminium + 168/16 + 178/16

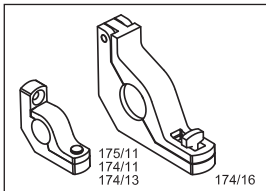

175/11 + 174/

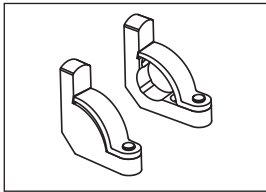

177/16

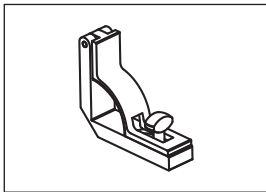

178/16

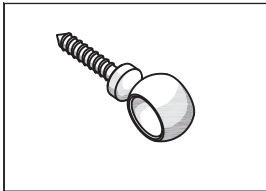

171/ + 170/

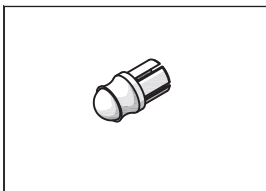

161/11 + 169/

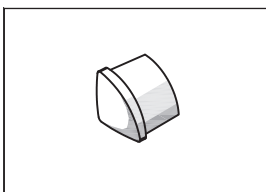

168/16

ACCESSORIES - BRACKETS

| pack 20 pcs | | diameter | | |
|-----------------------------|--------------------|----------|----|-------|
| ART. | finishing | 11 | 13 | 16 |
| BRASS | | | | |
| 175/11 | chromium plated | 78445 | - | - |
| | <i>euro/pc</i> | | - | - |
| pack 20 pcs | | | | |
| 174/ | polished | 78410 | - | 78412 |
| | <i>euro/pc</i> | | - | - |
| pack 10 couples 2 pcs dx/sx | | | | |
| 177/16 | polished | - | - | 78415 |
| | <i>euro/couple</i> | - | - | - |
| pack 20 pcs | | measures | | |
| | | 16x16 | | |
| 178/16 | polished | 78420 | | |
| | <i>euro/pc</i> | | | |

ACCESSORIES - RINGS

| pack 20 pcs | | diameter | | |
|---------------------------------|---------------------|----------|-------|-------|
| ART. | finishing | 11 | 13 | 16 |
| BRASS | | | | |
| 171/11 | chromium plated | 78440 | - | - |
| | <i>euro/pc</i> | | - | - |
| pack 20 pcs | | | | |
| 170/ | polished | 78400 | 78401 | 78402 |
| | <i>euro/pc</i> | | | |
| 10 blister packs/ 4 pcs/blister | | | | |
| 4170/ /S | polished | 21852 | - | - |
| | <i>euro/blister</i> | | - | - |
| no partial packaging | | | | |

ACCESSORIES - KNOBS

| pack 20 pcs | | diameter | | |
|----------------------|--|----------|-------|-------|
| ART. | finishing | 11 | 13 | 16 |
| BRASS | | | | |
| 161/11 | chromium plated | 78435 | - | - |
| | <i>euro/pc</i> | | - | - |
| pack 20 pcs | | | | |
| 169/ | brass (for aluminium and brass profiles) | 78395 | 78396 | 78397 |
| | <i>euro/pc</i> | | | |
| pack 20 pcs | | 16x16 | | |
| 168/16 | polished | 78418 | | |
| | <i>euro/pc</i> | | | |
| no partial packaging | | | | |

Complete the article code with diameter measure (eg. 174/ for diameter=11 becomes 174/11)





profiles for wooden, laminare and LVT floors

A full range of profiles for wooden, laminate and LVT floors (glue-down, loose-lay and click). A series of systems and professional solutions proposed in different colours of anodised aluminium and in the exclusive finishes Alcrom® Plus, with the possibility of further customization thanks to PDS technology.

profiles for wooden and laminate floors

unisystem plus



Unisystem Plus is a system for the floating installation of wooden and laminate floors from 6,5 to 22,6 mm thickness. Composed of connection profiles for same and different level floors, perimetral profiles and stair nosing profiles, Unisystem Plus is easy to lay and simple to remove. The system is composed of a top profile, an aluminium base and a fixing clip: after inserting the fixing clip in the top profile, just push the top profile to fix it to the aluminium base.

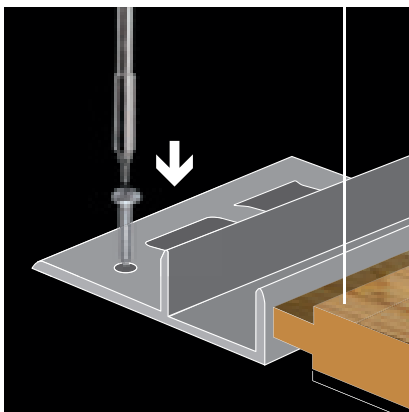

fix the aluminium base to the subfloor with screws or glue

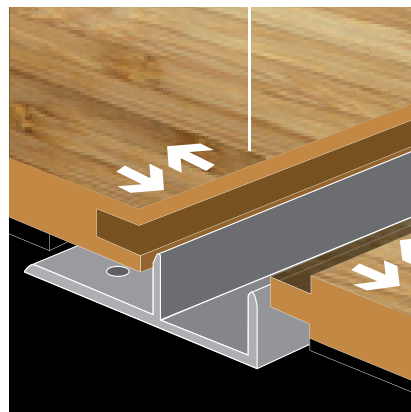

bring the floor planks closer

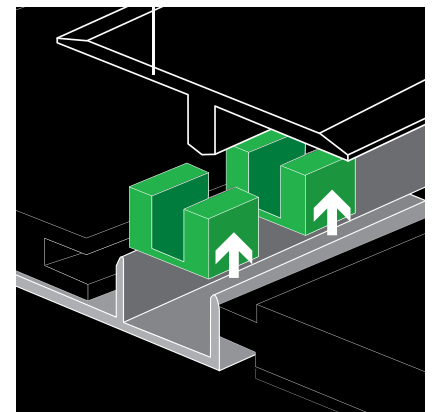

insert the clips in the top profile

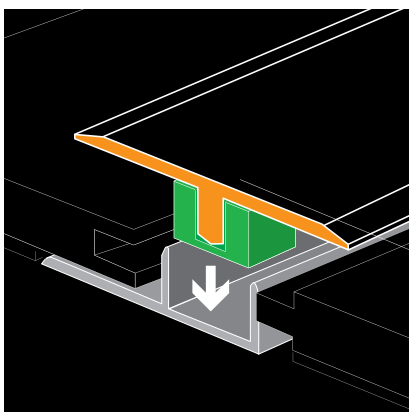

put the top profile in the base

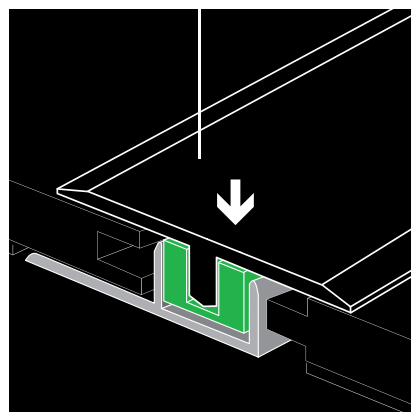

push the top profile in the base

Unisystem Plus line

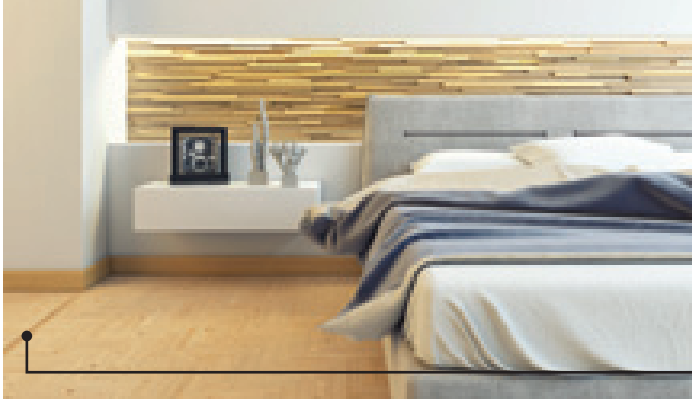

Connection profiles for floors of same level

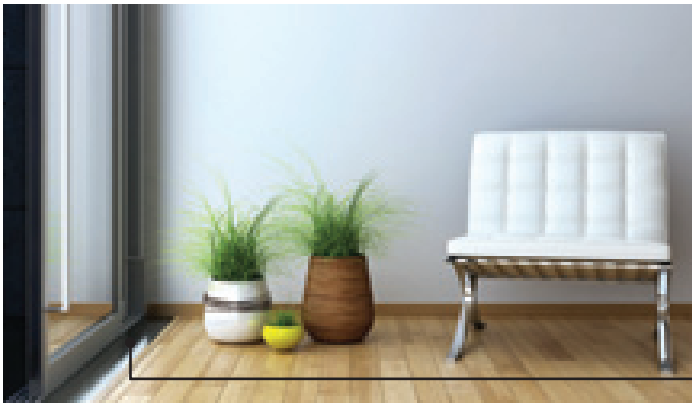

Connection profiles for floors of different level



Perimetral profiles

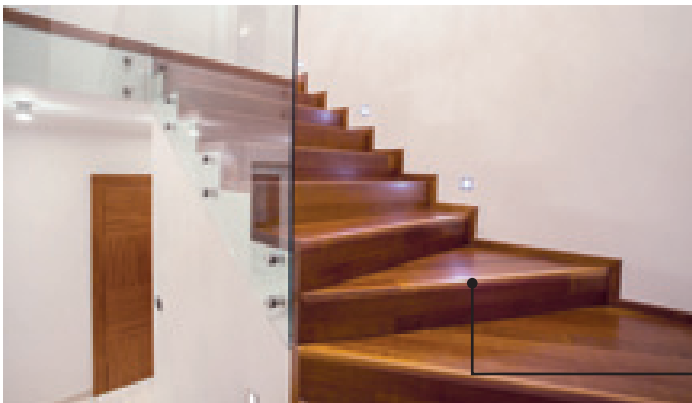

Stair nosing profiles



unisystem - unisystem plus

Unisystem Plus is a system for the floating installation of wooden and laminate floors from 6,5 to 22,6 mm thickness, composed of junction profiles for same level floors (Z/ series), connection profiles for different level floors (C/ series) and perimetral profiles (S/ series). The system is composed of a natural aluminium base and a top profile to be fixed on the base through a specific clip. The top profile is available in different finishes of anodised aluminium or covered with wood-effect Alcrom® Plus film for matching the floor perfectly.



Unisystem Plus S/9/SF, Z/1/SF and C/7/SF

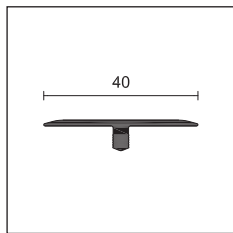

Z/1/SF

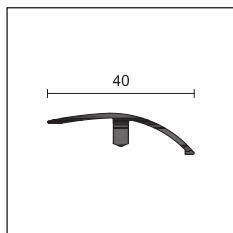

C/7/SF

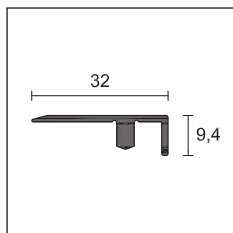

S/9/SF



UNISYSTEM PLUS

length = 270 cm - pack 10 pcs

| ART. | finishing | Z/1/SF | C/7/SF | S/9/SF |
|------------------------------|-----------|----------|--------|----------|
| floor thickness from / to mm | | 6,5/22,6 | 6,5/10 | 6,5/22,6 |

ALUMINIUM covered with ALCROM® PLUS film

| | | | |
|----|-------|-------|-------|
| 02 | 66301 | 66001 | 65701 |
| 05 | 66306 | 66006 | 65706 |
| 08 | 66304 | 66004 | 65704 |
| 10 | 66307 | 66007 | 65707 |
| 11 | 66308 | 66008 | 65708 |
| 12 | 66309 | 66009 | 65709 |
| 13 | 66310 | 66010 | 65710 |
| 14 | 66311 | 66011 | 65711 |
| 18 | 66316 | 66016 | 65716 |
| 19 | 66318 | 66018 | 65718 |
| 20 | 66317 | 66017 | 65717 |
| 26 | 66321 | 66021 | 65721 |
| 31 | 66328 | 66028 | 65728 |
| 32 | 66329 | 66029 | 65729 |
| 34 | 66331 | 66031 | 65731 |
| 35 | 66332 | 66032 | 65732 |
| 36 | 66333 | 66033 | 65733 |
| 37 | 66334 | 66034 | 65734 |
| 38 | 66335 | 66035 | 65735 |
| 39 | 66336 | 66036 | 65736 |
| 40 | 66337 | 66037 | 65737 |
| 41 | 66338 | 66038 | 65738 |
| 42 | 66339 | 66039 | 65739 |
| 43 | 66340 | 66040 | 65740 |
| 44 | 66341 | 66041 | 65741 |
| 47 | 66344 | 66044 | 65744 |
| 65 | 66365 | 66065 | 65765 |
| 71 | 66368 | 66068 | 65768 |
| 72 | 66369 | 66069 | 65769 |
| 73 | 66370 | 66070 | 65770 |
| 74 | 66371 | 66071 | 65771 |
| 76 | 66374 | 66074 | 65774 |
| 77 | 66372 | 66072 | 65772 |
| 78 | 66376 | 66076 | 65776 |
| 79 | 66373 | 66073 | 65773 |
| 80 | 66377 | 66077 | 65777 |
| 81 | 66378 | 66078 | 65778 |
| 89 | 66386 | 66086 | 65784 |

euro/m

individually packed

UNISYSTEM PLUS

length = 270 cm - pack 10 pcs

| ART. | finishing | Z/1/SF | C/7/SF | S/9/SF |
|------------------------------|-----------|----------|--------|----------|
| floor thickness from / to mm | | 6,5/22,6 | 6,5/10 | 6,5/22,6 |

ALUMINIUM covered with ALCROM® PLUS film

| | | | |
|----------|-------|-------|-------|
| 91 | 66388 | 66088 | 65786 |
| 92 | 66389 | 66089 | 65789 |
| 93 | 66390 | 66090 | 65790 |
| 94 | 66391 | 66091 | 65791 |
| 95 | 66392 | 66092 | 65792 |
| 351 | 66393 | 66093 | - |
| 363 | 66394 | 66094 | - |
| 372 | 66395 | 66095 | - |
| 490 | 66397 | 66097 | - |
| 560 | 66398 | 66098 | - |
| 580 | 66399 | 66099 | 65793 |
| 590 | 66400 | 66100 | - |
| 665 | 66401 | 66101 | 65794 |
| 670 | 66402 | 66102 | 65795 |
| 951 | 66408 | 66108 | 65797 |
| 975 | 66409 | 66109 | 65798 |
| 1024 | 66410 | 66110 | 65799 |
| 1033 | 66411 | 66111 | 65800 |
| 1042 | 66412 | 66112 | 65801 |
| 1090 | 66414 | 66114 | 65803 |
| 1202 | 66416 | 66116 | 65805 |
| 1203 | 66417 | 66117 | 65806 |
| 1204 | 66418 | 66118 | 65807 |
| 1205 | 66419 | 66119 | 65808 |
| 1206 | 66420 | 66120 | 65809 |
| 1207 | 66421 | 66121 | 65810 |
| 1208 | 66422 | 66122 | 65811 |
| 1209 | 66423 | 66123 | 65812 |
| 1210 | 66424 | 66124 | 65813 |
| 1211 | 66425 | 66125 | 65814 |
| 1212 | 66426 | 66126 | 65815 |
| 1213 | 66427 | 66127 | 65816 |
| 1214 | 66428 | 66128 | 65817 |
| 1215 | 66429 | 66129 | 65818 |
| 1216 | 66430 | 66130 | 65819 |
| 1217 | 66431 | 66131 | 65820 |
| 100 | 66432 | 66132 | - |
| black 97 | 66433 | 66133 | 65821 |

euro/m

individually packed

Profiles of 270 cm length: please order the base separately.

Customized PDS decors on request, see page 191



UNISYSTEM PLUS

length = 270 cm - pack 20 pcs

| ART. | finishing | Z/1/SF | C/7/SF | S/9/SF |
|------|-----------|----------|--------|----------|
| | | 6,5/22,6 | 6,5/10 | 6,5/22,6 |

ANODISED ALUMINIUM

| | | | | |
|--------|--|-------|-------|-------|
| silver | | 67217 | 67007 | 65680 |
|--------|--|-------|-------|-------|

euro/m

| | | | | |
|----------|--|-------|-------|-------|
| titanium | | 67238 | 67000 | 65691 |
|----------|--|-------|-------|-------|

| | | | | |
|------|--|-------|-------|-------|
| gold | | 67227 | 67017 | 65685 |
|------|--|-------|-------|-------|

| | | | | |
|-----------|--|-------|-------|-------|
| gold sand | | 67234 | 67024 | 65688 |
|-----------|--|-------|-------|-------|

| | | | | |
|--------|--|-------|-------|-------|
| bronze | | 67237 | 67027 | 65690 |
|--------|--|-------|-------|-------|

euro/m

Other models for thicker floors available on page 172 individually packed

UNISYSTEM PLUS - BASES

| | | | | | |
|------------------------------|--------|----------|-----------|-------|-----------|
| floor thickness from / to mm | 6,5/10 | 9,6/12,5 | 12,6/15,5 | 15/19 | 19,6/22,6 |
|------------------------------|--------|----------|-----------|-------|-----------|

length = 270 cm
pack 20 pcs (15 clips TU/6 included)

| ART. | finishing | 6 | 10 | 13 | 15 | 22 |
|------|-----------|---|----|----|----|----|
| | | | | | | |

ALUMINIUM

| | | | | | | | |
|------|-------------------|--|-------|-------|-------|-------|-------|
| TPU/ | natural aluminium | | 67437 | 67447 | 67457 | 67460 | 67467 |
|------|-------------------|--|-------|-------|-------|-------|-------|

euro/m

individually packed (art. TPU/22 pack 10 pcs)

SPARE CLIPS

pack of 150 pcs

| | |
|--|---|
| | H |
|--|---|

| | |
|--|---|
| | 6 |
|--|---|

| | |
|------|-----------|
| TU/6 | 68812/150 |
|------|-----------|

euro/pack

no partial packaging

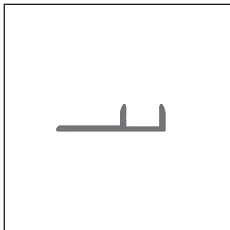

TPU/

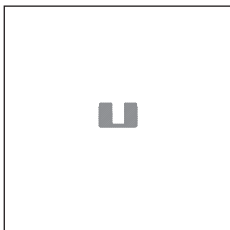

TU/6



Z/1/SF aluminium covered with Alchrom® Plus film



C/7/SF aluminium covered with Alchrom® Plus film



S/9/SF aluminium covered with Alchrom® Plus film

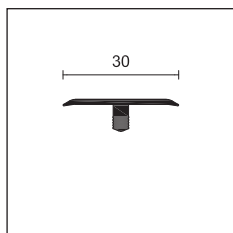

Z3/30/SF

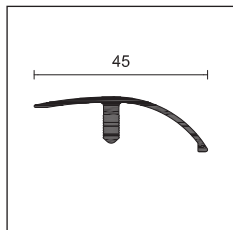

C/10/SF

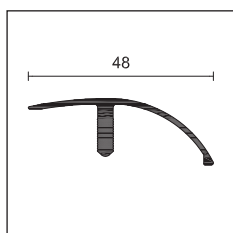

C/13/SF

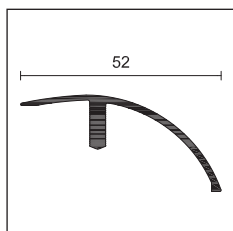

C/22/SF

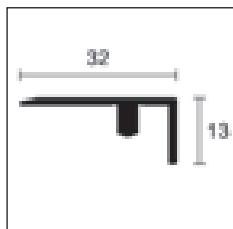

S/15/SF

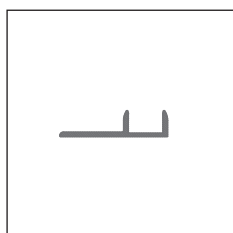

TPU/

UNISYSTEM PLUS

| | | | | | | |
|------------------------------|------------------|-----------------|----------------|----------------|----------------|----------------|
| length = 270 cm | pack 20 pcs | pack 20 pcs | pack 10 pcs | pack 10 pcs | pack 10 pcs | |
| ART. | finishing | Z3/30/SF | C/10/SF | C/13/SF | C/22/SF | S/15/SF |
| floor thickness from / to mm | | 6,5/22,6 | 9,6/12,5 | 12,6/15,5 | 15/22,6 | 9,6/22,6 |

ANODISED ALUMINIUM

| | | | | | | |
|---------------------|--|-------|-------|-------|-------|-------|
| silver | | 63700 | 67077 | 67147 | 66907 | 65480 |
| euro/m | | | | | | |
| gold | | 63702 | 67087 | 67157 | - | - |
| gold sand | | 63704 | - | - | - | 65488 |
| euro/m | | | | | | |
| individually packed | | | | | | |

UNISYSTEM PLUS - BASES

| | | | | | |
|--------------------------------------|----------|----------|-----------|-------|-----------|
| floor thickness from / to mm | 6,5/10 | 9,6/12,5 | 12,6/15,5 | 15/19 | 19,6/22,6 |
| length = 270 cm | | | | | |
| pack 20 pcs (15 clips TU/6 included) | H | | | | |

| | | | | | | |
|-------------|------------------|----------|-----------|-----------|-----------|-----------|
| ART. | finishing | 6 | 10 | 13 | 15 | 22 |
|-------------|------------------|----------|-----------|-----------|-----------|-----------|

ALUMINIUM

| | | | | | | | |
|---------------|-------------------|--|-------|-------|-------|-------|-------|
| TPU/ | natural aluminium | | 67437 | 67447 | 67457 | 67460 | 67467 |
| euro/m | | | | | | | |

individually packed (art. TPU/22 pack 10 pcs)

SPARE CLIPS

| | |
|-----------------|----------|
| pack da 150 pcs | H |
| | 6 |

| | |
|-------------|-----------|
| TU/6 | 68812/150 |
|-------------|-----------|

euro/pack

no partial packaging



unisystem - unisystem plus

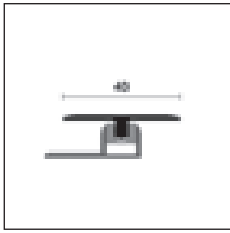

TPZ/

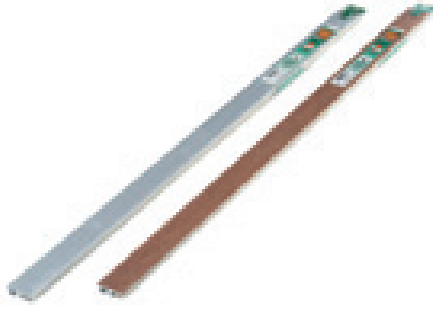

TPZ/47/CV silver anodised aluminium and aluminium covered with Alcrom® Plus film

UNISYSTEM PLUS

length = 90 cm - pack 10 pcs / blister - for floor thicknesses from 6,5 to 10 mm

ART. finishing

ALUMINIUM covered with ALCROM® PLUS film

| | | | | | | | | |
|-----------|----|-------|--|------|-------|--|------|-------|
| | 05 | 43005 | | 77 | 43011 | | 1208 | 43027 |
| | 10 | 43020 | | 78 | 43066 | | 1209 | 43029 |
| | 14 | 43006 | | 80 | 43068 | | 1210 | 43030 |
| | 19 | 43007 | | 89 | 43012 | | 1211 | 43031 |
| | 20 | 43028 | | 91 | 43013 | | 1212 | 43033 |
| TPZ/47/CV | 26 | 43008 | | 580 | 43014 | | 1213 | 43035 |
| | 31 | 43009 | | 1202 | 43016 | | 1214 | 43037 |
| | 38 | 43034 | | 1203 | 43017 | | 1215 | 43039 |
| | 39 | 43010 | | 1204 | 43018 | | 1216 | 43041 |
| | 40 | 43036 | | 1205 | 43019 | | 1217 | 43043 |
| | 42 | 43038 | | 1206 | 43025 | | | |
| | 65 | 43056 | | 1207 | 43026 | | | |

euro/pc

individually packed

UNISYSTEM PLUS

length = 90 cm - pack 10 pcs / blister

ART. finishing TPZ/47/CV TPZ/410/CV TPZ/413/CV

floor thickness from / to mm 6,5 / 10 9,6 / 12,5 12,6 / 15,5

ANODISED ALUMINIUM

| | | | | |
|--------|--|-------|-------|-------|
| silver | | 43000 | 43072 | 43144 |
| gold | | 43004 | 43076 | 43148 |

euro/pc

individually packed - gold anodised extra euro/pc + 0,57

UNISYSTEM PLUS

length = 90 cm - pack 10 pcs / blister - for floor thicknesses from 6,5 to 10 mm

ART. finishing

ALUMINIUM covered with ALCROM® PLUS film

| | | | | | | | | |
|-----------|----|-------|--|------|-------|--|------|-------|
| | 05 | 43219 | | 77 | 43225 | | 1208 | 43239 |
| | 10 | 43234 | | 78 | 43280 | | 1209 | 43240 |
| | 14 | 43220 | | 80 | 43282 | | 1210 | 43241 |
| | 19 | 43221 | | 89 | 43226 | | 1211 | 43243 |
| | 20 | 43242 | | 91 | 43227 | | 1212 | 43244 |
| TPC/47/CV | 26 | 43222 | | 580 | 43228 | | 1213 | 43245 |
| | 31 | 43223 | | 1202 | 43231 | | 1214 | 43247 |
| | 38 | 43248 | | 1203 | 43232 | | 1215 | 43249 |
| | 39 | 43224 | | 1204 | 43233 | | 1216 | 43251 |
| | 40 | 43250 | | 1205 | 43235 | | 1217 | 43253 |
| | 42 | 43252 | | 1206 | 43236 | | | |
| | 65 | 43270 | | 1207 | 43237 | | | |

euro/pc

individually packed

UNISYSTEM PLUS

length = 90 cm - pack 10 pcs / blister

ART. finishing TPC/47/CV TPC/410/CV TPC/413/CV

floor thickness from / to mm 6,5 / 10 9,6 / 12,5 12,6 / 15,5

ANODISED ALUMINIUM

| | | | | |
|--------|--|-------|-------|-------|
| silver | | 43214 | 43286 | 43358 |
| gold | | 43218 | 43290 | 43362 |

euro/pc

individually packed - gold anodised extra euro/pc + 0,57

UNISYSTEM PLUS

length = 90 cm - pack 10 pcs / blister

ART. finishing TPS/47/CV TPS/410/CV TPS/413/CV

floor thickness from / to mm 6,5 / 10 9,6 / 12,5 12,6 / 15,5

ANODISED ALUMINIUM

| | | | | |
|--------|--|-------|-------|-------|
| silver | | 43430 | 43502 | 43574 |
|--------|--|-------|-------|-------|

euro/pc

individually packed

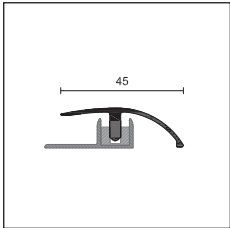

TPC/

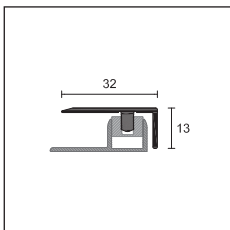

TPS/

The blister pack contains base, clips and profile.

unisystem plus

G/2/SF is a stair nosing profile of Unisystem Plus line. Composed of a base and a top profile, it is suitable for the installation of floating wooden and laminate with thicknesses from 6,5 to 12,5 mm.

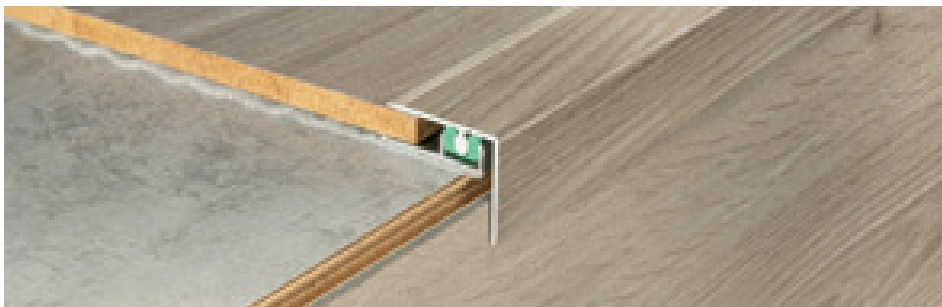

G/2/SF aluminium covered with Alcrom® Plus film

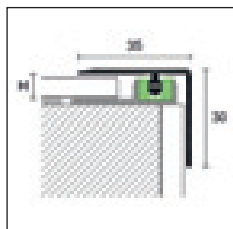

G/2/SF + TPU/



UNISYSTEM PLUS

length = 270 cm - pack 10 pcs - for floor thicknesses from 6,5 to 12,5 mm

ART. finishing

ALUMINIUM covered with ALCROM® PLUS film

| | | | | | | | | |
|---------------|----|-------|--|------|-------|--|------|-------|
| | 05 | 43645 | | 41 | 43656 | | 1207 | 43668 |
| | 08 | 43646 | | 77 | 43657 | | 1208 | 43669 |
| | 12 | 43647 | | 89 | 43658 | | 1209 | 43670 |
| | 13 | 43648 | | 91 | 43659 | | 1210 | 43671 |
| | 14 | 43649 | | 93 | 43660 | | 1211 | 43672 |
| G/2/SF | 19 | 43650 | | 580 | 43661 | | 1212 | 43673 |
| | 26 | 43651 | | 1202 | 43663 | | 1213 | 43674 |
| | 32 | 43652 | | 1203 | 43664 | | 1214 | 43675 |
| | 36 | 43653 | | 1204 | 43665 | | 1215 | 43676 |
| | 39 | 43654 | | 1205 | 43666 | | 1216 | 43677 |
| | 40 | 43655 | | 1206 | 43667 | | 1217 | 43678 |

euro/m

individually packed

UNISYSTEM PLUS

length = 270 cm - pack 10 pcs - for floor thicknesses from 6,5 to 12,5 mm

ART. finishing

ANODISED ALUMINIUM

| | | | | |
|---------------|----------|--|--|-------|
| | silver | | | 43690 |
| G/2/SF | euro/m | | | |
| | titanium | | | 43691 |
| | euro/m | | | |

individually packed

UNISYSTEM PLUS - BASES

floor thickness from / to mm 6,5/10 9,6/12,5

length = 270 cm - pack 20 pcs (15 clips TU/6 included)

ART. finishing 6 10 H

ALUMINIUM

| | | | | |
|-------------|-------------------|--|-------|-------|
| TPU/ | natural aluminium | | 67437 | 67447 |
| | euro/m | | | |

individually packed

SPARE CLIPS

pack 150 pcs H

TU/6 6

TU/6 68812/150

euro/pack

no partial packaging

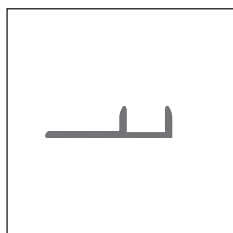

TPU/

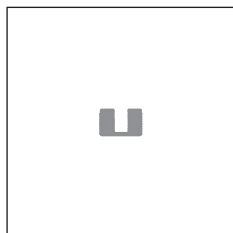

TU/6

Customized PDS decors on request, see page 191

Profiles of 270 cm length: please order the base separately.

G/4/SF is a stair nosing profile of Unisystem Plus range, composed of a base and a top profile, for the floating installation of wooden and laminate floors with thicknesses from 6,5 to 15,5 mm.



G/4/SF aluminium covered with Alcrom® Plus film

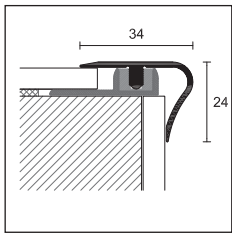

G/4/SF + TPU/



UNISYSTEM PLUS

length = 270 cm - pack 10 pcs - for floor thicknesses from 6,5 to 15,5 mm

ART. finishing

ALUMINIUM covered with ALCROM® PLUS film

| | | | | | | |
|--------|----|-------|----|-------|----|-------|
| G/4/SF | 02 | 63905 | 37 | 63943 | 76 | 63956 |
| | 08 | 63907 | 38 | 63919 | 77 | 63937 |
| | 10 | 63910 | 40 | 63920 | 78 | 63934 |
| | 11 | 63911 | 41 | 63926 | 79 | 63938 |
| | 12 | 63913 | 42 | 63921 | 80 | 63935 |
| | 13 | 63916 | 43 | 63927 | 81 | 63939 |
| | 18 | 63914 | 44 | 63929 | 92 | 63941 |
| | 20 | 63915 | 65 | 63931 | 93 | 63944 |
| | 32 | 63917 | 71 | 63951 | 94 | 63945 |
| | 34 | 63923 | 72 | 63952 | 95 | 63946 |
| | 35 | 63924 | 73 | 63953 | | |
| | 36 | 63942 | 74 | 63954 | | |

euro/m

individually packed

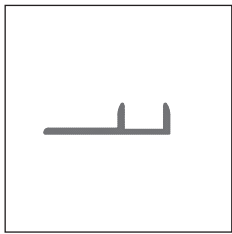

TPU/

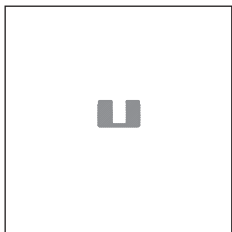

TU/6

UNISYSTEM PLUS

length = 270 cm - pack 10 pcs - for floor thicknesses from 6,5 to 15,5 mm

ART. finishing

ANODISED ALUMINIUM

| | | | |
|--------|-----------|--|-------|
| G/4/SF | silver | | 63900 |
| | euro/m | | |
| | gold sand | | 63904 |
| | euro/m | | |

individually packed

UNISYSTEM PLUS - BASES

| floor thickness from / to mm | 6,5/10 | 9,6/12,5 | 12,6/15,5 |
|---|----------|-----------|-----------|
| length = 270 cm pack 20 pcs (15 clips TU/6 included) | | H | |
| ART. finishing | 6 | 10 | 13 |
| ALUMINIUM | | | |
| TPU/ natural aluminium | 67437 | 67447 | 67457 |
| euro/m | | | |

individually packed

SPARE CLIPS

| | |
|-----------------|-----------|
| pack da 150 pcs | H |
| | 6 |
| TU/6 | 68812/150 |

euro/pack

no partial packaging

Profiles of 270 cm length: please order the base separately.

Customized PDS decors on request, see page 191

profix thin

Profix Thin is a system designed to allow the expansion of Click LVT floors, also suitable for loose-lay LVT floors. Profix Thin is suitable for floors from 4 to 8 mm thick and is composed of junction profiles for same level floors (Z/4), connection profiles for different level floors (C/4) and perimetral profiles (S/4). The system is composed of PVC base and a top profile available in different finishes of anodised aluminium or covered with wood-, stone- or concrete-effect Alcrom® Plus film for matching the floor perfectly.

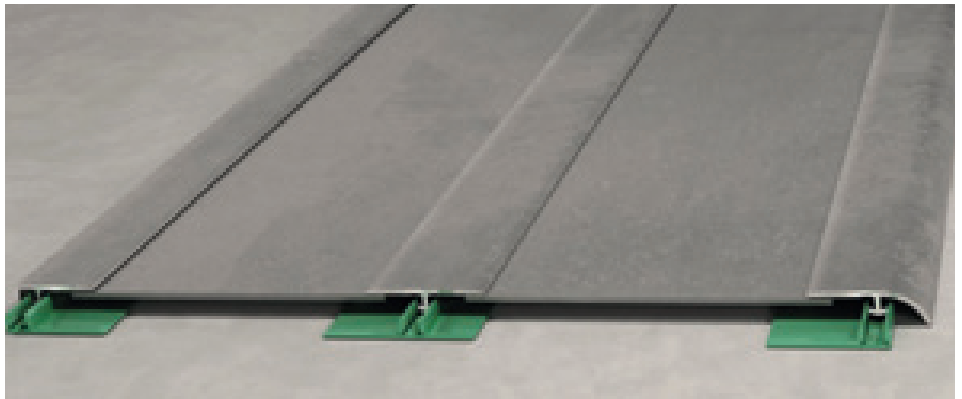

Profix Thin S/4, Z/4 and C/4

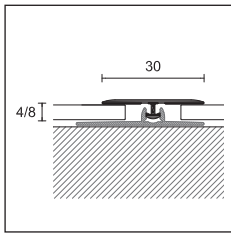

Z/4 + PT/4

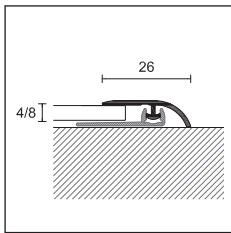

C/4 + PT/4/SA

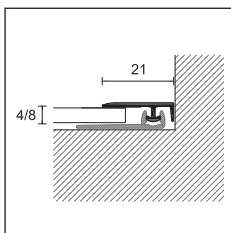

S/4 + PT/4/SA

PROFIX THIN

length = 270 cm - pack 20 pcs

for floor thickness (from 4 to 8 mm)

ALUMINIUM covered with ALCROM® PLUS film

| | Z/4 | C/4 | S/4 |
|------|-------|-------|-------|
| 1003 | 85101 | 85201 | 85301 |
| 1006 | 85102 | 85202 | 85302 |
| 1009 | 85103 | 85203 | 85303 |
| 1012 | 85104 | 85204 | 85304 |
| 1021 | 85107 | 85207 | 85307 |
| 1024 | 85108 | 85208 | 85308 |
| 1030 | 85110 | 85210 | 85310 |
| 1033 | 85111 | 85211 | 85311 |
| 1036 | 85112 | 85212 | 85312 |
| 1042 | 85114 | 85214 | 85314 |
| 1045 | 85115 | 85215 | 85315 |
| 1051 | 85117 | 85217 | 85317 |
| 1054 | 85118 | 85218 | 85318 |
| 1057 | 85119 | 85219 | 85319 |
| 1060 | 85120 | 85220 | 85320 |
| 1063 | 85121 | 85221 | 85321 |
| 1066 | 85122 | 85222 | 85322 |
| 1069 | 85123 | 85223 | 85323 |
| 1081 | 85127 | 85227 | 85327 |
| 1084 | 85128 | 85228 | 85328 |
| 1090 | 85130 | 85230 | 85330 |
| 1105 | 85135 | 85235 | 85335 |
| 1108 | 85136 | 85236 | 85336 |
| 1111 | 85137 | 85237 | 85337 |





euro/m

individually packed

PROFIX THIN

length = 270 cm - pack 20 pcs

for floor thickness (from 4 to 8 mm)

| ART. | Z/4 | C/4 | S/4 |
|---------------------------|---|-------|-------|
| finishing | | | |
| ANODISED ALUMINIUM | | | |
| silver |  85050 | 85060 | 85070 |
| euro/m | | | |
| gold sand |  85052 | 85062 | 85072 |
| titanium |  85054 | 85064 | 85074 |
| euro/m | | | |
| bronze elox |  85056 | 85066 | 85076 |
| euro/m | | | |

Customized PDS decors on request, see page 191

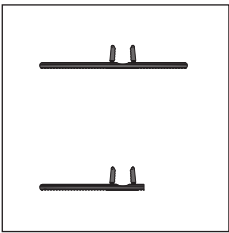

PT/4
PT/4/SA

PROFIX THIN - BASES

length = 270 cm - pack 20 pcs

for floor thickness (from 4 to 6 mm)

| ART. | PT/4 | PT/4/SA |
|-----------|---|---------|
| finishing | | |
| PVC | | |
| green |  | 85081 |
| euro/m | | 85083 |

To order PT/4 and PT/4/SA in pack of 100 pcs mark /100 after the article code (for example code 85081 becomes 85081/100). Pack of 100 pcs of PT/4 and PT/4/SA €/m

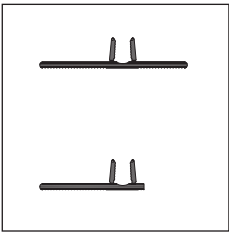

PT/6
PT/6/SA

PROFIX THIN - BASES

length = 270 cm - pack 20 pcs

for floor thickness (from 6 to 8 mm)

| ART. | PT/6 | PT/6/SA |
|-----------|---|---------|
| finishing | | |
| PVC | | |
| green |  | 85086 |
| euro/m | | 85088 |

To order PT/6 and PT/6/SA in pack of 100 pcs mark /100 after the article code (for example code 85086 becomes 85086/100). Pack of 100 pcs of PT/6 and PT/6/SA €/m

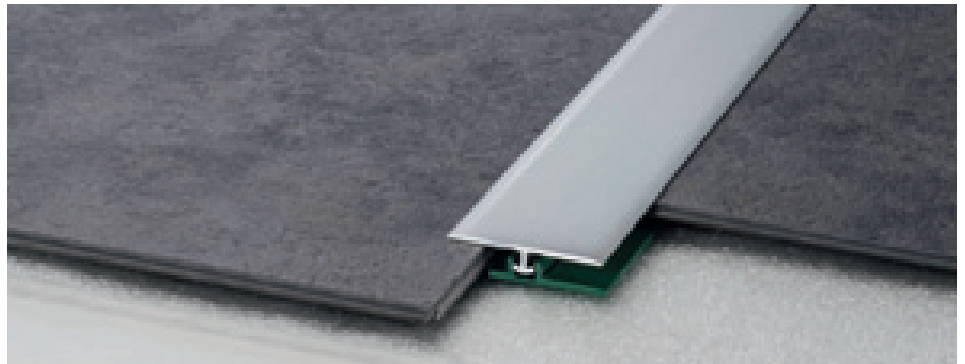

Z/4 + PT/4

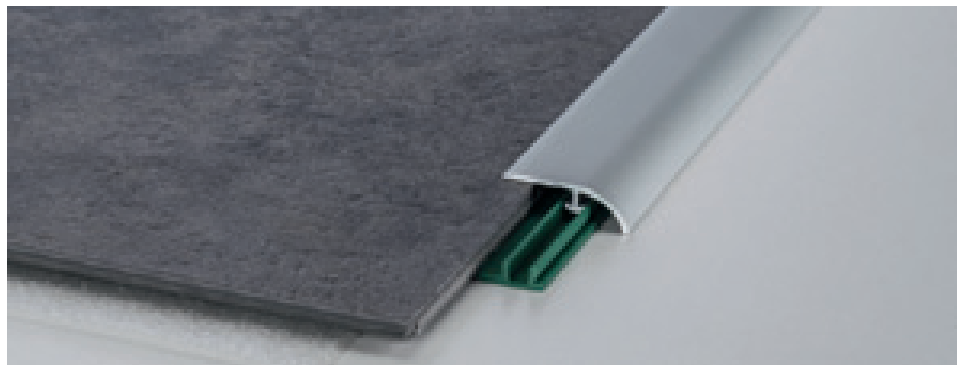

C/4 + PT/4/SA

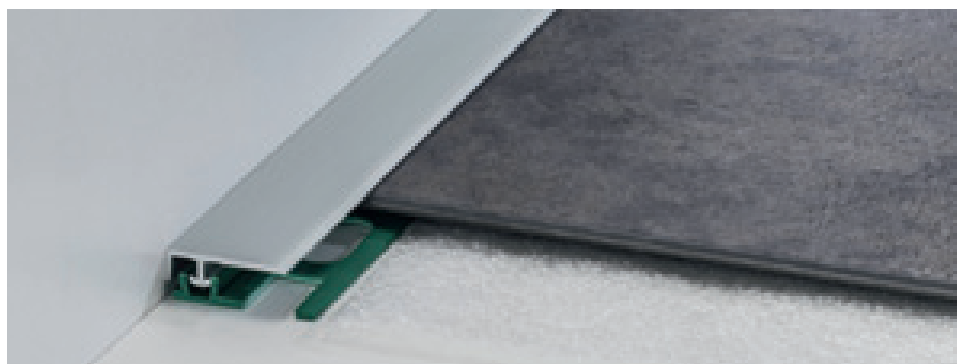

S/4 + PT/4/SA

prestowood

Prestowood 22/A, 50/A and 63/A are adhesive profiles for wooden floors of same level, different level and stairs that have been already installed. In anodised aluminium, or covered with Alcrom® Plus film, they are particularly easy and quick to install, thus becoming suitable also for the DIY.



22/A aluminium covered with Alcrom® Plus film

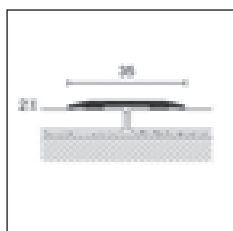

422/AD
22/A

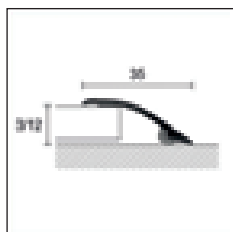

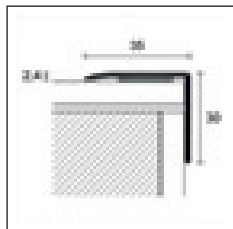

450/AD
50/A





































63/A



PRESTOWOOD

| pack | 10 pcs / blister  | 10 pcs | 10 pcs / blister  | 10 pcs | 10 pcs |
|-----------|--|-------------|--|-------------|-------------|
| length cm | 90 | 270 | 90 | 270 | 270 |
| ART. | 422/AD | 22/A | 450/AD | 50/A | 63/A |

ALUMINIUM covered with ALCROM® PLUS film

| | | | | | | |
|---|------|-------|-------|-------|-------|-------|
|  | 05 | 43700 | 43932 | 44949 | 45031 | 45140 |
|  | 08 | 43701 | 43933 | 44950 | 45032 | 45141 |
|  | 12 | 43702 | 43934 | 44951 | 45033 | 45142 |
|  | 13 | 43703 | 43935 | 44952 | 45034 | 45143 |
|  | 14 | 43704 | 43936 | 44953 | 45035 | 45144 |
|  | 19 | 43705 | 43937 | 44954 | 45036 | 45145 |
|  | 26 | 43706 | 43938 | 44955 | 45037 | 45146 |
|  | 31 | 43707 | 43939 | 44956 | 45038 | - |
|  | 32 | 43708 | 43940 | 44957 | 45039 | 45147 |
|  | 34 | 43709 | 43941 | 44958 | 45040 | - |
|  | 36 | 43710 | 43942 | 44959 | 45041 | 45148 |
|  | 39 | 43711 | 43943 | 44960 | 45042 | 45149 |
|  | 40 | 43712 | 43944 | 44961 | 45043 | 45150 |
|  | 41 | 43713 | 43945 | 44962 | 45044 | 45151 |
|  | 73 | 43714 | 43946 | 44963 | 45045 | - |
|  | 74 | 43715 | 43947 | 44964 | 45046 | - |
|  | 77 | 43716 | 43948 | 44965 | 45047 | 45152 |
|  | 79 | 43717 | 43949 | 44966 | 45048 | - |
|  | 81 | 43718 | 43950 | 44967 | 45049 | - |
|  | 89 | 43719 | 43951 | 44968 | 45050 | 45153 |
|  | 91 | 43720 | 43952 | 44969 | 45051 | 45154 |
|  | 92 | 43721 | 43953 | 44970 | 45052 | - |
|  | 93 | 43762 | 43995 | 45013 | 45094 | 45155 |
|  | 94 | 43722 | 43954 | 44971 | 45053 | - |
|  | 351 | 43723 | 43955 | 44972 | 45054 | - |
|  | 363 | 43724 | 43956 | 44973 | 45055 | - |
|  | 372 | 43725 | 43957 | 44974 | 45056 | - |
|  | 490 | 43727 | 43959 | 44976 | 45058 | - |
|  | 560 | 43728 | 43960 | 44977 | 45059 | - |
|  | 580 | 43729 | 43961 | 44978 | 45060 | 45156 |
|  | 590 | 43730 | 43962 | 44979 | 45061 | - |
|  | 665 | 43731 | 43963 | 44980 | 45062 | - |
|  | 670 | 43732 | 43964 | 44981 | 45063 | - |
|  | 951 | 43738 | 43970 | 44987 | 45069 | - |
|  | 975 | 43739 | 43971 | 44988 | 45070 | - |
| | 1024 | 43740 | 43972 | 44989 | 45071 | - |
| | 1033 | 43741 | 43973 | 44990 | 45072 | - |
| | 1042 | 43742 | 43974 | 44991 | 45073 | - |
| | 1090 | 43744 | 43976 | 44993 | 45075 | - |

 packaging in blister no partial packaging

Customized PDS decors on request, see page 191



| pack | 10 pcs/blister | 10 pcs | 10 pcs/blister | 10 pcs | 10 pcs | |
|---|----------------|-------------|----------------|-------------|-------------|-------|
| length cm | 90 | 270 | 90 | 270 | 270 | |
| ART. | 422/AD | 22/A | 450/AD | 50/A | 63/A | |
| ALUMINIUM covered with ALCROM® PLUS film | | | | | | |
| | 1202 | 43746 | 43978 | 44995 | 45077 | 45158 |
| | 1203 | 43747 | 43979 | 44996 | 45078 | 45159 |
| | 1204 | 43748 | 43980 | 44997 | 45079 | 45160 |
| | 1205 | 43749 | 43981 | 44998 | 45080 | 45161 |
| | 1206 | 43750 | 43982 | 44999 | 45081 | 45162 |
| | 1207 | 43751 | 43983 | 45000 | 45082 | 45163 |
| | 1208 | 43752 | 43984 | 45001 | 45083 | 45164 |
| | 1209 | 43753 | 43985 | 45002 | 45084 | 45165 |
| | 1210 | 43754 | 43986 | 45003 | 45085 | 45166 |
| | 1211 | 43755 | 43987 | 45004 | 45086 | 45167 |
| | 1212 | 43756 | 43988 | 45005 | 45087 | 45168 |
| | 1213 | 43757 | 43989 | 45007 | 45088 | 45169 |
| | 1214 | 43758 | 43990 | 45008 | 45089 | 45170 |
| | 1215 | 43759 | 43991 | 45009 | 45090 | 45171 |
| | 1216 | 43760 | 43992 | 45010 | 45091 | 45172 |
| | 1217 | 43761 | 43993 | 45011 | 45092 | 45173 |
| | 100 | - | 43994 | - | 45093 | - |
| | black 97 | - | 43996 | - | 45095 | 45175 |
| euro/pc | | | - | | - | - |
| euro/m | | | - | | - | - |

individually packed

PROCLASSIC F / PROLEVEL HIGH / PROTECT

| pack | 10 pcs/blister | 10 pcs | 10 pcs/blister | 10 pcs | 10 pcs | |
|---------------------------|----------------|-------------|----------------|-------------|-------------|-------|
| length cm | 90 | 270 | 90 | 270 | 270 | |
| ART. | 422/AD | 22/A | 450/AD | 50/A | 63/A | |
| ANODISED ALUMINIUM | | | | | | |
| | silver | 43790 | 44000 | 45019 | 45100 | 45190 |
| euro/pc | | | - | | - | - |
| euro/m | | | - | | - | - |
| | titanium | 43791 | 44001 | 45020 | 45101 | 45191 |
| euro/pc | | | - | | - | - |
| euro/m | | | - | | - | - |

individually packed



50/A titanium anodised aluminium



63/A silver anodised aluminium

prestowood

Prestowood 74/A is a line of stair nosing profiles covered with wood-effect Alcrom® Plus film, for the protection of already-laid wooden step edges. Available in adhesive version, they are particularly recommended for DIY installations.

74/ is also available in different finishes of anodised aluminium, as the stair nosing profiles 73/ and 58/.



74/A aluminium covered with Alcrom® Plus film

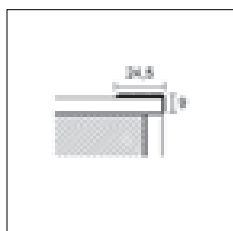

73/

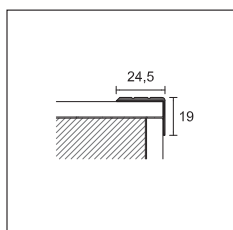

74/

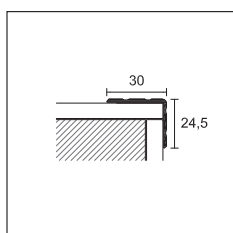

58/A

PRESTOWOOD

| | |
|-------------|-------------|
| pack | 10 pcs |
| length cm | 270 |
| ART. | 74/A |

finishing





ALUMINIUM covered with ALCROM® PLUS film

| | |
|----|-------|
| 10 | 75319 |
| 12 | 75297 |
| 13 | 75301 |
| 20 | 75320 |
| 32 | 75303 |
| 36 | 75304 |
| 37 | 75305 |
| 38 | 75306 |
| 40 | 75322 |
| 47 | 75307 |
| 65 | 75294 |
| 71 | 75309 |
| 76 | 75334 |
| 78 | 75311 |
| 80 | 75326 |
| 92 | 75312 |
| 94 | 75313 |
| 95 | 75314 |

euro/m

individually packed

PROTECT

| | | | | | | | | |
|-------------------|---|-----------|----------|------------|-----------|----------|------------|--|
| pack | 30 pcs | | | | | | 20 pcs | |
| length cm | 270 | | | | | | | |
| ART. | 73/ | | | 74/ | | | 58/ | |
| finishing | F | SF | A | F | SF | A | A | |
| ALUMINIUM | | | | | | | | |
| silver anodised |  75208 | 75209 | 75238 | 75268 | 75269 | 75298 | 75900 | |
| euro/m | | | | | | | | |
| gold anodised |  75218 | - | 75248 | 75278 | - | 75308 | - | |
| euro/m | | | | | | | | |
| bronze anodised |  - | - | 75258 | - | - | 75318 | - | |
| euro/m | | | | | | | | |
| titanium anodised |  | | | | | | 75299 | |
| euro/m | | | | | | | | |

RC is a line of edge profiles for the floating installation of wooden and laminate floors, available in different finishes of anodised aluminium or covered with wood-effect Alchrom® Plus film. This profile is also available in the bendable version RCF that can be curved with the specific Proflex Machine.

Prolevel High 732/ is a line of profiles for the protection of the perimetral border of wooden and laminate floors.



RC/9/F silver anodised aluminium

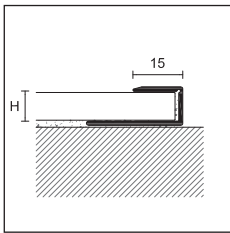

RC/ /F
RCF/



RCF/ silver anodised aluminium

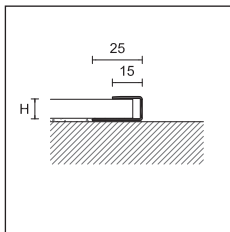

732/SF/



Complete the article code with H measure (for example RC/ /F for H = 9 becomes RC/9/F)

Customized PDS decors on request, see page 191

TERMINAL RC

length = 270 cm - pack 20 pcs

| ART. | finishing | 7 | 9 | 11 | 13 | 15 | |
|------------------|-----------------|---|-------|-------|-------|-------|-------|
| ALUMINIUM | | | | | | | |
| | silver anodised | | 67407 | 67477 | 67547 | 67617 | 67687 |
| | <i>euro/m</i> | | | | | | |
| RC/ /F | gold anodised | | - | 67487 | - | - | - |
| | <i>euro/m</i> | | - | - | - | - | - |
| | bronze anodised | | - | 67497 | - | - | - |
| | <i>euro/m</i> | | - | - | - | - | - |

length = 270 cm - pack 10 pcs

| ART. | finishing | 7 | 9 | 11 | 13 | 15 |
|---|---------------|----|---|-------|----|----|
| ALUMINIUM covered with ALCROM® PLUS film | | | | | | |
| | | | | H | | |
| | | 10 | - | 66731 | - | - |
| | | 20 | - | 66734 | - | - |
| | | 38 | - | 66739 | - | - |
| RC/ /F | | 40 | - | 66740 | - | - |
| | | 42 | - | 66758 | - | - |
| | | 65 | - | 66747 | - | - |
| | | 78 | - | 66751 | - | - |
| | | 80 | - | 66752 | - | - |
| | <i>euro/m</i> | | - | - | - | - |

TERMINAL RC

length = 90 cm - pack 10 pcs / blister

| ART. | finishing | 7 | 9 | 11 | 15 | |
|------------------|-----------------|---|-------|-------|-------|-------|
| ALUMINIUM | | | | | | |
| | silver anodised | | 42782 | 41832 | 41877 | 42822 |
| | <i>euro/pc</i> | | | | | |
| | gold anodised | | - | 41839 | - | - |
| | <i>euro/pc</i> | | - | - | - | - |

TERMINAL RC FLEX

length = 270 cm - pack 10 pcs

| ART. | finishing | 9 | 11 | |
|---------------------|-----------------|---|-------|-------|
| ALUMINIUM | | | | |
| RCF/ | silver anodised | | 67712 | 67714 |
| | <i>euro/m</i> | | | |
| individually packed | | | | |

PROLEVEL HIGH

length = 270 cm - pack 15 pcs

| ART. | finishing | 10 | 12,5 | |
|------------------------|---|----|-------|-------|
| STAINLESS STEEL | | | | |
| 732/SF/ | polished stainless steel AISI 430 DIN 1.4016 | | 74217 | 74227 |
| | <i>euro/m</i> | | | |
| individually packed | | | | |

alfix 616

Alfix 616 is a professional system for the laying of wooden and laminate floors with thickness from 6 to 16 mm. The system is composed of a top profile in anodised aluminium fixed with screws on a natural aluminium base. The screws, included in the packaging, have the same colour of the top profile in order to perfectly match it.



FIX/L/55 silver anodised aluminium

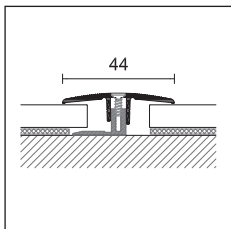

FIX/J/44







ALFIX 616

| | | | |
|-----------|--------|--|-----|
| pack | 10 pcs | 10 pcs / blister  | |
| length cm | 270 | 90 | 100 |

ART. FIX/J/44

for floor thicknesses from 6 to 16 mm

| | | | |
|----------------------|---|-------|-------------|
| finishing | | | |
| ALUMINIUM | | | |
| silver anodised |  | 37010 | 37012 37014 |
| sand gold anodised |  | 37210 | 37212 - |
| euro/m | | | - - |
| euro/pc | | - | |
| titanium anodised |  | 37410 | - 37414 |
| elox bronze anodised |  | 37310 | 37312 37314 |
| euro/m | | | - - |
| euro/pc | | - | |

individually packed

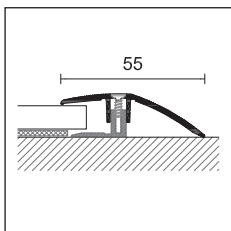





FIX/L/55

ALFIX 616

| | | | |
|-----------|--------|--|-----|
| pack | 10 pcs | 10 pcs / blister  | |
| length cm | 270 | 90 | 100 |

ART. FIX/L/55

for floor thicknesses from 6 to 16 mm

| | | | |
|----------------------|---|-------|-------------|
| finishing | | | |
| ALUMINIUM | | | |
| silver anodised |  | 37040 | 37042 37044 |
| sand gold anodised |  | 37240 | 37242 37244 |
| euro/m | | | - - |
| euro/pc | | - | |
| titanium anodised |  | 37440 | 37442 37444 |
| elox bronze anodised |  | 37340 | - - |
| euro/m | | | - - |
| euro/pc | | - | |

individually packed

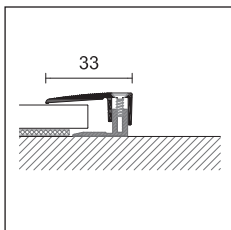





FIX/T/33

ALFIX 616

| | | | |
|-----------|--------|--|-----|
| pack | 10 pcs | 10 pcs / blister  | |
| length cm | 270 | 90 | 100 |

ART. FIX/T/33

for floor thicknesses from 6 to 16 mm

| | | | |
|----------------------|---|-------|---------|
| finishing | | | |
| ALUMINIUM | | | |
| silver anodised |  | 37070 | - 37074 |
| sand gold anodised |  | 37270 | 37272 - |
| euro/m | | | - - |
| euro/pc | | - | |
| titanium anodised |  | 37470 | - 37474 |
| elox bronze anodised |  | - | - 37374 |
| euro/m | | | - - |
| euro/pc | | - | |

individually packed

 packaging in blister no partial packaging

Alfix 46 is a professional system designed to allow the expansion of Click LVT floors, also suitable for loose-lay LVTs. This system is characterized by top profiles in anodised aluminium, fixed with a screw system on a natural aluminium base. Screws, included in the package, have the same colour of the anodisation and, once fixed, integrate with the top profile.



FIX/J/30 silver anodised aluminium



FIX/L/32 silver anodised aluminium



FIX/T/19 silver anodised aluminium

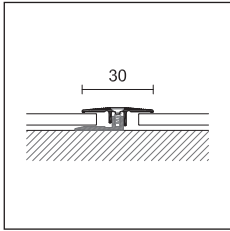

FIX/J/30

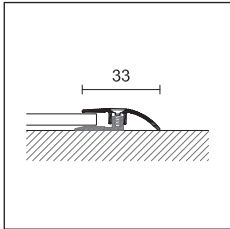

FIX/L/32

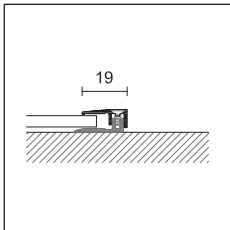

FIX/T/19

ALFIX 46

| | |
|-----------|--------|
| pack | 10 pcs |
| length cm | 270 |

ART. FIX/J/30

for floor thicknesses from 4 to 6 mm

finishing

ALUMINIUM

| | | |
|-----------------|--|-------|
| silver anodised | | 35500 |
|-----------------|--|-------|

euro/m

individually packed

ALFIX 46

| | |
|-----------|--------|
| pack | 10 pcs |
| length cm | 270 |

ART. FIX/L/32

for floor thicknesses from 4 to 6 mm

finishing

ALUMINIUM

| | | |
|-----------------|--|-------|
| silver anodised | | 35510 |
|-----------------|--|-------|

euro/m

individually packed

ALFIX 46

| | |
|-----------|--------|
| pack | 10 pcs |
| length cm | 270 |

ART. FIX/T/19

for floor thicknesses from 4 to 6 mm

finishing

ALUMINIUM

| | | |
|-----------------|--|-------|
| silver anodised | | 35520 |
|-----------------|--|-------|

euro/m

individually packed

cerfix® projoint DIL - pronivel

NZA/ is a dynamic expansion joint in aluminium composed of two interlocking sliding profiles. Suitable for Click LVT floors, it guarantees a good resistance to loads and intense foot traffic. Thanks to the exclusive solution with adhesive integrated into the internal anchor flange, it can be fixed directly to the plank and it is the perfect expansion joint for Click LVT floors with uninterrupted and perfectly flat surface.



NZA/5A silver anodised aluminium

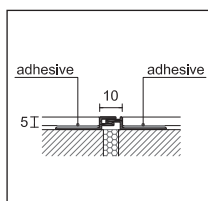

NZA/5A



PROJOINT DIL

length = 270 cm - pack 20 pcs

| | | |
|------------------|----------------------|-----------|
| ART. | finishing | 5A |
| ALUMINIUM | | |
| | silver anodised | 99310 |
| | <i>euro/m</i> | |
| NZA/ | titanium anodised | 99314 |
| | elox bronze anodised | 99316 |
| | <i>euro/m</i> | |

individually packed

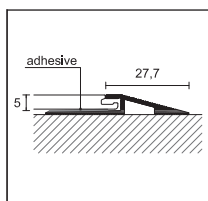

PBA/5/A



PRONIVEL PB

length = 270 cm - pack 10 pcs

| | | |
|------------------|------------------|----------|
| ART. | finishing | H |
| ALUMINIUM | | |
| PBA/5/A | silver anodised | 93205 |
| | <i>euro/m</i> | |

individually packed

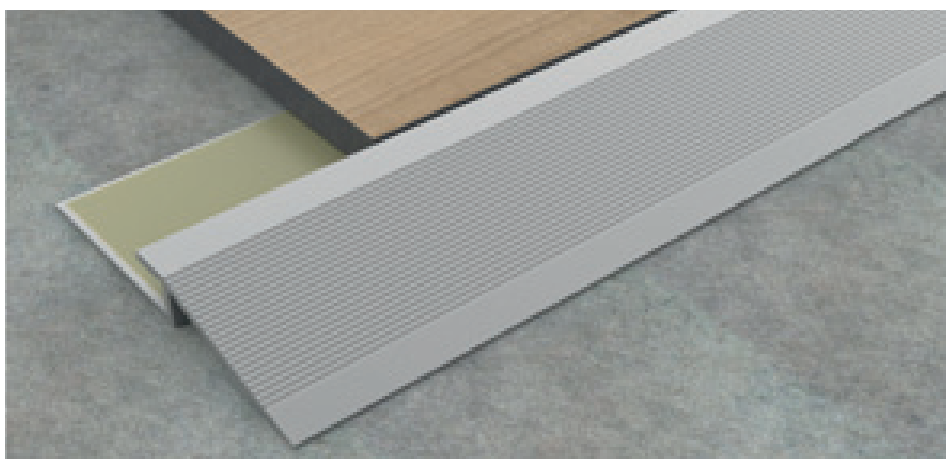

PBA/5A silver anodised aluminium

cerfix® projoint - pronivel

H/5/F, PBAS/5/F, RC/5/F and 99/TR/26 are connection profiles in anodised aluminium, for floating Click LVT floors and suitable as profiles for same height, different height and for borders.

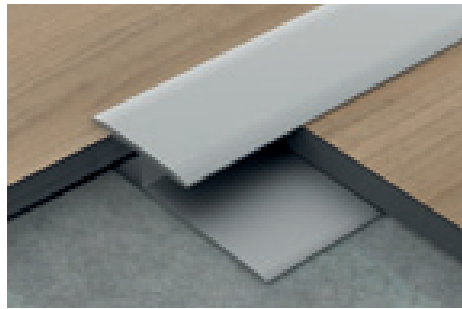

H/5/F silver anodised aluminium



PBAS/5/S silver anodised aluminium

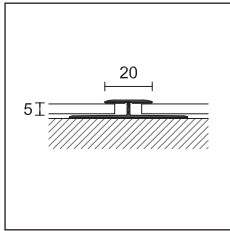

H/5/F



PROJOINT T

length = 270 cm - pack 20 pcs

H

ART. finishing

5

ALUMINIUM

H/5/F drilled silver anodised



75000

euro/m

individually packed

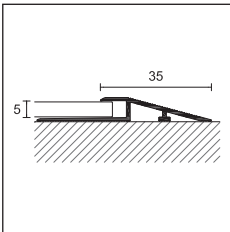

PBAS/5/F



PRONIVEL PB

length = 270 cm - pack 20 pcs

H

ART. finishing

5

ALUMINIUM

PBAS/5/F drilled silver anodised



95203

euro/m

individually packed

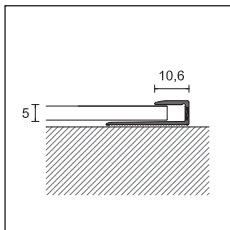

RC/5/F



TERMINAL RC

length = 270 cm - pack 20 pcs

H

ART. finishing

5

ALUMINIUM

RC/5/F drilled silver anodised



67475

euro/m

individually packed

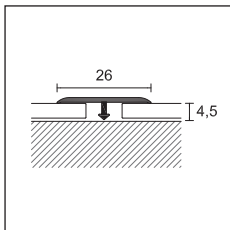

99/TR/26



PROJOINT T

length = 270 cm - pack 20 pcs

LxH

ART. finishing

26 x 4,5

ALUMINIUM

99/TR/26 silver anodised



75081

euro/m

individually packed

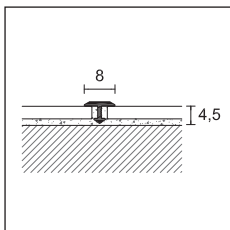

99/T/8



PROJOINT T

length = 270 cm - pack

50 pcs

width

8

ART. finishing

ALUMINIUM

99/T/ silver anodised



75075

euro/m

length = 270 cm - pack

50 pcs

BRASS

399/T/ polished



75070

euro/m

pack

30 pcs

399/TC/ chromium plated



75071

euro/m

individually packed

proststep - protect

SMA/, 75/F, 111/ /F and G/705/F are profiles in anodised aluminium suitable for stairs covered glue-down or loose-lay LVT.
ZGF/ is a profile in aluminium suitable for following the curvilinear course of stair or floors in glue-down or loose-lay LVT.



SMA/4 silver anodised aluminium

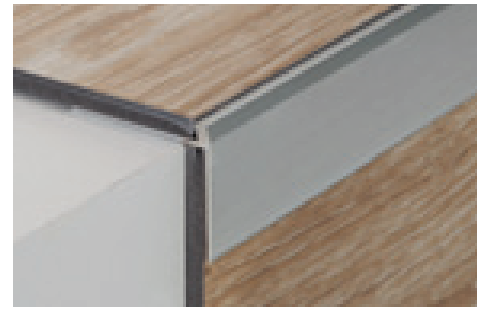

75/F silver anodised aluminium

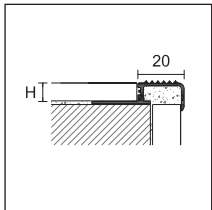

SMA/4



PROSTEP

length = 270 cm - pack 10 pcs

H

ART. finishing

4,5

ALUMINIUM

SMA/ natural aluminium

93967

euro/m

SMA/ silver anodised

93975

euro/m

individually packed

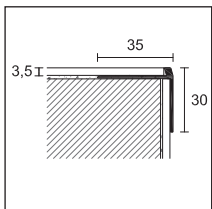

75/F



PROTECT

length = 340 cm - pack 20 pcs

H

ART. finishing

3,5

ALUMINIUM

75/F silver anodised

75388

euro/m

PROTECT

length = 270 cm - pack 20 pcs

H

ART. finishing

2,5

4,5

5

ALUMINIUM

111/ /F silver anodised

75782

75784

75785

euro/m

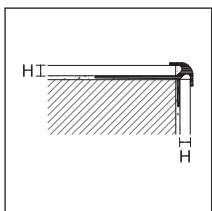

111/

PROSTEP

length = 270 cm - pack 10 pcs

H

ART. finishing

5

ALUMINIUM

G/705/F silver anodised

67580

euro/m

individually packed

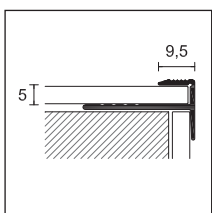

G/705/F

PRO FLEX LINE



PROANGLE FLEX

length = 270 cm - pack 10 pcs

H

ART. finishing

4,5

ALUMINIUM

ZGF/ natural aluminium

88721

euro/m

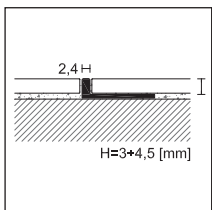

ZGF/



111/2,5/F silver anodised aluminium



G/705/F silver anodised aluminium

cerfix® protrim - proangle

RA/ and RI/ are profiles that are suitable for glue-down or loose-lay LVT floors and are recommended as border profiles for floors or stairs finishing.

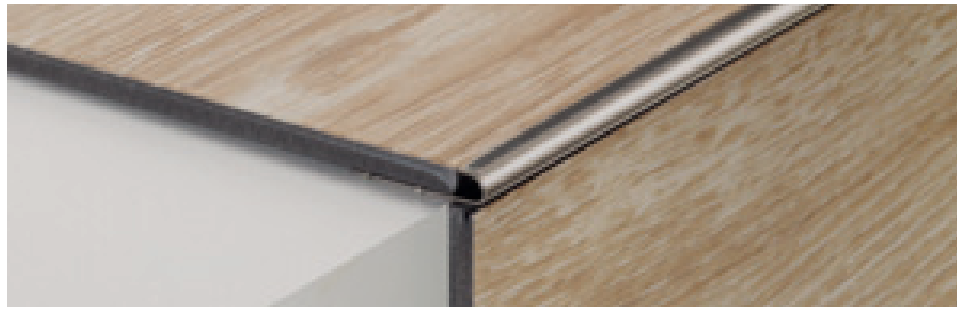

RI/4 stainless steel AISI 304 - DIN 1.4301

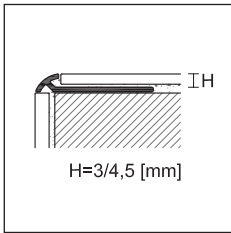

RA/

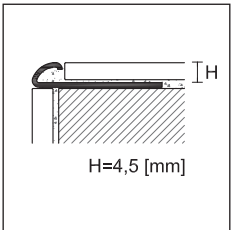

RI/

PROTRIM

length = 270 cm - pack 20 pcs

| ART. | finishing | 3 | H | 4,5 |
|------|-----------|---|---|-----|
|------|-----------|---|---|-----|

ALUMINIUM

| | | | |
|-----------------|--|-------|-------|
| silver anodised | | 92055 | 92056 |
|-----------------|--|-------|-------|

euro/m

| | | | |
|---------------|--|-------|-------|
| gold anodised | | 92025 | 92026 |
|---------------|--|-------|-------|

euro/m

| | | | |
|-------------------|--|-------|-------|
| titanium anodised | | 92085 | 92086 |
|-------------------|--|-------|-------|

euro/m

individually packed

PROTRIM

length = 270 cm - pack 20 pcs

| ART. | finishing | 4,5 | H |
|------|-----------|-----|---|
|------|-----------|-----|---|

STAINLESS STEEL

| | | | |
|-----|-------------------------------------|--|-------|
| RI/ | stainless steel AISI 304 DIN 1.4301 | | 92413 |
|-----|-------------------------------------|--|-------|

euro/m

individually packed

ZA/, AI/, ZQAN/ and ZQKN/ are profiles suitable for glue-down or loose-lay LVT and are recommended as connection and border profiles.



ZA/4 silver anodised aluminium

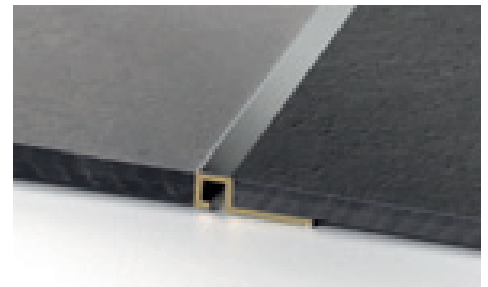

ZQKN/4 chromium-plated brass

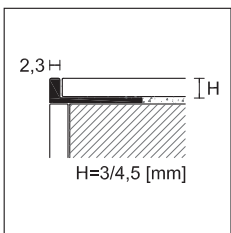

ZA/

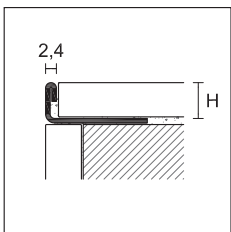

AI/

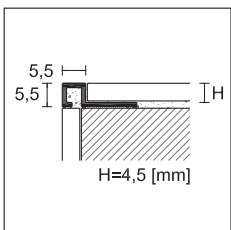

ZQAN/
ZQKN/

PROANGLE

length = 270 cm - pack 20 pcs

| ART. | finishing | 2,5 | 3 | 4,5 | H |
|------|-----------|-----|---|-----|---|
|------|-----------|-----|---|-----|---|

ALUMINIUM

| | | | | | |
|-----|-----------------|--|-------|-------|-------|
| ZA/ | silver anodised | | 90337 | 90338 | 90340 |
|-----|-----------------|--|-------|-------|-------|

euro/m

STAINLESS STEEL

| | | | | | |
|-----|-------------------------------------|--|---|-------|-------|
| AI/ | stainless steel AISI 304 DIN 1.4301 | | - | 91636 | 91638 |
|-----|-------------------------------------|--|---|-------|-------|

euro/m

individually packed - version chromium - plated brass article ZK/4,5 see page 29

PROANGLE Q

length = 270 cm - pack 20 pcs

| ART. | finishing | 4,5 | H |
|------|-----------|-----|---|
|------|-----------|-----|---|

ALUMINIUM

| | | |
|-----------------|--|-------|
| silver anodised | | 88772 |
|-----------------|--|-------|

euro/m

| | | |
|-------------------|--|-------|
| titanium anodised | | 88902 |
|-------------------|--|-------|

euro/m

BRASS

| | | | |
|-------|-----------------|--|-------|
| ZQKN/ | chromium plated | | 88870 |
|-------|-----------------|--|-------|

euro/m

individually packed

cerfix® proround

GA/, JGA/ and PIA/ are connection profiles for stairs in glue-down or loose-lay LVT floors. Easy to lay, they facilitate the hygienic maintenance of the connection between tread and riser.



GA/4 silver anodised aluminium



JGA/4 silver anodised aluminium

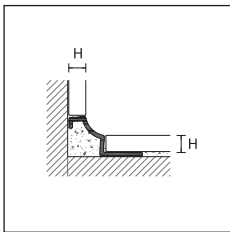

GA/



PROROUND M

length = 270 cm - pack 20 pcs

ART. finishing **4,5**

ALUMINIUM

GA/ silver anodised  95730

euro/m

individually packed

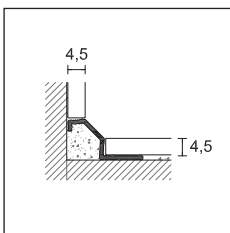

JGA/

PROROUND M

length = 270 cm - pack 20 pcs

ART. finishing **4,5**

ALUMINIUM

JGA/ silver anodised  95732

euro/m

individually packed

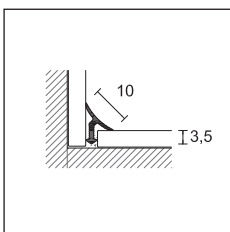

PIA/



PROINT

length = 270 cm - pack 20 pcs

ART. finishing **3,5**

ALUMINIUM

PIA/ silver anodised  95431

euro/m

individually packed



PIA/3 silver anodised aluminium

PVC Line skirting boards for wooden, laminate and LVT floors



PVC Line 8605 covered with Alcrom® Plus film, see page 212



PVC Line 8608 covered with Alcrom® Plus film, see page 213



PVC Line 8615 covered with Alcrom® Plus film, see page 214



PVC Line 8613 covered with Alcrom® Plus film, see page 215



PVC Line 8612 covered with Alcrom® Plus film, see page 216



PVC Line 8614 covered with Alcrom® Plus film, see page 216

Profilpas Digital System no limits to imagination



Profilpas gives the possibility to choose between over 400 standard decors Alcrom® Plus to combine the chosen profile or skirting board with the floor perfectly: indeed, a wide selection of wood, stone or concrete decors is available in our database to meet every need. Just consult our PDS bunch to discover the decor that best suits to your wish of combination.

But that's not all. The possibility of customization is really limitless with Profilpas. We just need to

receive a sample for creating any further decor, even a fantasy one!

This is possible thanks to Profilpas Digital System (PDS), the innovative digital printing technology of Profilpas to reproduce any decor on Alcrom Plus film and not to give limits to imagination! The whole production process is made inside our factory: from the scanner to the printing and the application of the film.

Please note: for customizations with decors that are not in our database, there is an extra of € for decor.

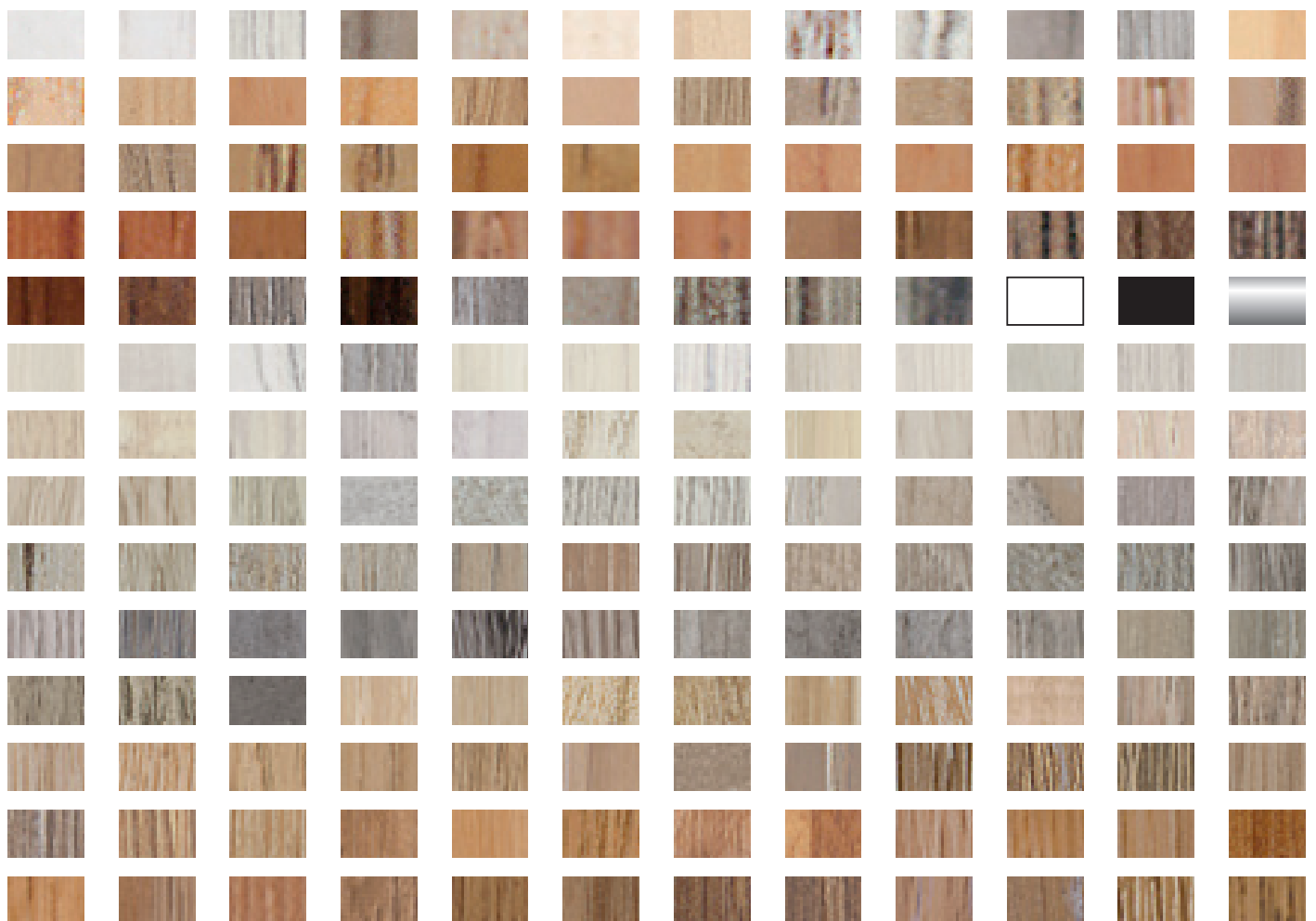



**UNISYSTEM PLUS Z/1, C/7, S/9
PROFIX THIN Z/4, C/4 AND S/4**

| | |
|------------------------------|-----|
| Quantity 20 pcs / 54 m = + | €/m |
| Quantity 40 pcs / 108 m = + | €/m |
| Quantity 60 pcs / 162 m = + | €/m |
| Quantity 80 pcs / 216 m = + | €/m |
| Quantity 100 pcs / 270 m = + | €/m |

min. 54 m

| | |
|------------------------------|-----|
| Quantity 120 pcs / 324 m = + | €/m |
| Quantity 140 pcs / 378 m = + | €/m |
| Quantity 160 pcs / 432 m = + | €/m |
| Quantity 180 pcs / 486 m = + | €/m |
| Quantity 200 pcs / 540 m = + | €/m |

Z3/30, C/10, C/13, C/22 E S/15

min. 540 m divisible into 5 decors

UNISYSTEM PLUS G/2 AND G/4

min. 540 m divisible into 5 decors

22/A, 50/A AND 63/A

min. 540 m divisible into 5 decors

74/A

min. 540 m divisible into 5 decors

RC/ /F

min. 540 m divisible into 5 decors

PVC LINE 8605, 8606, 8608, 8615, 8616, 8612, 8613 AND 8614

min. 540 m divisible into 2 decors

For the customization of other articles, please contact our Sales Department.

Please note: for customizations with decors that are not in our database, there is an extra of € for decor.



WOOD,
LAMINATE, LVT





metal line skirting board

To choose Metal Line means giving importance to details because they are the ones who make the difference. Metal Line is distinguished by its versatility and functionality, but also for its inspiration to contemporary design. It is an innovative line, rich of solutions with a wide variety of combinations and colours capable of satisfying every housing need, from small and large gathering places. Stainless steel and aluminium, materials that give shape, colour and size to the space, minimalist signs that follow the flow of everyday life. Metal Line can provide a continuum of profiles that integrate perfectly into environments and different styles, enhancing their aesthetic and architectural appeal. Metal Line becomes a trend line, thanks to Profilpas research on materials and shapes and to the attention of the company to the world of furniture and design.

skirting board metal line

Metal Line 90 is an aluminium skirting board, available in different finishes, that creates an elegant junction between the wall and the floor. Thanks to the curved section, this skirting board perfectly hides the perimetral expansion gap of a floating floor. Metal Line 90 is also available in white and black Trend Color Stone, two matt colours that perfectly match the most modern ceramic coverings. All the models can be curved through the specific Proflex Machine.

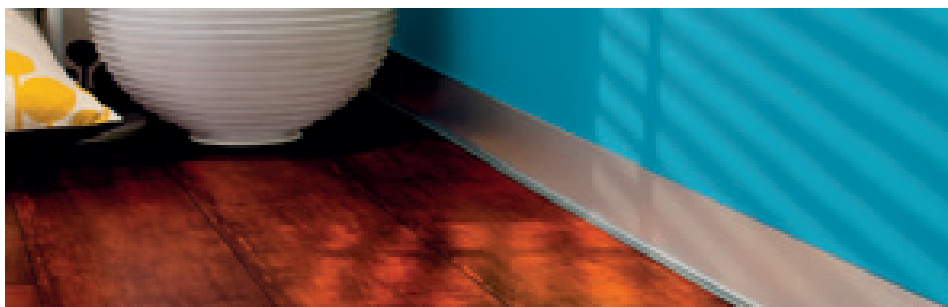

90/10 silver anodised aluminium

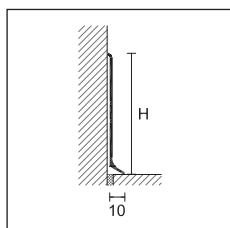

Metal Line 90 white stone colour-coated aluminium



Metal Line 90/6 silver anodised aluminium

TREND
COLOR

METAL LINE 90

length = 200 cm- pack 25 pcs

| | | H cm | | | | | |
|--|--|-------|-------|-------|-------|-------|-------|
| ART. | finishing | 4 | 5 | 6 | 7 | 8 | 10 |
| ALUMINIUM | | | | | | | |
| | silver anodised | 78080 | 78084 | 78100 | 78138 | 78130 | 78137 |
| | <i>euro/m</i> | | | | | | |
| | colour-coated polished white RAL 9010 | - | - | 78112 | - | - | - |
| | colour-coated matt white RAL 9010 | - | - | 78110 | - | - | - |
| | <i>euro/m</i> | - | - | - | - | - | - |
| 90/ SF | titanium anodised | - | - | 78103 | - | - | - |
| | <i>euro/m</i> | - | - | - | - | - | - |
| | colour-coated anthracite grey | - | - | 78118 | - | - | - |
| | colour-coated ancient grey | - | - | 78119 | - | - | - |
| | <i>euro/m</i> | - | - | - | - | - | - |
| 90/ A | self-adhesive silver anodised | - | - | 78106 | - | 78136 | - |
| | <i>euro/m</i> | - | - | - | - | - | - |
| 90/ BSF | bright polished titanium | - | - | 78142 | - | 78149 | - |
| 90/ SSF | bright brushed silver | 78082 | - | 78105 | - | 78133 | - |
| | bright brushed gold | - | - | 78107 | - | 78135 | - |
| | <i>euro/m</i> | - | - | - | - | - | - |
| 90/ TMSF | bright brushed titanium | 78088 | - | 78102 | - | 78134 | - |
| | <i>euro/m</i> | - | - | - | - | - | - |
| TREND COLOR STONE | | | | | | | |
| 90/ SF | colour-coated white stone | - | - | 78094 | - | - | - |
| | colour-coated black stone | - | - | 78099 | - | - | - |
| | <i>euro/m</i> | - | - | - | - | - | - |
| ANTIBACTERIAL COLOUR-COATED ALUMINIUM | | | | | | | |
| 90H/ SF | colour-coated white RAL 9003 antibacterial | - | - | 78104 | - | - | - |
| | <i>euro/m</i> | - | - | - | - | - | - |

individually packed

90/4SF, 90/5SF, 90/6SF and 90/8SF in silver anodised aluminium, available also in length 400 cm

PRO FLEX LINE

Metal Line 90 can be curved by using Proflex Machine + wheels kit for Metal Line 90 (vedi pag 250)

The self-adhesive version in height 4, 5, 7, and 10 is available on request, with a minimum order of 200 meters and a surcharge of

RAL 9003, RAL 7038, RAL 8019, RAL 9006, RAL 9007 colour-coated aluminium skirting boards are available on request, with a minimum order of 300 meters. For other colours, please contact our sales department.

Complete the article code with H measure (for example 90/SF for H=4 becomes 90/4SF)



inside corner, outside corner, junction and right-left end caps

INSIDE CORNER









pack 4 pcs H cm

| ART. | finishing | 4 | 5 | 6 | 7 | 8 | 10 |
|------|-----------|---|---|---|---|---|----|
|------|-----------|---|---|---|---|---|----|

METAL

| | | | | | | | | |
|--|--------|---|-------|-------|-------|-------|-------|-------|
| | silver |  | 78630 | 78640 | 78650 | 78660 | 78670 | 78680 |
|--|--------|---|-------|-------|-------|-------|-------|-------|

euro/pc

| | | | | | | | | |
|---------------|----------------------------|---|-------|---|-------|---|-------|---|
| | titanium |  | - | - | 78654 | - | - | - |
| | polished white RAL 9010 |  | - | - | 78664 | - | - | - |
| | matt white RAL 9010 |  | - | - | 78674 | - | - | - |
| 90/ MI | anthracite grey |  | - | - | 78684 | - | - | - |
| | ancient grey |  | - | - | 78694 | - | - | - |
| | polished titanium |  | - | - | 78700 | - | 78712 | - |
| | brushed silver |  | 78718 | - | 78720 | - | 78722 | - |
| | brushed gold |  | - | - | 78724 | - | 78744 | - |
| | brushed titanium |  | 78714 | - | 78734 | - | 78754 | - |

euro/pc

| | | | | | | | | |
|---------------|-------------|---|---|---|-------|---|---|---|
| 90/ MI | white stone |  | - | - | 78172 | - | - | - |
| | black stone |  | - | - | 78173 | - | - | - |

euro/pc

| | | | | | | | | |
|----------------|------------------------------------|---|---|---|-------|---|---|---|
| 90H/ MI | white RAL 9003 antibacterial |  | - | - | 78690 | - | - | - |
|----------------|------------------------------------|---|---|---|-------|---|---|---|

euro/pc

POLYPROPYLENE

| | | | | | | | | |
|--------------|-----------------|---|-------|-------|-------|-------|-------|-------|
| 90/ I | silver anodised |  | 78236 | 78231 | 78190 | 78370 | 78195 | 78091 |
|--------------|-----------------|---|-------|-------|-------|-------|-------|-------|

euro/pc

no partial packaging

JUNCTION









pack 4 pcs H cm

| ART. | finishing | 4 | 5 | 6 | 7 | 8 | 10 |
|------|-----------|---|---|---|---|---|----|
|------|-----------|---|---|---|---|---|----|



METAL

| | | | | | | | | |
|--|--------|---|-------|-------|-------|-------|-------|-------|
| | silver |  | 78632 | 78642 | 78652 | 78662 | 78672 | 78682 |
|--|--------|---|-------|-------|-------|-------|-------|-------|

euro/pc

| | | | | | | | | |
|---------------|----------------------------|---|-------|---|-------|---|-------|---|
| | titanium |  | - | - | 78656 | - | - | - |
| | polished white RAL 9010 |  | - | - | 78666 | - | - | - |
| | matt white RAL 9010 |  | - | - | 78676 | - | - | - |
| 90/ MG | anthracite grey |  | - | - | 78686 | - | - | - |
| | ancient grey |  | - | - | 78696 | - | - | - |
| | polished titanium |  | - | - | 78699 | - | 78703 | - |
| | brushed silver |  | 78738 | - | 78740 | - | 78742 | - |
| | brushed gold |  | - | - | 78726 | - | 78746 | - |
| | brushed titanium |  | 78716 | - | 78736 | - | 78756 | - |

euro/pc

| | | | | | | | | |
|---------------|-------------|---|---|---|-------|---|---|---|
| 90/ MG | white stone |  | - | - | 78187 | - | - | - |
| | black stone |  | - | - | 78188 | - | - | - |

euro/pc

| | | | | | | | | |
|----------------|------------------------------------|---|---|---|-------|---|---|---|
| 90H/ MG | white RAL 9003 antibacterial |  | - | - | 78692 | - | - | - |
|----------------|------------------------------------|---|---|---|-------|---|---|---|

euro/pc

POLYPROPYLENE

| | | | | | | | | |
|--------------|-----------------|---|-------|-------|-------|-------|-------|-------|
| 90/ G | silver anodised |  | 78237 | 78232 | 78192 | 78372 | 78197 | 78092 |
|--------------|-----------------|---|-------|-------|-------|-------|-------|-------|

euro/pc

no partial packaging

OUTSIDE CORNER









pack 4 pcs H cm

| ART. | finishing | 4 | 5 | 6 | 7 | 8 | 10 |
|------|-----------|---|---|---|---|---|----|
|------|-----------|---|---|---|---|---|----|



METAL

| | | | | | | | | |
|--|--------|---|-------|-------|-------|-------|-------|-------|
| | silver |  | 78631 | 78641 | 78651 | 78661 | 78671 | 78681 |
|--|--------|---|-------|-------|-------|-------|-------|-------|

euro/pc

| | | | | | | | | |
|---------------|----------------------------|---|-------|---|-------|---|-------|---|
| | titanium |  | - | - | 78655 | - | - | - |
| | polished white RAL 9010 |  | - | - | 78665 | - | - | - |
| | matt white RAL 9010 |  | - | - | 78675 | - | - | - |
| 90/ ME | anthracite grey |  | - | - | 78685 | - | - | - |
| | ancient grey |  | - | - | 78695 | - | - | - |
| | polished titanium |  | - | - | 78698 | - | 78702 | - |
| | brushed silver |  | 78728 | - | 78730 | - | 78732 | - |
| | brushed gold |  | - | - | 78725 | - | 78745 | - |
| | brushed titanium |  | 78715 | - | 78735 | - | 78755 | - |

euro/pc

| | | | | | | | | |
|---------------|-------------|---|---|---|-------|---|---|---|
| 90/ ME | white stone |  | - | - | 78174 | - | - | - |
| | black stone |  | - | - | 78178 | - | - | - |

euro/pc

| | | | | | | | | |
|----------------|------------------------------------|---|---|---|-------|---|---|---|
| 90H/ ME | white RAL 9003 antibacterial |  | - | - | 78691 | - | - | - |
|----------------|------------------------------------|---|---|---|-------|---|---|---|

euro/pc

POLYPROPYLENE

| | | | | | | | | |
|--------------|-----------------|---|-------|-------|-------|-------|-------|-------|
| 90/ E | silver anodised |  | 78235 | 78230 | 78191 | 78371 | 78196 | 78090 |
|--------------|-----------------|---|-------|-------|-------|-------|-------|-------|

euro/pc

no partial packaging

RIGHT/LEFT END CAPS









4 couples pack H cm

| ART. | finishing | 4 | 5 | 6 | 7 | 8 | 10 |
|------|-----------|---|---|---|---|---|----|
|------|-----------|---|---|---|---|---|----|



METAL

| | | | | | | | | |
|--|--------|---|-------|-------|-------|-------|-------|-------|
| | silver |  | 78633 | 78643 | 78653 | 78663 | 78673 | 78683 |
|--|--------|---|-------|-------|-------|-------|-------|-------|

euro/couple

| | | | | | | | | |
|---------------|----------------------------|---|-------|---|-------|---|-------|---|
| | titanium |  | - | - | 78657 | - | - | - |
| | polished white RAL 9010 |  | - | - | 78667 | - | - | - |
| | matt white RAL 9010 |  | - | - | 78677 | - | - | - |
| 90/ MP | anthracite grey |  | - | - | 78687 | - | - | - |
| | ancient grey |  | - | - | 78697 | - | - | - |
| | polished titanium |  | - | - | 78701 | - | 78721 | - |
| | brushed silver |  | 78748 | - | 78750 | - | 78752 | - |
| | brushed gold |  | - | - | 78727 | - | 78747 | - |
| | brushed titanium |  | 78717 | - | 78737 | - | 78757 | - |

euro/couple

| | | | | | | | | |
|---------------|-------------|---|---|---|-------|---|---|---|
| 90/ MP | white stone |  | - | - | 78189 | - | - | - |
| | black stone |  | - | - | 78199 | - | - | - |

euro/couple

| | | | | | | | | |
|----------------|------------------------------------|---|---|---|-------|---|---|---|
| 90H/ MP | white RAL 9003 antibacterial |  | - | - | 78693 | - | - | - |
|----------------|------------------------------------|---|---|---|-------|---|---|---|

euro/couple

POLYPROPYLENE

| | | | | | | | | |
|--------------|-----------------|---|-------|-------|-------|-------|-------|-------|
| 90/ P | silver anodised |  | 78238 | 78233 | 78193 | 78373 | 78198 | 78093 |
|--------------|-----------------|---|-------|-------|-------|-------|-------|-------|

euro/couple

no partial packaging

skirting board metal line

Metal Line 790 is a skirting board in polished or brushed stainless steel, available in different heights, that follows the minimalist trends of modern design. Thanks to the curved section, this skirting board perfectly hides the perimetral expansion gap of a floating floor. Metal Line 790 can be easily and quickly installed through specific adhesives.



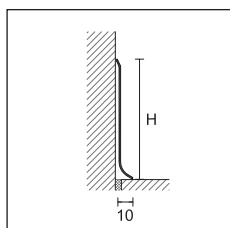

790/6 polished stainless steel AISI 304 DIN 1.4301



METAL LINE 790

length = 270 cm - pack 10 pcs

| | | H cm | | | | | |
|------------------------|---|---|-------|-------|-------|-------|-------|
| ART. | finishing | 4 | 5 | 6 | 8 | 10 | |
| STAINLESS STEEL | | | | | | | |
| 790/ SF | polished stainless steel AISI 304 DIN 1.4301 |  | 78120 | 78108 | 78129 | 78132 | 78139 |
| | brushed stainless steel AISI 304 DIN 1.4301 |  | 78128 | 78109 | 78126 | 78127 | 78140 |

euro/m

individually packed - art. 790/10 SF pack 5 pcs



790/MI
790/MIS



790/ME
790/MES

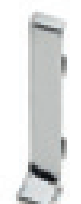



790/MG
790/MGS



790/MP
790/MPS

INSIDE CORNER IN METAL



pack 4 pcs

| | | H cm | | | | | |
|----------|--------------------|--|-------|-------|-------|-------|-------|
| ART. | finishing | 4 | 5 | 6 | 8 | 10 | |
| 790/ MI | finishing polished |  | 78760 | 78761 | 78762 | 78763 | 78764 |
| | <i>euro/pc</i> | | | | | | |
| 790/ MIS | finishing brushed |  | 78780 | 78781 | 78782 | 78783 | 78784 |
| | <i>euro/pc</i> | | | | | | |

no partial packaging

OUTSIDE CORNER IN METAL



pack 4 pcs

| | | H cm | | | | | |
|----------|--------------------|---|-------|-------|-------|-------|-------|
| ART. | finishing | 4 | 5 | 6 | 8 | 10 | |
| 790/ ME | finishing polished |  | 78765 | 78766 | 78767 | 78768 | 78769 |
| | <i>euro/pc</i> | | | | | | |
| 790/ MES | finishing brushed |  | 78785 | 78786 | 78787 | 78788 | 78789 |
| | <i>euro/pc</i> | | | | | | |

no partial packaging

JUNCTION IN METAL



pack 4 pcs

| | | H cm | | | | | |
|----------|--------------------|---|-------|-------|-------|-------|-------|
| ART. | finishing | 4 | 5 | 6 | 8 | 10 | |
| 790/ MG | finishing polished |  | 78770 | 78771 | 78772 | 78773 | 78774 |
| | <i>euro/pc</i> | | | | | | |
| 790/ MGS | finishing brushed |  | 78790 | 78791 | 78792 | 78793 | 78794 |
| | <i>euro/pc</i> | | | | | | |

no partial packaging

RIGHT/LEFT END CAPS IN METAL

4 couples pack

| | | H cm | | | | | |
|----------|--------------------|---|-------|-------|-------|-------|-------|
| ART. | finishing | 4 | 5 | 6 | 8 | 10 | |
| 790/ MP | finishing polished |  | 78775 | 78776 | 78777 | 78778 | 78779 |
| | <i>euro/couple</i> | | | | | | |
| 790/ MPS | finishing brushed |  | 78795 | 78796 | 78797 | 78798 | 78799 |
| | <i>euro/couple</i> | | | | | | |

no partial packaging

The self-adhesive version is available in every height on request, with a minimum order of 200 meters and a surcharge of

Complete the article code with H measure (for example 790/SF for H=4 becomes 790/4SF)

Metal Line 92 and 93 are two skirting boards in aluminium, characterized by a simple design and a slightly-rounded shape, that create a perfect junction between the floor and the wall. These two elements are easy to install thanks to the interlocking system with supports, in natural aluminium or PVC, to be fixed to the wall with screws and dowels.



92/7 silver anodised aluminium + S/95 aluminium support

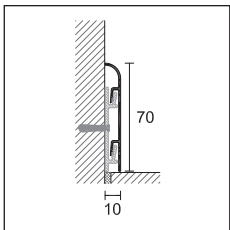

92/7



METAL LINE 92

length = 200 cm + 3 supports - pack 20 pcs

H cm

ART. finishing

7

ALUMINIUM

92/7 silver anodised
euro/m

78490

individually packed

ALUMINIUM SUPPORT

pack 100 pcs

S/95

78295

euro/pc

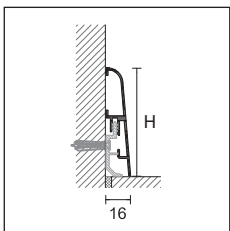

93/



METAL LINE 93

length = 200 cm + 5 supports - pack 20 pcs

H cm

ART. finishing

7

9

ALUMINIUM

93/ silver anodised
euro/m

78495

78496

individually packed

FIXING CLIPS

pack 100 pcs

8608/C

29751

euro/pack

Ancient grey, RAL 9003, RAL 7038, RAL 8019, RAL 9006, RAL 9007 colour-coated aluminium skirting boards are available on request, with a minimum order of 300 meters. For other colours, please contact our sales department.



93/7 silver anodised aluminium + 8608/C fixing clips

skirting board

metal line

Metal Line 89 is a skirting board in aluminium, in different finishes, characterized by square and minimalist lines; available in different heights, it outlines the space with simplicity and elegance. Fixed on the wall through specific adhesives, it perfectly hides the perimetral expansion gap of a floating floor, as well as having a decorative role. Metal Line 89 is also available in white and black Trend Color Stone, two matt colours that perfectly combines with the most modern ceramic coverings.

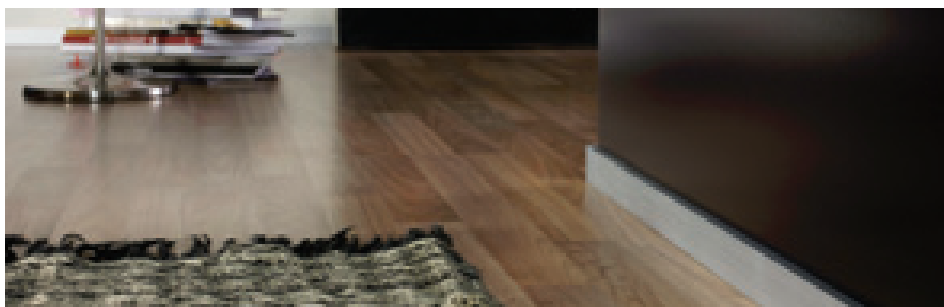

89/4 silver anodised aluminium

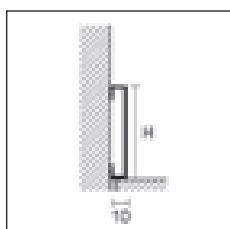

89/
89/ TM
89H/



89/ EI

TREND
COLOR



Metal Line 89 bright brushed titanium



89/4 ancient grey colour-coated aluminium + 89/4EI

METAL LINE 89

length = 200 cm - pack 25 pcs

| | | H cm | | |
|--|---|-------|-------|-------|
| ART. | finishing | 4 | 6 | 8 |
| ALUMINIUM | | | | |
| | silver anodised | 78378 | 78478 | 78487 |
| | <i>euro/m</i> | | | |
| | titanium anodised | 78521 | 78522 | - |
| | <i>euro/m</i> | | | |
| 89/ | colour-coated matt white RAL 9010 | 78517 | 78518 | - |
| | <i>euro/m</i> | | | |
| | colour-coated ancient grey | 78515 | 78485 | - |
| | colour-coated rust | 78516 | - | - |
| | <i>euro/m</i> | | | |
| 89/ TM | bright brushed titanium | 78388 | 78480 | - |
| | <i>euro/m</i> | | | |
| TREND COLOR STONE | | | | |
| 89/ | colour-coated white stone | 78481 | - | - |
| | colour-coated black stone | 78482 | - | - |
| | <i>euro/m</i> | | | |
| COLOUR-COATED ALUMINIUM ANTIBACTERIAL | | | | |
| 89H/ | colour-coated white RAL 9003 antibacterial | - | 78531 | - |
| | <i>euro/m</i> | | | |

individually packed

Ancient grey, RAL 9003, RAL 7038, RAL 8019, RAL 9006, RAL 9007 colour-coated aluminium skirting boards are available on request, with a minimum order of 300 meters. For other colours, please contact our sales department.

INSIDE/OUTSIDE CORNER - RIGHT/LEFT END CAP

| | | H cm | | |
|------------------|---|-------|-------|-------|
| ART. | finishing | 4 | 6 | 8 |
| pack 4 pcs | | | | |
| ALUMINIUM | | | | |
| | silver anodised | 78505 | 78506 | 78527 |
| | <i>euro/pc</i> | | | |
| | titanium anodised | 78523 | 78524 | - |
| | <i>euro/pc</i> | | | |
| 89/ EI | colour-coated matt white RAL 9010 | 78519 | 78520 | - |
| | <i>euro/pc</i> | | | |
| | colour-coated ancient grey | 78512 | 78513 | - |
| | colour-coated rust | 78514 | - | - |
| | <i>euro/pc</i> | | | |
| 89/ TMEI | bright brushed titanium | 78509 | 78510 | - |
| | <i>euro/pc</i> | | | |
| 89/ EI | colour-coated white stone | 78507 | - | - |
| | colour-coated black stone | 78508 | - | - |
| | <i>euro/pc</i> | | | |
| 89H/ EI | colour-coated white RAL 9003 antibacterial | - | 78533 | - |
| | <i>euro/pc</i> | | | |

no partial packaging

Complete the article code with H measure (for example 89/ for H=4 becomes 89/4).

In anodised aluminium, Metal Line 89 I Design is characterized by a special scratched finish and original colours that allow different chromatic combinations, created for interior designers and architects by following the latest trends of modern design.

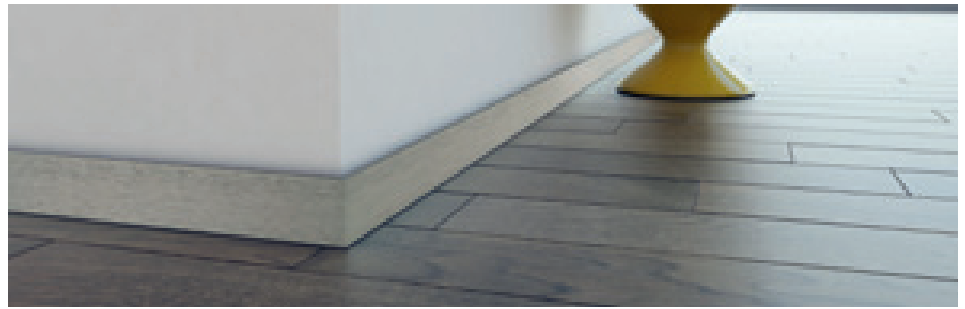

89/6 titanium anodised aluminium

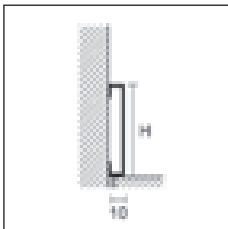

89/



METAL LINE - I DESIGN

length = 200 cm - pack 25 pcs

| | | H | |
|---------------------------|------------|---|-------------|
| ART. | finishing | 4 | 6 |
| ANODISED ALUMINIUM | | | |
| 89/ | platinum | | 31400 31402 |
| | titanium | | 31410 31412 |
| | brown | | 31420 31422 |
| | dark brown | | 31430 31432 |
| | carbon | | 31440 31442 |
| euro/m | | | |

individually packed

INSIDE/OUTSIDE CORNER - RIGHT/LEFT END CAP

pack 2 pcs

| | | H | |
|---------------------------|------------|---|-------------|
| ART. | finishing | 4 | 6 |
| ANODISED ALUMINIUM | | | |
| 89/ EI | platinum | | 31450 31452 |
| | titanium | | 31460 31462 |
| | brown | | 31470 31472 |
| | dark brown | | 31480 31482 |
| | carbon | | 31490 31492 |
| euro/pc | | | |

no partial packaging

Complete the article code with H measure (for example 89/ for H=4 becomes 89/4)

Metal Line 89 is a skirting board in anodised aluminium with LED-strip lighting system. The light is distributed along the entire length of the profile through a diffuser element. It is possible to insert the dimmer in order to adjust the luminous intensity of the skirting board to decorate and light up the room.

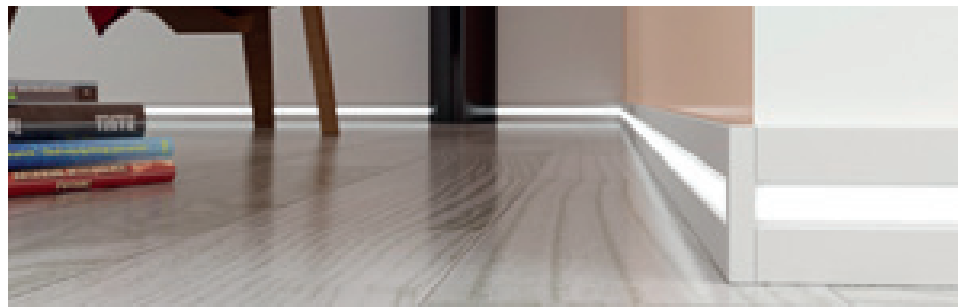

89/6L silver anodised aluminium

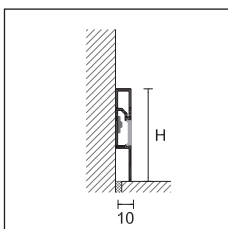

89/6L



PROLIGHT METAL LINE 89

length = 200 cm - pack 25 pcs

| | | H cm | |
|------------------|-----------------|------|-------|
| ART. | finishing | 6 | |
| ALUMINIUM | | | |
| 89/6L | silver anodised | | 86000 |
| euro/m | | | |

individually packed

INSIDE/OUTSIDE CORNER - RIGHT/LEFT END CAP

pack 4 pcs

| | | H cm | |
|------------------|-----------------|------|-------|
| ART. | finishing | 6 | |
| ALUMINIUM | | | |
| 89/6EI | silver anodised | | 78506 |
| euro/pc | | | |

no partial packaging



89/6EI

For the best aesthetic result and the validity of the warranty, we suggest the exclusive use of our electrical components. See page 236

skirting board

metal line

Metal Line 89/613 is a skirting board in aluminium characterized by square and minimalist lines. With a thickness of 13 mm, it perfectly hides the perimetral expansion gap of a floating floor.



89/613 silver anodised aluminium

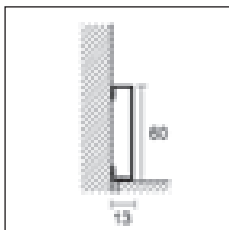

89/613



METAL LINE 89/613

length = 200 cm - pack 25 pcs

H cm

ART. finishing

6

ALUMINIUM

| | | |
|---|---|-------|
| silver anodised |  | 78486 |
| euro/m | | |
| 89/613 colour-coated matt white RAL 9010 | <input type="checkbox"/> | 78488 |
| euro/m | | |

individually packed

INSIDE/OUTSIDE CORNER - RIGHT/LEFT END CAP

pack 4 pcs

H cm

ART. finishing

6

ALUMINIUM

| | | |
|--|---|-------|
| silver anodised |  | 78525 |
| euro/pc | | |
| 89/613E colour-coated matt white RAL 9010 | <input type="checkbox"/> | 78526 |
| euro/pc | | |

no partial packaging

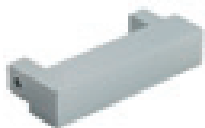

89/613 EI

Metal Line 105 is a skirting board in aluminium, characterized by square and minimalist lines. This model stands out for a simple and quick interlocking installation system with a coextruded PVC base to be fixed to the wall through screws and dowels.



Metal Line 105 silver anodised aluminium

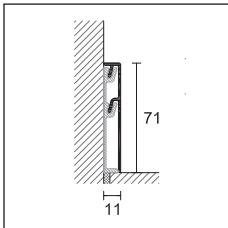

105/7
105/CB



METAL LINE

pack 10 pcs **H cm**

ART. finishing length 7

ALUMINIUM

| | | | | |
|-------|-----------------|--|--------|-------|
| 105/7 | silver anodised | | 200 cm | 78900 |
| | silver anodised | | 400 cm | 78910 |

euro/m

individually packed

FIXING BASE

pack 10 pcs **H cm**

ART. length 7

CO-EXTRUDED PVC

| | | | | |
|--------|-------|--|--------|-------|
| 105/CB | white | | 200 cm | 78920 |
|--------|-------|--|--------|-------|

euro/m

no partial packaging

INSIDE CORNER

pack 4 pcs **H cm**

ART. finishing 7

METAL

| | | | | |
|--------|--------|--|--|-------|
| 105/7I | silver | | | 78932 |
|--------|--------|--|--|-------|

euro/pc

no partial packaging

OUTSIDE CORNER

pack 4 pcs **H cm**

ART. finishing 7

METAL

| | | | | |
|--------|--------|--|--|-------|
| 105/7E | silver | | | 78934 |
|--------|--------|--|--|-------|

euro/pc

no partial packaging

JUNCTION

pack 4 pcs **H cm**

ART. finishing 7

METAL

| | | | | |
|--------|--------|--|--|-------|
| 105/7G | silver | | | 78936 |
|--------|--------|--|--|-------|

euro/pc

no partial packaging

RIGHT/LEFT END CAP

4 couples pack **H cm**

ART. finishing 7

METAL

| | | | | |
|--------|--------|--|--|-------|
| 105/7P | silver | | | 78938 |
|--------|--------|--|--|-------|

euro/couple

no partial packaging

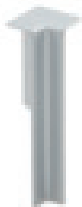

105/7I



105/7E



105/7G



105/7P

metal line

Metal Line 87/6 and 88/6 are two flush recessed skirting boards for plaster and plasterboards. Both are composed of two separate elements: a base in natural aluminium and an insert in silver anodised or matt white colour-coated aluminium. Once installed, the skirting board integrates perfectly into the wall surface, outlining the perimeter of the space without limiting it. There are two different phases of installation: the base element must be installed when the room is still in its rough state, while the chosen insert must be put after the laying of the floor.



87/6 e 88/6 natural aluminium + 88/16L/A aluminium insert for LED light

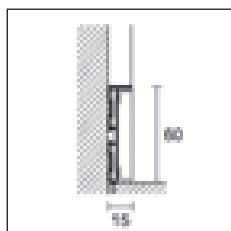

87/6 + 88/16SF
aluminium insert

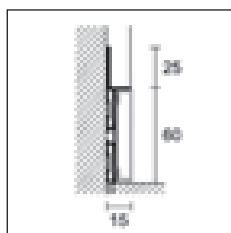

88/6 + 88/16SF
aluminium insert

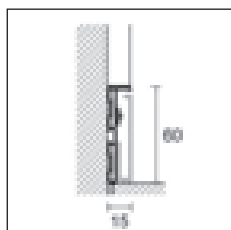

87/6 + 88/16L/A
aluminium insert for
LED light

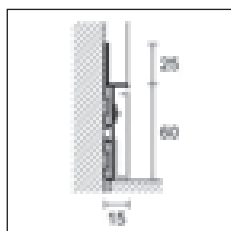

88/6 + 88/16L/A
aluminium insert for
LED light



88/6E

For the best aesthetic result and the validity of the warranty, we suggest the exclusive use of our electrical components. See page 236

METAL LINE 87 E 88

length = 200 cm - pack 20 pcs

H cm

ART. finishing

6

ALUMINIUM

87/6 natural aluminium (drilled)

78338

euro/m

88/6 natural aluminium (drilled)

78310

euro/m

individually packed

ALUMINIUM INSERT

length = 200 cm - pack 20 pcs

H cm

ART. finishing

6

88/16SF silver anodised

78563

88/16SF matt white RAL 9010
colour-coated

78558

euro/m

individually packed

ALUMINIUM INSERT FOR LED LIGHT

length = 200 cm - pack 20 pcs

H cm

88/16L/A silver anodised

78559

88/16L/A matt white RAL 9010
colour-coated

78560

euro/m

adhesive - individually packed
for electrical components, see page 236

METAL OUTSIDE CORNER

pack 4 pcs

H cm

ART. finishing

6

88/6E silver

78561

88/6E matt white RAL 9010
colour-coated

78562

euro/pc

no partial packaging



88/6 natural aluminium + 88/16SF matt white aluminium insert

Prolight Metal Line SKL/2 is a skirting board in aluminium with indirect LED light. Its special section allows to create an original play of light along the wall, thus adding value to the whole surface. In addition to the silver anodised and the white stone versions, SKL/2 is available in a wide range of colours including five original cement effects, two special metal tonalities and a white characterized by an extremely solid and full colour.



SKL/2 concrete white colour-coated aluminium

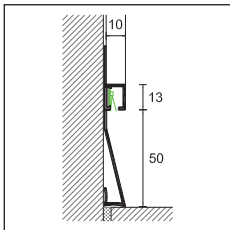

SKL/2



TREND
COLOR

PROLIGHT METAL LINE S

length = 270 cm - pack 5 pcs

H

ART. finishing

10

ALUMINIUM

SKL/2 silver anodised
euro/m

78579

COLOUR-COATED ALUMINIUM

| | | |
|-------|-------------------|-------|
| SKL/2 | white stone | 78591 |
| | concrete white | 78592 |
| | concrete graphite | 78593 |
| | concrete smoke | 78594 |
| | concrete mud | 78595 |
| | concrete sand | 78596 |
| | metal dark | 78597 |
| | metal light | 78598 |
| | solid white | 78599 |
| | euro/m | |

individually packed

ELECTRICAL COMPONENTS AND ACCESSORIES FOR LIGHTING

| ART. | description | |
|------------|--|-------|
| L5/NW/65 L | spool 5 m LED strips, lateral light, neutral colour 4000 °K, 9,6W/m IP65 | 84136 |
| | euro/mt (euro/pack) | |

For other electrical components see page 236

Metal Line AF M Design is a skirting board in aluminium characterized by modern and minimalist lines that mark the connection between floors and coverings of same or different materials. The empty space creates an elegant shadow that highlights the two surfaces distinctly.



AF/1/ silver anodised aluminium

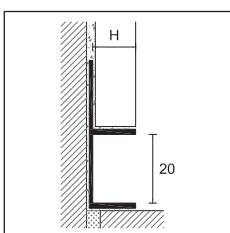

AF/1/



METAL LINE AF - M DESIGN

length = 270 cm - pack 10 pcs

H

ART. finishing

6

10

12,5

ALUMINIUM

| | | | | |
|-------|---------------------------------------|-------|-------|-------|
| | silver anodised | 13198 | 13199 | 13200 |
| | euro/m | | | |
| AF/1/ | titanium anodised | 13201 | 13203 | 13202 |
| | colour-coated polished white RAL 9010 | 13196 | 13197 | 13204 |
| | euro/m | | | |

individually packed

metal line

Metal Line 100 is an anodized aluminium baseboard available in two heights and suitable for application of plasterboard, directly into the wall. The profile is easy to apply through the use of appropriate adhesives.

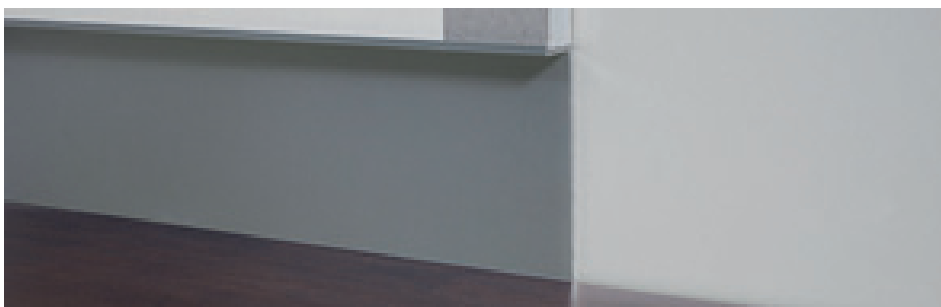

100/70 silver anodised aluminium

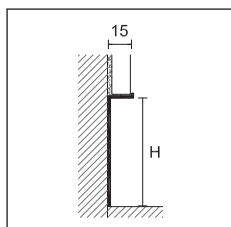

100/



METAL LINE 100

length = 200 cm - pack 20 pcs

H mm

| ART. | finishing | | 40 | 70 |
|------|-----------|--|----|----|
|------|-----------|--|----|----|

ALUMINIUM

| | | | | |
|------|-----------------|--|-------|-------|
| 100/ | silver anodised | | 78277 | 78279 |
|------|-----------------|--|-------|-------|

individually packed

Metal Line 101, ideal for plaster and made of anodized aluminium, is suitable for application directly on the rough wall. The profile is applied using special adhesives, before making the plastering of the wall.



101/74 silver anodised aluminium

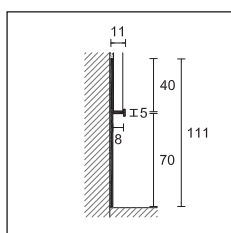

101/74



METAL LINE 101

length = 200 cm - pack 20 pcs

H mm

| ART. | finishing | | 70 |
|------|-----------|--|----|
|------|-----------|--|----|

ALUMINIUM

| | | | |
|--------|-----------------|--|-------|
| 101/74 | silver anodised | | 78281 |
|--------|-----------------|--|-------|

individually packed

ADHESIVE

Cartridges 12 pcs - 300 ml (MS 45) and 290 ml (MS 55)

ART.

| | | | |
|----------------|-------|--------------------------|-----------|
| MAPEFLEX MS 45 | white | <input type="checkbox"/> | 6PB010043 |
|----------------|-------|--------------------------|-----------|

| | | | |
|----------------|-------|--------------------------|-----------|
| MAPEFLEX MS 55 | white | <input type="checkbox"/> | 6PV010043 |
|----------------|-------|--------------------------|-----------|

For further information, please see Mapei price list.

Ancient grey, RAL 9003, RAL 7038, RAL 8019, RAL 9006, RAL 9007 colour-coated aluminium skirting boards are available on request, with a minimum order of 300 meters.

For other colours, please contact our sales department.

Metal Line 95 is a skirting board in aluminium, available in two different heights, that allows to hide service cables (telephone, computers, TV etc.). This model is characterized by a simple and quick interlocking installation system with natural aluminium supports that, fixed to the wall with screws and dowels, facilitate the removal for the maintenance of the service cables.

Metal Line 94/7SF is a skirting board with a section that facilitates fixing to the wall with cement-based adhesives.

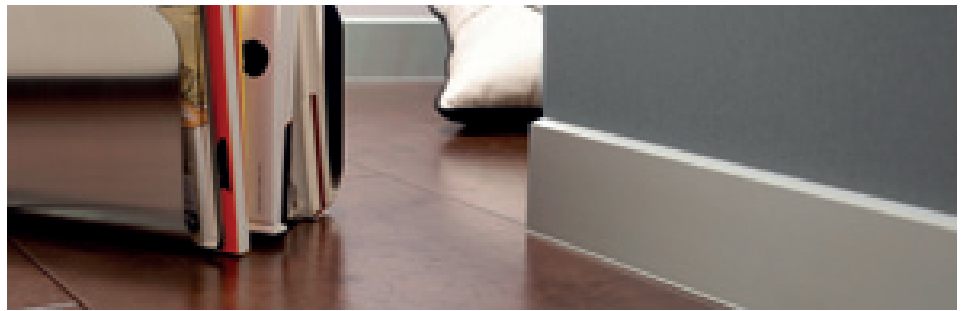

95/7SF silver anodised aluminium

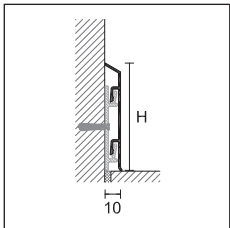

95/



METAL LINE 95

| pack 25 pcs | | length | H cm | |
|------------------|------------------|---------------------|----------|-----------|
| ART. | finishing | | 7 | 10 |
| ALUMINIUM | | | | |
| 95/ SF | silver anodised | 200 cm + 3 supports | 78160 | 78175 |
| | | 400 cm + 6 supports | 78161 | 78176 |
| euro/m | | | | |

individually packed - length 400 cm pack 10 pcs

ALUMINIUM SUPPORT

| pack 100 pcs | | | | |
|----------------------|--|--|-------|--|
| S/95 | | | 78295 | |
| euro/pc | | | | |
| no partial packaging | | | | |

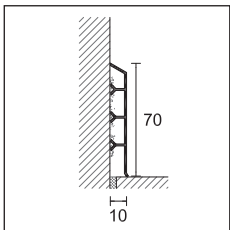

94/7SF

NEW

METAL LINE 94

| length = 200 cm - pack 25 pcs | | | | |
|-------------------------------|------------------|--|-------|--|
| ART. | finishing | | | |
| ALUMINIUM | | | | |
| 94/7SF | silver anodised | | 78354 | |
| euro/m | | | | |
| individually packed | | | | |



95/7I inside corner

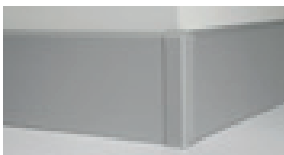

95/7E outside corner



95/7G junction

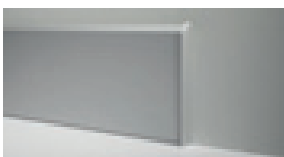

95/7P right end cap

INSIDE CORNER IN POLYPROPYLENE

| pack 4 pcs | | H cm | | |
|----------------------|------------------|----------|-----------|--|
| ART. | finishing | 7 | 10 | |
| 95/ I | silver anodised | 78201 | 78206 | |
| euro/pc | | | | |
| no partial packaging | | | | |

OUTSIDE CORNER IN POLYPROPYLENE

| pack 4 pcs | | H cm | | |
|----------------------|------------------|----------|-----------|--|
| ART. | finishing | 7 | 10 | |
| 95/ E | silver anodised | 78200 | 78205 | |
| euro/pc | | | | |
| no partial packaging | | | | |

JUNCTION IN POLYPROPYLENE

| pack 4 pcs | | H cm | | |
|----------------------|------------------|----------|-----------|--|
| ART. | finishing | 7 | 10 | |
| 95/ G | silver anodised | 78202 | 78207 | |
| euro/pc | | | | |
| no partial packaging | | | | |

RIGHT/LEFT END CAPS IN POLYPROPYLENE

| 4 couples pack | | H cm | | |
|----------------------|------------------|----------|-----------|--|
| ART. | finishing | 7 | 10 | |
| 95/ P | silver anodised | 78203 | 78208 | |
| euro/couple | | | | |
| no partial packaging | | | | |

Ancient grey, RAL 9003, RAL 7038, RAL 8019, RAL 9006, RAL 9007 colour-coated aluminium skirting boards are available on request, with a minimum order of 300 meters. For other colours, please contact our sales department.

Complete the article code with H measure (for example 95/SF for H=7 becomes 95/7SF)

metal line

Metal Line 98 is a skirting board in aluminium characterized by round and soft lines and a thickness that allows the housing of service cables (telephone, computer, TV, etc.). A simple and functional interlocking installation system with natural aluminium supports to be fixed to the wall provides easy access to the cables for their maintenance.



98/7SF silver anodised aluminium

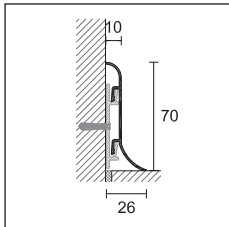

98/7SF



METAL LINE 98

pack 20 pcs

H cm

| ART. | finishing | length | 7 |
|------|-----------|--------|---|
|------|-----------|--------|---|

ALUMINIUM

| | | | |
|--------|-----------------|---------------------|-------|
| 98/7SF | silver anodised | 200 cm + 3 supports | 78040 |
| | | 400 cm + 6 supports | 78041 |

euro/m

individually packed - length 400 cm pack 10 pcs

ALUMINIUM SUPPORT

pack 100 pcs

| | |
|------|-------|
| S/95 | 78295 |
|------|-------|

euro/pc

no partial packaging

INSIDE CORNER IN POLYPROPYLENE

pack 4 pcs

H cm

| ART. | finishing | 7 |
|------|-----------|---|
|------|-----------|---|

| | | |
|-------|-----------------|-------|
| 98/7I | silver anodised | 78221 |
|-------|-----------------|-------|

euro/pc

no partial packaging

OUTSIDE CORNER IN POLYPROPYLENE

pack 4 pcs

H cm

| ART. | finishing | 7 |
|------|-----------|---|
|------|-----------|---|

| | | |
|-------|-----------------|-------|
| 98/7E | silver anodised | 78220 |
|-------|-----------------|-------|

euro/pc

no partial packaging

JUNCTION IN POLYPROPYLENE

pack 4 pcs

H cm

| ART. | finishing | 7 |
|------|-----------|---|
|------|-----------|---|

| | | |
|-------|-----------------|-------|
| 98/7G | silver anodised | 78222 |
|-------|-----------------|-------|

euro/pc

no partial packaging

RIGHT/LEFT END CAPS IN POLYPROPYLENE

4 couples pack

H cm

| ART. | finishing | 7 |
|------|-----------|---|
|------|-----------|---|

| | | |
|-------|-----------------|-------|
| 98/7P | silver anodised | 78223 |
|-------|-----------------|-------|

euro/couple

no partial packaging



98/7SF silver anodised aluminium + S/95 aluminium support

Ancient grey, RAL 9003, RAL 7038, RAL 8019, RAL 9006, RAL 9007 colour-coated aluminium skirting boards are available on request, with a minimum order of 300 meters. For other colours, please contact our sales department.

Metal Line 97/4 is a 4 cm high aluminium skirting board that allows the housing of service cables (telephone, computer, TV, etc.). Thanks to a simple interlocking installation system with harmonic steel clips to be fixed to the wall with screws and dowels, it combines ease and speed of installation with easy access to the cables for their maintenance.

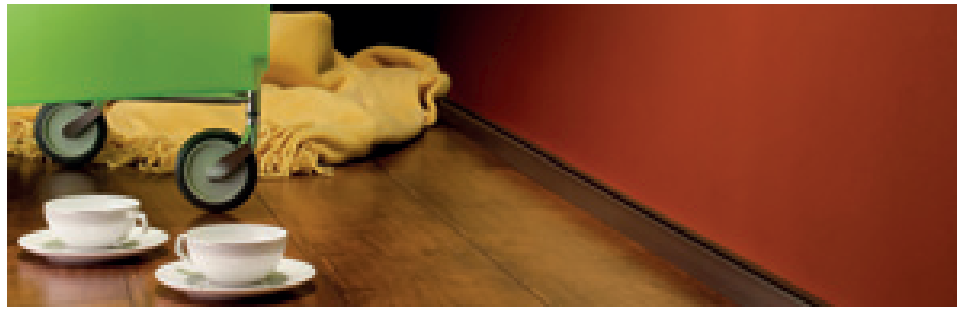

97/4SF

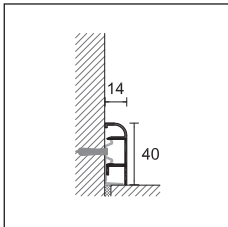

97/



METAL LINE 97

length = 200 cm - pack 25 pcs

H cm

ART. finishing

4

ALUMINIUM

97/4SF silver anodised



78000

+ 5 clips
euro/m

individually packed

FIXING CLIPS

10 blister packs / 20 pcs/blister

8602/C

29750

euro/blister

no partial packaging

INSIDE CORNER IN POLYPROPYLENE

pack 4 pcs

H cm

ART. finishing

4

97/4I silver anodised



78002

euro/pc

no partial packaging

OUTSIDE CORNER IN POLYPROPYLENE

pack 4 pcs

H cm

ART. finishing

4

97/4E silver anodised



78001

euro/pc

no partial packaging

JUNCTION IN POLYPROPYLENE

pack 4 pcs

H cm

ART. finishing

4

97/4G silver anodised



78003

euro/pc

no partial packaging

RIGHT/LEFT END CAPS IN POLYPROPYLENE

4 couples pack

H cm

ART. finishing

4

97/4P silver anodised



78004

euro/couple

no partial packaging



97/4SF silver anodised aluminium + 8602/C fixing clip

Ancient grey, RAL 9003, RAL 7038, RAL 8019, RAL 9006, RAL 9007 colour-coated aluminium skirting boards are available on request, with a minimum order of 300 meters. For other colours, please contact our sales department.

skirting board

metal line

Metal Line 97/7 is a 7 cm high aluminium skirting board with a simple and linear design. Easy and quick to install thanks to an interlocking installation system with natural aluminium supports to be fixed to the wall with screws and dowels, it provides easy access to the cables for their maintenance.

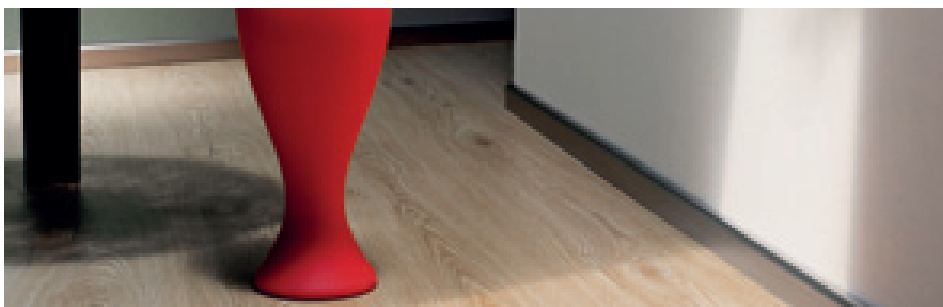

97/7SF silver anodised aluminium

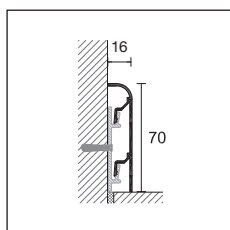

97/7SF



METAL LINE 97

length = 200 cm - pack 20 pcs

H cm

ART. finishing

7

ALUMINIUM

97/7SF +
3 supports

silver anodised



78005

euro/m

individually packed

ALUMINIUM SUPPORT

pack 100 pcs

S/95

78295

euro/pc

no partial packaging

INSIDE CORNER IN POLYPROPYLENE

pack 4 pcs

H cm

ART. finishing

7

97/7I silver anodised



78157

euro/pc

no partial packaging

OUTSIDE CORNER IN POLYPROPYLENE

pack 4 pcs

H cm

ART. finishing

7

97/7E silver anodised



78156

euro/pc

no partial packaging

JUNCTION IN POLYPROPYLENE

pack 4 pcs

H cm

ART. finishing

7

97/7G silver anodised



78158

euro/pc

no partial packaging

RIGHT/LEFT END CAPS IN POLYPROPYLENE

4 couples pack

H cm

ART. finishing

7

97/7P silver anodised



78159

euro/couple

no partial packaging

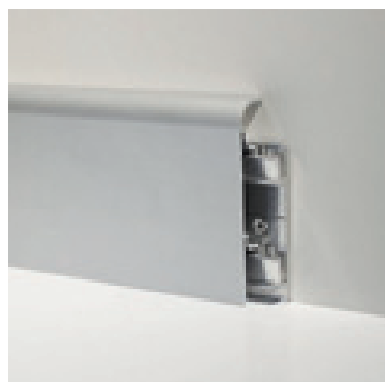

97/7SF silver anodised aluminium
+ S/95 aluminium support

Ancient grey, RAL 9003, RAL 7038, RAL 8019, RAL 9006, RAL 9007 colour-coated aluminium skirting boards are available on request, with a minimum order of 300 meters.

For other colours, please contact our sales department.

Metal Line 97/8 is a 8 cm high aluminium skirting board specially designed for housing cables thanks to the specific PVC cable trunking that, fixed to the wall with screws and dowels, also acts as support of the skirting board. It is particularly suitable for renovations as it avoids making new tracks for the passage of cables. It is also easy and quick to install only using natural aluminium supports that, fixed to the wall with screws and dowels, make the access to service cables easy.

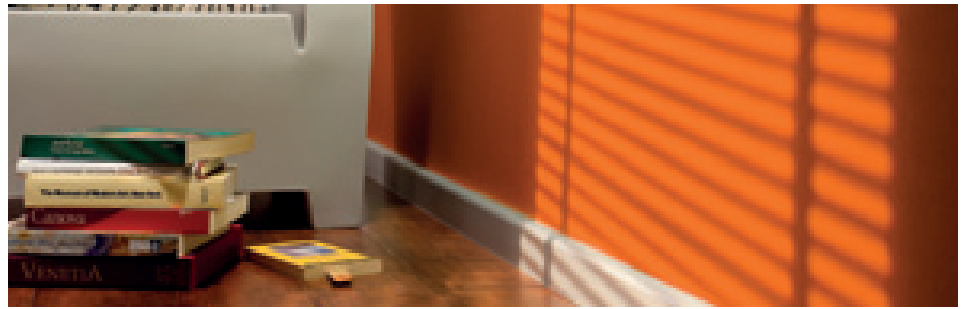

97/8SF silver anodised aluminium

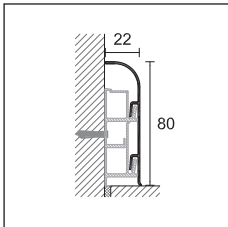

97/8SF



METAL LINE 97

| pack 20 pcs | | | H cm |
|------------------|-----------------|---------------------|-------|
| ART. | finishing | length | 8 |
| ALUMINIUM | | | |
| 97/8SF | silver anodised | 200 cm + 3 supports | 78010 |
| | | 400 cm + 6 supports | 78011 |
| <i>euro/m</i> | | | |

individually packed - length 400 cm pack 10 pcs

WHITE PVC TRUNKING

| length 200 cm - pack 20 pcs | | |
|-----------------------------|--------------------------|-------|
| 97/8CB | <input type="checkbox"/> | 78290 |
| <i>euro/m</i> | | |

no partial packaging

ALUMINIUM SUPPORT

| pack 100 pcs | | |
|----------------|--|-------|
| S/97 | | 78299 |
| <i>euro/pc</i> | | |

no partial packaging

INSIDE CORNER IN POLYPROPYLENE

| pack 4 pcs | | | H cm |
|----------------|-----------------|--|-------|
| ART. | finishing | | 8 |
| 97/8I | silver anodised | | 78211 |
| <i>euro/pc</i> | | | |

no partial packaging

OUTSIDE CORNER IN POLYPROPYLENE

| pack 4 pcs | | | H cm |
|----------------|-----------------|--|-------|
| ART. | finishing | | 8 |
| 97/8E | silver anodised | | 78210 |
| <i>euro/pc</i> | | | |

no partial packaging

JUNCTION IN POLYPROPYLENE

| pack 4 pcs | | | H cm |
|----------------|-----------------|--|-------|
| ART. | finishing | | 8 |
| 97/8G | silver anodised | | 78212 |
| <i>euro/pc</i> | | | |

no partial packaging

RIGHT/LEFT END CAPS IN POLYPROPYLENE

| 4 couples pack | | | H cm |
|--------------------|-----------------|--|-------|
| ART. | finishing | | 8 |
| 97/8P | silver anodised | | 78213 |
| <i>euro/couple</i> | | | |

no partial packaging



97/8SF silver anodised aluminium + 97/8CB white pvc trunking

Ancient grey, RAL 9003, RAL 7038, RAL 8019, RAL 9006, RAL 9007 colour-coated aluminium skirting boards are available on request, with a minimum order of 300 meters. For other colours, please contact our sales department.





PVC line skirting board

A range of PVC skirting boards to meet all technical and aesthetical needs. Suitable for both professional and DIY use, some models can be customised using digital printing technology PDS.

skirting board

pvc line

PVC Line 8605 and 8606 are two skirting boards in co-extruded PVC, characterized by a rounded shape and a 70-mm height. Both are composed of a core in foam PVC and a visible surface in coloured rigid PVC to guarantee the best aesthetic result and colour uniformity. 8605 can also be covered with Alcom® Plus film and can be further customized thanks to the digital printing technology Profilpas Digital System. 8505 and 8606 can be fixed to the wall with adhesive (like MS 45 or MS 55) or nails. Moreover, they do not absorb water and are resistant to impact, wear and tear, UV rays and the products normally used for cleaning floors and wall coverings.



8606 white RAL 9003 co-extruded PVC

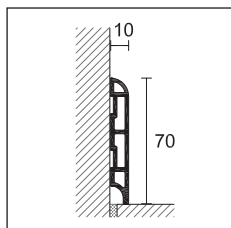

8605

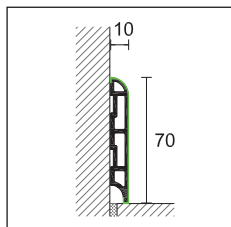

8605 covered with Alcom® Plus film



8605 foam PVC covered with Alcom® Plus film

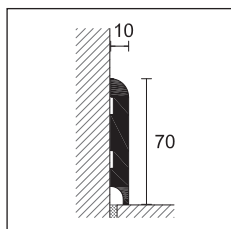

8606

Adhesive for skirting boards see page 249

For customizations with decors that are not in our database, there is an extra of € for decor.

PVC LINE

length 250 cm - pack 20 pcs - H = 70 mm

CO-EXTRUDED PVC (FOAM PVC + RIGID PVC)

ART.

| | | | |
|------|--------------------------|----------------|-------|
| 8605 | <input type="checkbox"/> | white RAL 9003 | 29175 |
| | <input type="checkbox"/> | white RAL 9010 | 29177 |

euro/m

no partial packaging

PVC LINE

length 250 cm - pack 20 pcs - H = 70 mm

CO-EXTRUDED PVC (FOAM PVC + RIGID PVC) COVERED WITH ALCROM® PLUS FILM

ART. decors

| | | | |
|------|-------------------------------------|----------------------------|-------|
| 8605 | <input type="checkbox"/> | 96 white RAL 9010 embossed | 29030 |
| | <input checked="" type="checkbox"/> | 97 black RAL 9005 embossed | 29031 |

euro/m

| | | | |
|------|--------------------------|-------------------|-------|
| 8605 | <input type="checkbox"/> | 99 brushed silver | 29035 |
| | <input type="checkbox"/> | 100 brushed steel | 29036 |

euro/m

no partial packaging

PVC LINE

length = 250 cm - pack 20 pcs - H = 70 mm

CO-EXTRUDED PVC (FOAM PVC + RIGID PVC) COVERED WITH ALCROM® PLUS FILM

| ART. | decors | | decors | | decors | | decors | |
|------|--------|-------|--------|-------|--------|-------|--------|-------|
| 8605 | 02 | 29000 | 44 | 29013 | 1009 | 29103 | 1063 | 29121 |
| | 08 | 29001 | 47 | 29033 | 1012 | 29104 | 1066 | 29122 |
| | 10 | 29003 | 48 | 29015 | 1021 | 29107 | 1069 | 29123 |
| | 11 | 29004 | 65 | 29018 | 1024 | 29108 | 1081 | 29127 |
| | 12 | 29005 | 76 | 29020 | 1030 | 29110 | 1084 | 29128 |
| | 20 | 29006 | 77 | 29021 | 1033 | 29111 | 1087 | 29129 |
| | 25 | 29032 | 78 | 29022 | 1036 | 29112 | 1090 | 29130 |
| | 32 | 29007 | 80 | 29023 | 1042 | 29114 | 1105 | 29135 |
| | 34 | 29008 | 81 | 29024 | 1045 | 29115 | 1108 | 29136 |
| | 35 | 29009 | 92 | 29026 | 1051 | 29117 | 1111 | 29137 |
| | 36 | 29010 | 95 | 29029 | 1054 | 29118 | | |
| | 40 | 29011 | 1003 | 29101 | 1057 | 29119 | | |
| | 41 | 29012 | 1006 | 29102 | 1060 | 29120 | | |

euro/m

no partial packaging - 8605 can be covered with customised Alcom® Plus film on request, with a minimum order of 500 meters €/m

PVC LINE

length 250 cm - pack 20 pcs - H = 70 mm

CO-EXTRUDED PVC (FOAM PVC + RIGID PVC)

ART.

| | | | |
|------|--------------------------|----------------|-------|
| 8606 | <input type="checkbox"/> | white RAL 9003 | 29227 |
| | <input type="checkbox"/> | white RAL 9010 | 29229 |

euro/m

no partial packaging - 8606 can be covered with customised Alcom® Plus film on request, with a minimum order of 500 meters €/m

PVC Line 8608 is a skirting board in PVC foam, characterized by a round shape and covered with Alcrom® Plus film. Available in several decors, it can be further customized thanks to the digital printing technology Profilpas Digital System. 8608 can be fixed to the wall with adhesive (like MS 45 or MS 55), nails or special fixing clips. PVC does not absorb water, does not contain formaldehyde, is resistant to shocks, wear (certificate AC3), UV rays and the most common cleaning products for floors and wall coverings.

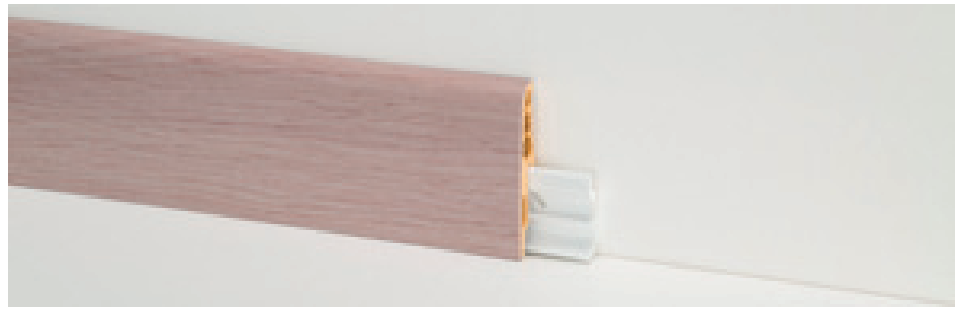

8608 foam PVC covered with Alcrom® Plus film + 8608/C

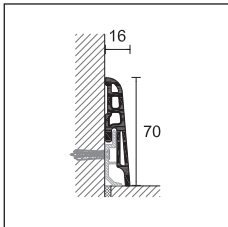

8608



PVC LINE

length = 250 cm - pack 20 pcs

FOAM PVC COVERED WITH ALCROM® PLUS FILM

H = 70 mm

| ART. | decors | | decors | | decors | |
|---------------|--------|-------------------|--------|----------|--------|----------------------------------|
| | | 02 29040 | | 32 29047 | | 77 29061 |
| | | 05 29075 | | 34 29048 | | 78 29062 |
| | | 08 29041 | | 35 29049 | | 80 29063 |
| | | 10 29043 | | 36 29050 | | 81 29064 |
| | | 11 29044 | | 39 29080 | | 89 29081 |
| 8608 | | 12 29045 | | 40 29051 | | 91 29082 |
| | | 14 29076 | | 41 29052 | | 92 29066 |
| | | 19 29077 | | 44 29053 | | 95 29069 |
| | | 20 29046 | | 47 29073 | | 96 white RAL 9010 embossed 29070 |
| | | 26 29078 | | 65 29058 | | 97 black RAL 9005 embossed 29071 |
| | | 31 29079 | | 76 29060 | | |
| euro/m | | | | | | |
| 8608 | | 99 brushed silver | 29083 | | | |
| | | 100 brushed steel | 29084 | | | |

euro/m

no partial packaging

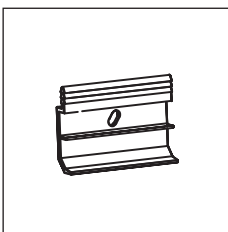

8608/C

FIXING CLIPS FOR ART. 8608

pack of 100 pcs

8608/C

29751

euro/pack



8608 foam PVC covered with Alcrom® Plus film Plus 99 brushed silver

Adhesive for skirting boards see page 249

Customized PDS decors on request for 8608 with a minimum order of 500 meters.

For customizations with decors that are not in our database, there is an extra of € for decor.

skirting board

pvc line

PVC Line 8615 and 8616 are two skirting boards in co-extruded PVC, characterized by a square shape and a 70-mm height. Both are composed of a core in foam PVC and a visible surface in coloured rigid PVC to guarantee the best aesthetic result and colour uniformity. They can also be covered with Alcrom® Plus film and can be further customized thanks to the digital printing technology Profilpas Digital System. 8615 and 8616 can be fixed to the wall with adhesive (like MS 45 or MS 55) or nails. Moreover, they do not absorb water and are resistant to impact, wear and tear, UV rays and the products normally used for cleaning floors and wall coverings.



8615 silver co-extruded PVC

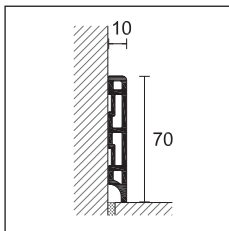

8615

PVC LINE

length 250 cm - pack 20 pcs - H = 70 mm

CO-EXTRUDED PVC (FOAM PVC + RIGID PVC)

ART.

| | | | |
|------|--------------------------|----------------|-------|
| 8615 | <input type="checkbox"/> | white RAL 9003 | 29353 |
| | <input type="checkbox"/> | white RAL 9010 | 29355 |

euro/m

no partial packaging

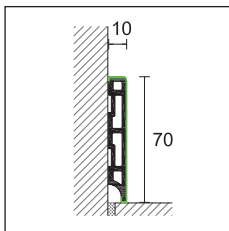

8615 decors with film Alcrom® Plus

PVC LINE

length 250 cm - pack 20 pcs - H = 70 mm

CO-EXTRUDED PVC (FOAM PVC + RIGID PVC) COVERED WITH ALCROM® PLUS FILM

ART. decors

| | | | |
|------|-------------------------------------|----------------------------|-------|
| 8615 | <input type="checkbox"/> | 96 white RAL 9010 embossed | 29357 |
| | <input checked="" type="checkbox"/> | 97 black RAL 9005 embossed | 29358 |

euro/m

no partial packaging

8615 can be covered with customised Alcrom® Plus film on request, with a minimum order of 500 meters €/m

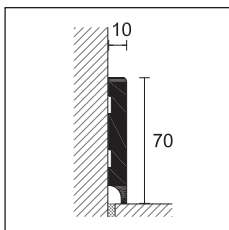

8616

PVC LINE

length 250 cm - pack 20 pcs - H = 70 mm

CO-EXTRUDED PVC (FOAM PVC + RIGID PVC)

ART.

| | | | |
|------|--------------------------|----------------|-------|
| 8616 | <input type="checkbox"/> | white RAL 9003 | 29495 |
|------|--------------------------|----------------|-------|

euro/m

no partial packaging

8616 can be covered with customised Alcrom® Plus film on request, with a minimum order of 500 meters €/m

Adhesive for skirting boards see page 249

For customizations with decors that are not in our database, there is an extra of € for decor.

PVC Line 8613 is a foam PVC skirting board covered with Alcrom® Plus film, suitable for wooden floors. It can be fixed to the wall with adhesive (like MS 45 or MS 55) or fixing clip 8608/C.



8613 foam PVC covered with Alcrom® Plus film - decor 96

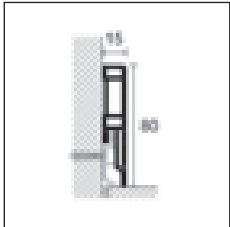

8613

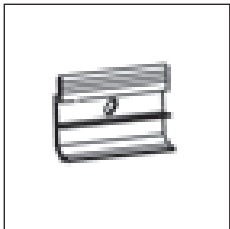

8608/C

PVC LINE

length = 250 cm - pack 20 pcs

FOAM PVC COVERED WITH ALCROM® PLUS FILM

H = 80 mm

| ART. | decors | | decors | |
|---------------|-------------------------------|-------|--------|-------|
| | 05 | 30060 | 580 | 30076 |
| | 08 | 30061 | 1202 | 30078 |
| | 12 | 30062 | 1203 | 30079 |
| | 13 | 30063 | 1204 | 30080 |
| | 14 | 30064 | 1205 | 30081 |
| | 19 | 30065 | 1206 | 30082 |
| | 26 | 30066 | 1207 | 30083 |
| | 31 | 30094 | 1208 | 30084 |
| 8613 | 32 | 30067 | 1209 | 30085 |
| | 36 | 30068 | 1210 | 30086 |
| | 39 | 30069 | 1211 | 30087 |
| | 40 | 30070 | 1212 | 30088 |
| | 41 | 30071 | 1213 | 30089 |
| | 77 | 30072 | 1214 | 30090 |
| | 89 | 30073 | 1215 | 30091 |
| | 91 | 30074 | 1216 | 30092 |
| | 93 | 30075 | 1217 | 30093 |
| | 96 white RAL 9010 embossed | 29971 | | |
| euro/m | | | | |
| 8613 | 99 brushed silver | 29974 | | |
| | 100 brushed steel | 29975 | | |
| euro/m | | | | |

no partial packaging

FIXING CLIPS FOR ART. 8613

pack of 100 pcs

8608/C
euro/pack

29751

no partial packaging



8613 covered with Alcrom® Plus film - decor 100 brushed steel

Customized PDS decors on request for 8613 with a minimum order of 500 meters.

For customizations with decors that are not in our database, there is an extra of € for decor.

skirting board

pvc line

PVC Line 8612 is a foam PVC skirting board covered with Alcrom® Plus film, suitable for both ceramic and LVT floors. It can be fixed to the wall with adhesive (like MS 45 or MS 55).



8612/10 foam PVC covered with Alcrom® Plus film - decor 96

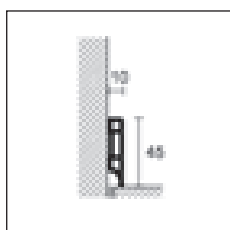

8612/10



PVC LINE

length 250 cm - pack 20 pcs

FOAM PVC COVERED WITH ALCROM® PLUS FILM

H = 45 mm

ART. decors

96 white RAL 9010 embossed 29970

euro/m

8612/10 99 brushed silver 29968

100 brushed steel 29967

euro/m

no partial packaging

PVC Line 8614 is a foam PVC skirting board covered with white Alcrom® Plus film, suitable in case of refurbishment if you want to cover the old skirting boards that are still fixed to the wall. It can be fixed to the old skirting board with adhesive (like MS 45 or MS 55).



8614 foam PVC covered with Alcrom® Plus film - decor 96

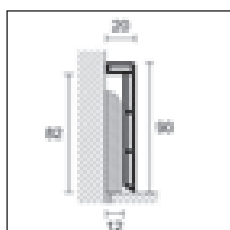

8614



PVC LINE

length = 250 cm - pack 20 pcs

FOAM PVC COVERED WITH ALCROM® PLUS FILM

H = 90 mm

ART. decors

96 white RAL 9010 embossed 29972

euro/m

no partial packaging

8612 and 8614 can be covered with customised Alcrom® Plus film on request, with a minimum order of 500 meters.

For customizations with decors that are not in our database, there is an extra of € for decor.

PVC Line 8600 is a foam PVC skirting board, particularly suitable for DIY installations thanks to its quick and easy application. It is available in different colours and can be fixed with adhesive (like MS 45 or MS 55).

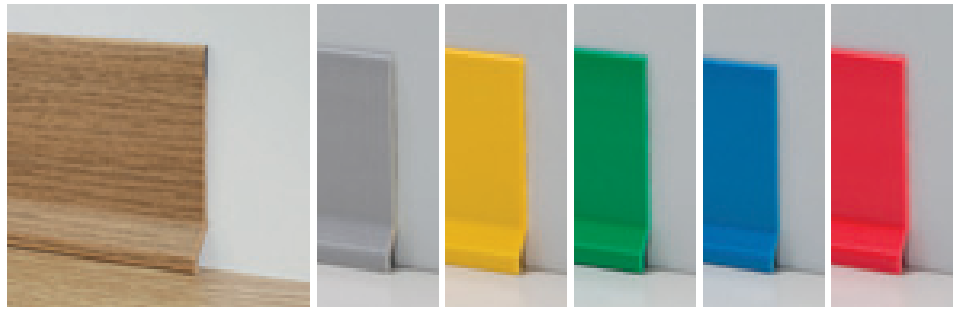

8600 foam PVC decor 532

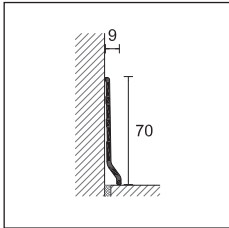

8600



PVC LINE

length 200 cm - pack 20/100 pcs

FOAM PVC

H = 70 mm

| ART. | decors | | decors | | decors | | decors | |
|-------------|--------|-------|----------------|-------|----------------|-------|------------|-------|
| | 518 | 29762 | 536 | 29782 | yellow 561 | 29802 | silver 559 | 29800 |
| | 520 | 29764 | 540 | 29784 | green 562 | 29804 | | |
| | 524 | 29766 | 542 | 29786 | light blue 563 | 29801 | | |
| | 525 | 29768 | 544 | 29788 | red 564 | 29803 | | |
| 8600 | 528 | 29770 | 545 | 29790 | | | | |
| | 530 | 29772 | white 555 | 29792 | | | | |
| | 531 | 29774 | light grey 556 | 29794 | | | | |
| | 532 | 29776 | black 557 | 29796 | | | | |
| | 533 | 29778 | anthracite 558 | 29798 | | | | |
| | 534 | 29780 | | | | | | |

pack 20 pcs

euro/m

pack 100 pcs

euro/m

no partial packaging

external corner profiles available in the same decors, see page 45

To order 8600 in pack of 100 pcs mark /100 after the article code (for example 29778 becomes 29778/100).

PVC Line 8181 is a 70 mm high skirting board in plastic-coated PVC, characterized by a special shape that makes it suitable for installation on curved walls. 8181 is particularly suitable for DIY installation, thanks to its quick and easy application. Available in different colours, it must be fixed to the wall with adhesive.



8181 white PVC

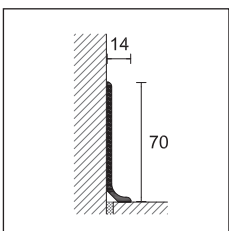

8181



PVC LINE

length = 250 cm - pack 12 pcs

PLASTIC-COATED PVC

H = 70 mm

| ART. | decors | | |
|-------------|--------|--|-------|
| | white | | 19216 |
| | grey | | 19217 |
| 8181 | black | | 19218 |

euro/m

no partial packaging

Art. 8181 should be stored horizontally.

skirting board

pvc line

PVC Line 8596 and 8598 are two impact-resistant skirting boards in foam PVC. The upper part resting on the wall and the lower part resting on the floor are in soft material and allow a perfect adhesion even to surfaces that are not perfectly planar, maintaining speed and simplicity of application. They are available in different colours and can be fixed with adhesive (like MS 45 or MS 55).



8596 Foam PVC decor 545

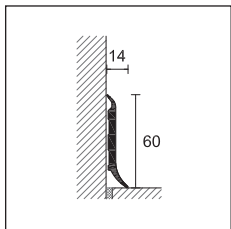

8596



PVC LINE

length = 250 cm - pack 40 pcs

FOAM PVC

H = 60 mm

| ART. | decors | | decors | | decors | |
|------|--------|-----------|--------|-----------|--------|----------------------|
| 8596 | | 518 30800 | | 531 30812 | | 542 30824 |
| | | 524 30804 | | 532 30814 | | 545 30828 |
| | | 525 30806 | | 533 30816 | | white 555 30830 |
| | | 528 30808 | | 536 30820 | | light grey 556 30832 |
| | | 530 30810 | | 540 30822 | | black 557 30834 |

euro/m

no partial packaging

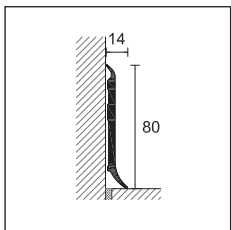

8598

PVC LINE

length = 250 cm - pack 40 pcs

FOAM PVC

H = 80 mm

| ART. | decors | |
|------|--------|----------------------|
| 8598 | | white 555 30880 |
| | | light grey 556 30882 |
| | | black 557 30884 |

euro/m

no partial packaging

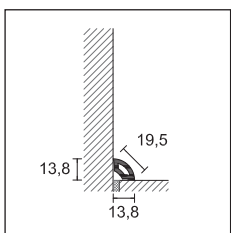

8580

PVC LINE

length = 250 cm - pack 80 pcs

FOAM PVC

| ART. | decors | | decors | |
|------|--------|-----------|--------|----------------------|
| 8580 | | 532 30764 | | white 555 30780 |
| | | 542 30774 | | light grey 556 30782 |
| | | 545 30778 | | black 557 30784 |

euro/m

no partial packaging

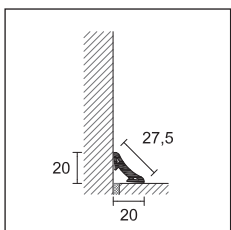

8582

PVC LINE

length = 250 cm - pack 60 pcs

FOAM PVC

| ART. | decors | | decors | |
|------|--------|-----------|--------|----------------------|
| 8582 | | 532 30714 | | white 555 30730 |
| | | 542 30724 | | light grey 556 30732 |
| | | 545 30728 | | black 557 30734 |

euro/m

no partial packaging

PVC Line 8602 is an impact-resistant and 48-mm high skirting board in foam PVC. It is particularly suitable for DIY installation, thanks to the speed and easiness of application. It is available in different colours and it is installed with a simple interlocking system with harmonic steel clips. In addition to their decorative function, it allows to hide the expansion gap perimeter of floating wood and laminate floors.

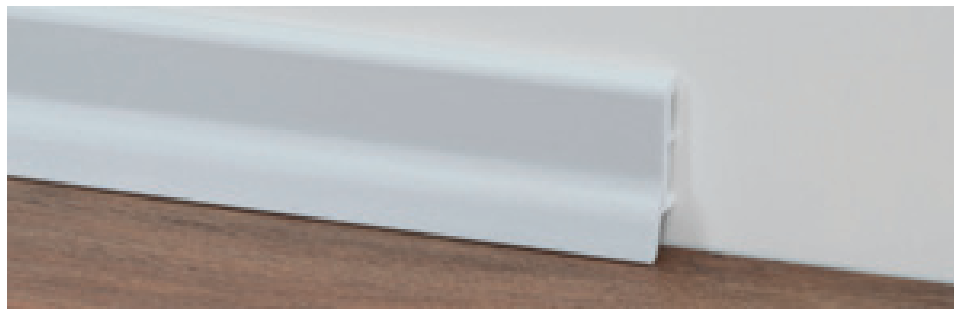

8602 Foam PVC

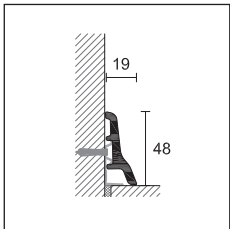

8602



PVC LINE

length 250 cm - pack 40 pcs

FOAM PVC

H = 48 mm

| ART. | decors | |
|------|----------------|-------|
| 8602 | white 555 | 29530 |
| | light grey 556 | 29532 |
| | black 557 | 29534 |

euro/m

no partial packaging

INSIDE CORNER

pack 10 pcs

POLYPROPYLENE

H = 48 mm

| ART. | decors | |
|--------|----------------|-------|
| 8602/I | white 555 | 29578 |
| | light grey 556 | 29580 |
| | black 557 | 29582 |

euro/pc

no partial packaging

OUTSIDE CORNER

pack 10 pcs

POLYPROPYLENE

H = 48 mm

| ART. | decors | |
|--------|----------------|-------|
| 8602/E | white 555 | 29628 |
| | light grey 556 | 29630 |
| | black 557 | 29632 |

euro/pc

no partial packaging

RIGHT/LEFT END CAPS

pack 10 pcs

POLYPROPYLENE

H = 48 mm

| ART. | decors | |
|--------------|----------------|-------|
| 8602/P dx/sx | white 555 | 29728 |
| | light grey 556 | 29730 |
| | black 557 | 29732 |

euro/pc

no partial packaging

FIXING CLIPS

10 blister packs / 20 pcs/blister

8602/C 29750

euro/blister

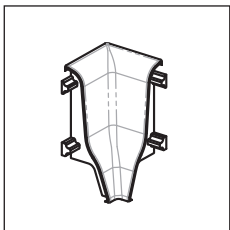

8602/I

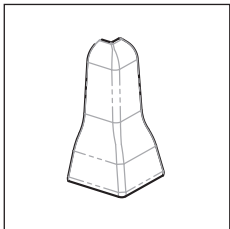

8602/E

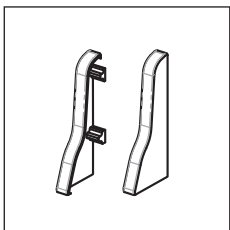

8602/P



8602/C fixing clips

skirting board

pvc line

PVC Line 8603 is an impact-resistant and 70-mm high skirting board in foam PVC. It is particularly suitable for DIY installation, thanks to the speed and easiness of application. It is available in different colours and it can be installed with a simple interlocking system with harmonic steel clips. In addition to its decorative function, it allows to hide the expansion gap perimeter of floating wood and laminate floors.



8603 Foam PVC decor 555

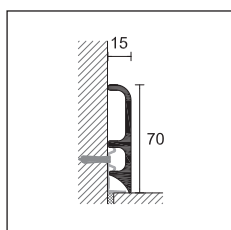

8603



PVC LINE

length 250 cm - pack 40 pcs

FOAM PVC

H = 70 mm

| ART. | decors | |
|------|--|-------|
| 8603 |  532 | 30144 |
| |  542 | 30154 |
| |  545 | 30158 |
| |  white 555 | 30160 |
| |  light grey 556 | 30162 |
| |  black 557 | 30164 |

euro/m

no partial packaging

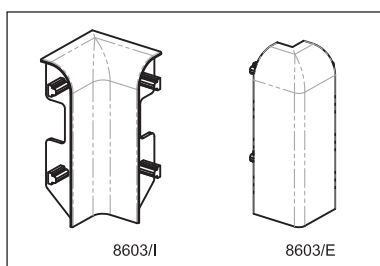

8603/I







8603/E

INSIDE CORNER

pack 10 pcs

POLYPROPYLENE

H = 70 mm

| ART. | decors | |
|--------|--|-------|
| 8603/I |  532 | 30194 |
| |  542 | 30204 |
| |  545 | 30208 |
| |  white 555 | 30210 |
| |  light grey 556 | 30212 |
| |  black 557 | 30214 |

euro/pc







no partial packaging

OUTSIDE CORNER

pack 10 pcs

POLYPROPYLENE

H = 70 mm

| ART. | decors | |
|--------|--|-------|
| 8603/E |  532 | 30244 |
| |  542 | 30254 |
| |  545 | 30258 |
| |  white 555 | 30260 |
| |  light grey 556 | 30262 |
| |  black 557 | 30264 |

euro/pc

no partial packaging

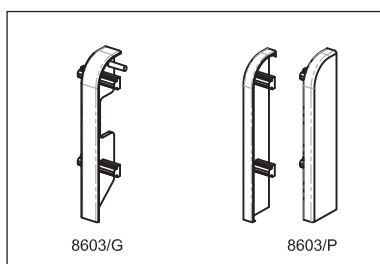

8603/G







8603/P

JUNCTION

pack 10 pcs

POLYPROPYLENE

H = 70 mm

| ART. | decors | |
|--------|--|-------|
| 8603/G |  532 | 30294 |
| |  542 | 30304 |
| |  545 | 30308 |
| |  white 555 | 30310 |
| |  light grey 556 | 30312 |
| |  black 557 | 30314 |

euro/pc







no partial packaging

RIGHT/LEFT END CAPS

pack 10 pcs

POLYPROPYLENE

H = 70 mm

| ART. | decors | |
|-----------------|--|-------|
| 8603/P dx/sx |  532 | 30344 |
| |  542 | 30354 |
| |  545 | 30358 |
| |  white 555 | 30360 |
| |  light grey 556 | 30362 |
| |  black 557 | 30364 |

euro/pc

no partial packaging



8602/C fixing clips

FIXING CLIPS

10 blister packs / 20 pcs/blister

8602/C

29750

euro/blister

PVC Line 8607 is an impact-resistant and 70-mm high skirting board in foam PVC. It is particularly suitable for DIY installation, thanks to the speed and easiness of application. It is available in different colours and it can be installed with a simple interlocking system with harmonic steel clips. In addition to its decorative use, it allows to hide the expansion gap perimeter of floating wood and laminate floors.



8607 Foam PVC decor 532

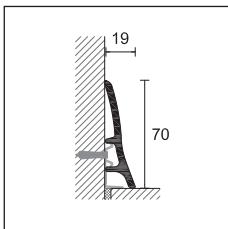

8607



PVC LINE

length 250 cm - pack 40 pcs

FOAM PVC

H = 70 mm

| ART. | decors | |
|------|----------------|-------|
| 8607 | 532 | 30414 |
| | 542 | 30424 |
| | 545 | 30428 |
| | white 555 | 30430 |
| | light grey 556 | 30432 |
| | black 557 | 30434 |

euro/m

no partial packaging

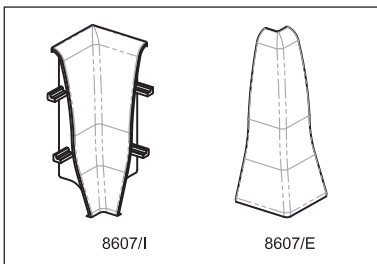

INSIDE CORNER

pack 10 pcs

POLYPROPYLENE

H = 70 mm

| ART. | decors | |
|--------|----------------|-------|
| 8607/I | 532 | 30464 |
| | 542 | 30474 |
| | 545 | 30478 |
| | white 555 | 30480 |
| | light grey 556 | 30482 |
| | black 557 | 30484 |

euro/pc

no partial packaging

OUTSIDE CORNER

pack 10 pcs

POLYPROPYLENE

H = 70 mm

| ART. | decors | |
|--------|----------------|-------|
| 8607/E | 532 | 30514 |
| | 542 | 30524 |
| | 545 | 30528 |
| | white 555 | 30530 |
| | light grey 556 | 30532 |
| | black 557 | 30534 |

euro/pc

no partial packaging

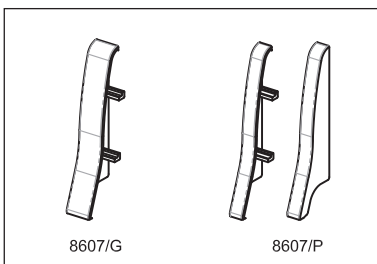

JUNCTION

pack 10 pcs

POLYPROPYLENE

H = 70 mm

| ART. | decors | |
|--------|----------------|-------|
| 8607/G | 532 | 30564 |
| | 542 | 30574 |
| | 545 | 30578 |
| | white 555 | 30580 |
| | light grey 556 | 30582 |
| | black 557 | 30584 |

euro/pc

no partial packaging

RIGHT/LEFT END CAPS

pack 10 pcs

POLYPROPYLENE

H = 70 mm

| ART. | decors | |
|----------------|----------------|-------|
| 8607P dx/sx | 532 | 30614 |
| | 542 | 30624 |
| | 545 | 30628 |
| | white 555 | 30630 |
| | light grey 556 | 30632 |
| | black 557 | 30634 |

euro/pc

no partial packaging



8602/C fixing clips

FIXING CLIPS

10 blister packs / 20 pcs/blister

8602/C 29750

euro/blister

skirting board

pvc line

PVC Line 148 is a skirting board for carpet and PVC coverings, composed of a base in rigid PVC and clip in soft PVC. Used as internal corner connection profile, it creates a curvature on the corner once the covering has been laid. It also allows to finish and cover the extremities of the carpet or the PVC covering, thus covering any cutting inaccuracies. This profile is recommended for public spaces such as hospitals and schools.



172 PVC white

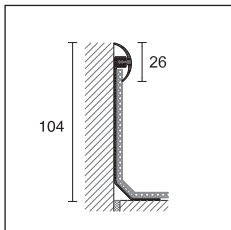

148/B +
148/C

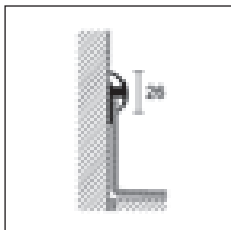

148/BR +
148/C

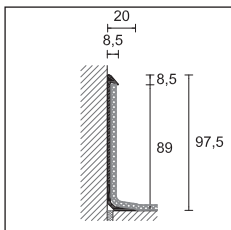

172

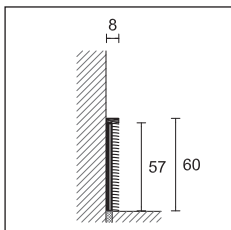

173

PVC LINE - BASE

length = 300 cm - pack 30 pcs

ART. finishing

WHITE RIGID PVC

| | | | |
|--------|---------------|--------------------------|-------|
| 148/B | PVC white | <input type="checkbox"/> | 19095 |
| | <i>euro/m</i> | | |
| 148/BR | PVC white | <input type="checkbox"/> | 19094 |
| | <i>euro/m</i> | | |

no partial packaging

PVC LINE - CLIP

length = 305 cm - pack 30 pcs

ART. finishing

PVC MORBIDO

| | | | |
|-------|---------------|--------------------------|-------|
| 148/C | PVC white | <input type="checkbox"/> | 19096 |
| | PVC ash grey | <input type="checkbox"/> | 19097 |
| | PVC sand | <input type="checkbox"/> | 19098 |
| | <i>euro/m</i> | | |

no partial packaging

PVC LINE

length = 300 cm - pack 20 pcs

ART. finishing

PVC

| | | | |
|-----|---------------|--------------------------|-------|
| 172 | PVC white | <input type="checkbox"/> | 19210 |
| | <i>euro/m</i> | | |

no partial packaging

length = 300 cm - pack 20 pcs

ART. finishing

ALUMINIUM

| | | | |
|-----|-------------------------|--------------------------|-------|
| 173 | silver anodised drilled | <input type="checkbox"/> | 19215 |
| | <i>euro/m</i> | | |

no partial packaging

ADHESIVE

Cartridges 12 pcs - 300 ml (MS 45) and 290 ml (MS 55)

ART.

| | | | |
|----------------|-------|--------------------------|-----------|
| MAPEFLEX MS 45 | white | <input type="checkbox"/> | 6PB010043 |
| MAPEFLEX MS 55 | white | <input type="checkbox"/> | 6PV010043 |

For further information, please see Mapei price list.

148/C is available in different colours on request

PVC Line 170, 169 and 171 are cove-shaped connection profiles in plastic-coated PVC. Recommended for the laying of carpet and PVC coverings, they even out the curvature between the floor and the wall.



171 black PVC

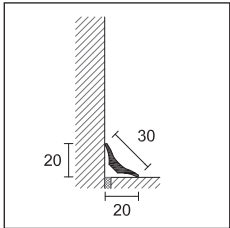

170



PVC LINE - COVE-SHAPED

length = 200 cm - pack 50 pcs

H

ART. finishing

20

PVC

170 black
euro/m

19200

no partial packaging

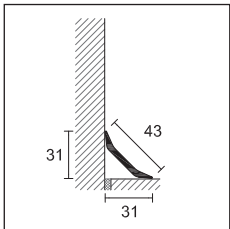

169

PVC LINE - COVE-SHAPED

length = 200 cm - pack 50 pcs

H

ART. finishing

31

PVC

169 black
euro/m

19195

no partial packaging

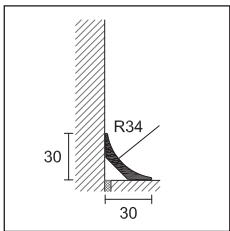

171

PVC LINE - COVE-SHAPED

length = 200 cm - pack 30 pcs

H

ART. finishing

30

PVC

171 black
euro/m

19205

no partial packaging





prolight

Prolight is a line of light profiles with direct and indirect lighting. The integration of the LED technology with Profilpas profiles allows to customize every space. Available in warm, neutral or RGB light and provided with dimmer, they are easy to install and give the suitable light for each use, from the spaces for relaxation to work ones.

Prolight Prolist LLA and LLB are two aluminium decorative listellos with direct LED light. Suitable for framing mirrors and walls and illuminating recessed niches and shelves, these profiles add value to the space, finding an ideal location in bathrooms, kitchens and private space in general. Prolight Prolist LLA/20/10, in particular, is perfect for shower recessed niches to create pleasant plays of light.



LLA/20/10 silver anodised aluminium

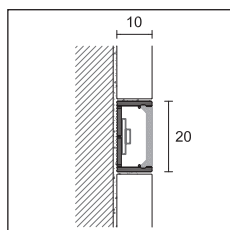

LLA/20



PROLIGHT PROLIST

length = 270 cm - pack 10 pcs **LxH**

ART. finishing **20x10**

ALUMINIUM

LLA/20 silver anodised  **84070**
euro/m

individually packed

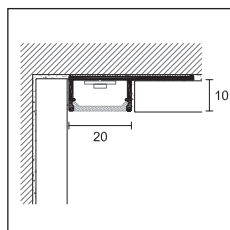

LLA/20/10

PROLIGHT PROLIST

length = 270 cm - pack 10 pcs **H**

ART. finishing **10**

ALUMINIUM

LLA/20/10 silver anodised  **84076**
euro/m

individually packed

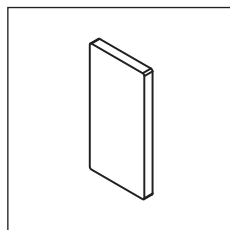

LLA/20P

END CAPS FOR LLA/20 AND LLA/20/10

pack 5 pcs

ART. finishing

ALUMINIUM

LLA/20P silver anodised  **84072**
euro/pc

no partial packaging

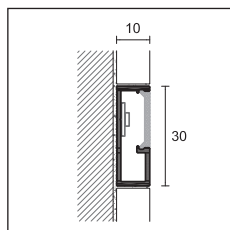

LLA/30
LLB/30

PROLIGHT PROLIST

length = 270 cm - pack 10 pcs **LxH**

ART. finishing **30x10**

ALUMINIUM

LLA/30 silver anodised  **84080**
euro/m

LLB/30 bright polished silver  **84081**
euro/m

individually packed

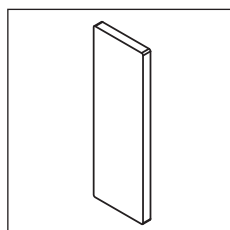

LLA/30P
LLB/30P

END CAPS FOR LLA/30 AND LLB/30

pack 5 pcs

ART. finishing

ALUMINIUM

LLA/30P silver anodised  **84082**
euro/pc

LLB/30P bright polished silver  **84083**
euro/pc

no partial packaging

Spare insert in opaline ABS for art. LLA/20, LLA/20/10, LLA/30 and LLB/30 code 84069 L 270 cm - pack 20 pcs euro/m

For the best aesthetic result and the validity of the warranty, we suggest the exclusive use of our electrical components. See page 236

We recommend the use of NT LED strip with continuous light, see page 236

Prolight Prolist TLA is an aluminium decorative listello with indirect LED light, suitable for framing mirrors or outlining walls and coverings.
Prolight Prolist CLA is ideal under wall cabinets, in kitchens, bathrooms, wardrobes and showcases.

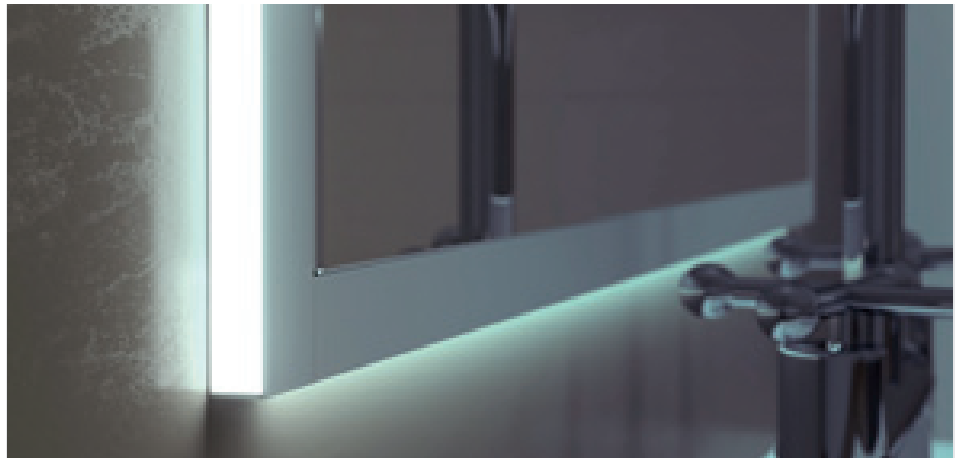

TLA/10/C1 silver anodised aluminium

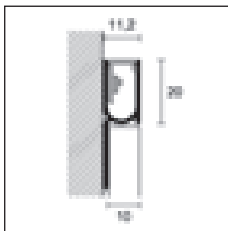

TLA/10/C1
TLB/10/C1



PROLIGHT PROLIST

length = 270 cm - pack 10 pcs

| ART. | finishing | LxH |
|------------------|---|-------|
| ALUMINIUM | | |
| TLA/10/C1 | silver anodised <i>euro/m</i> | 84090 |
| TLB/10/C1 | bright polished silver <i>euro/m</i> | 84091 |

individually packed

END CAPS FOR TLA/10/C1

pack 5 pcs

| ART. | finishing | |
|------------------|--|-------|
| ALUMINIUM | | |
| TLA/10P/C1 | silver anodised <i>euro/pc</i> | 84092 |
| TLB/10P/C1 | bright polished silver <i>euro/pc</i> | 84093 |

no partial packaging

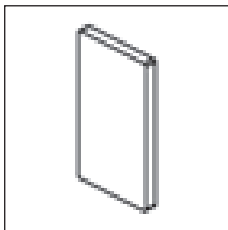

TLA/10P/C1
TLB/10P/C1

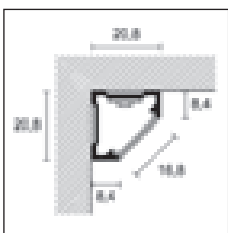

CLA/8
CLA/8A



PROLIGHT PROLIST

length = 270 cm - pack 10 pcs

| ART. | finishing | H |
|------------------|---|-------|
| ALUMINIUM | | |
| CLA/8 | silver anodised <i>euro/m</i> | 84221 |
| CLA/8A | silver anodised adesivo <i>euro/m</i> | 84222 |

individually packed

END CAPS FOR CLA/8

pack 5 pcs

| ART. | finishing | H |
|------------------|-----------------------------------|-------|
| ALUMINIUM | | |
| CLA/8P | silver anodised <i>euro/pc</i> | 84223 |

no partial packaging

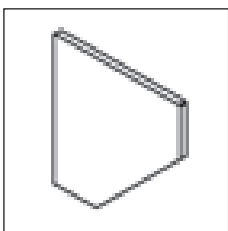

CLA/8P

Spare insert in opaline ABS for art. CLA/8 and CLA/8A code 84069 L 270 cm - pack 20 pcs euro/m

For the best aesthetic result and the validity of the warranty, we suggest the exclusive use of our electrical components. See page 236

We recommend the use of NT LED strip with continuous light, see page 236

Prolight Prolist Q LQL/2 is an aluminium decorative listello with indirect LED light that, thanks to its particular section, creates a delicate and elegant light effect on the ceramic coverings, thus embellishing the wall. This profile is available in a wide range of colours including white stone, five original cement effects, two special metal tonalities and a white characterized by an extremely solid and full colour.



LQL/2 metal light colour-coated aluminium

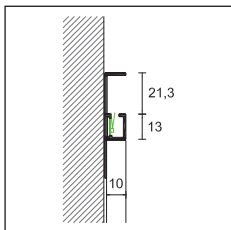

LQL/2



TREND
COLOR

PROLIGHT PROLIST Q









length = 270 cm - pack 5 pcs

H

ART. finishing

10

COLOUR-COATED ALUMINIUM

| | | |
|---------------------------|---|-------|
| white stone |  | 84020 |
| concrete white |  | 84021 |
| concrete graphite |  | 84022 |
| concrete smoke |  | 84023 |
| LQL/2 concrete mud |  | 84024 |
| concrete sand |  | 84025 |
| metal dark |  | 84026 |
| metal light |  | 84027 |
| solid white |  | 84028 |

euro/m

individually packed

ELECTRICAL COMPONENTS AND ACCESSORIES FOR LIGHTING

| ART. | description | |
|-------------------|--|-------|
| L5/NW/65 L | spool 5 m LED strips, lateral light, neutral colour 4000 °K, 9,6W/m IP65 | 84136 |
| | euro/mt (euro/pack) | |

For the best aesthetic result and the validity of the warranty, we suggest the exclusive use of our electrical components. See page 236

Prolight Proangle Q ZQAL is a natural aluminium profile for external corners. Equipped with a diffuser in different colours, it helps increasing safety in public and private spaces through a thin luminous line.

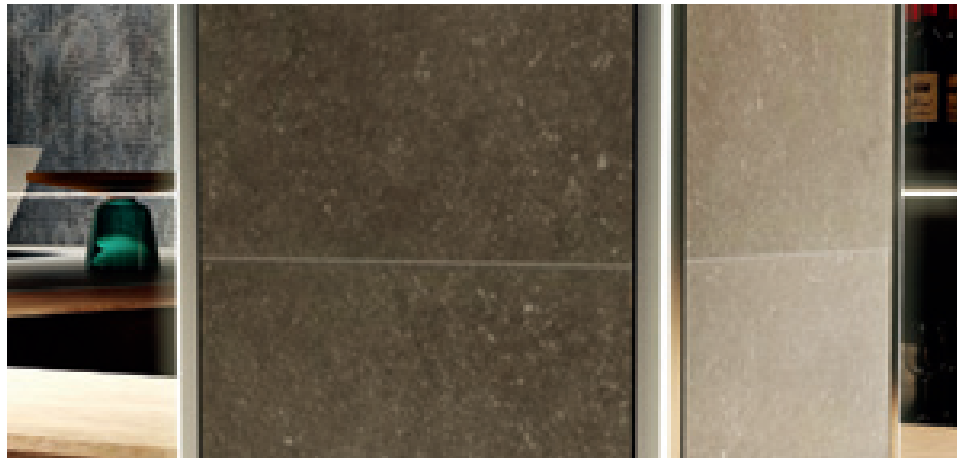

ZQAL/10B natural aluminium + ZQAL/10 white opaline PVC

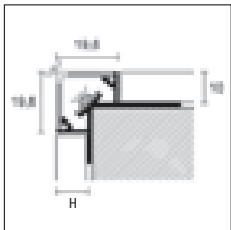

ZQAL/...B+ZQAL/10



PROLIGHT PROANGLE Q

length = 270 cm - pack 10 pcs

| | | H | |
|--------------------|------------------------|-------|-------|
| ART. | finishing | 10 | 13 |
| ALUMINIUM | | | |
| ZQAL/10B | natural aluminium base | 87226 | |
| | <i>euro/m</i> | | |
| ZQAL/13B | natural aluminium base | | 87227 |
| | <i>euro/m</i> | | |
| OPALINE PVC | | | |
| | white | | 87230 |
| ZQAL/10 | grey | | 87231 |
| | red | | 87232 |
| | yellow | | 87233 |
| | <i>euro/m</i> | | |

Items available in different colours on demand minimum quantity 540 meters

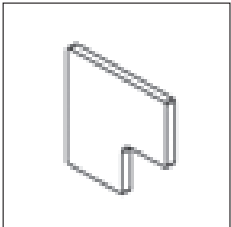

ZQAL/...P

END CAPS FOR ZQAL

pack 5 pcs

| | | H | |
|------------------|-------------------|-------|-------|
| ART. | finishing | 10 | 13 |
| ALUMINIUM | | | |
| ZQAL/10P | natural aluminium | 87229 | |
| | <i>euro/pc</i> | | |
| ZQAL/13P | natural aluminium | | 87228 |
| | <i>euro/pc</i> | | |

no partial packaging

For the best aesthetic result and the validity of the warranty, we suggest the exclusive use of our electrical components. See page 236

We recommend the use of NT LED strip with continuous light, see page 236

cerfix® prostep - protect

Prolight Prostep SGA is an aluminium profile with indirect LED light for the protection and finishing of ceramic, marble and stone steps. With SGA, the light diffuses softly downwards, giving elegance and refinement to the stair, as well as increasing the safety of the space.

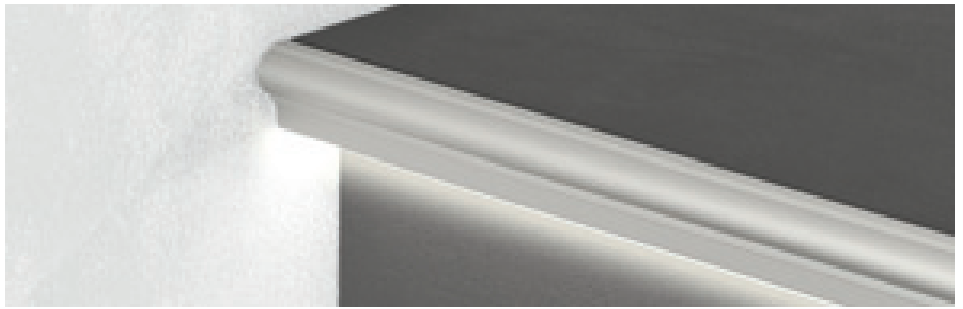

SGA/11L silver anodised aluminium

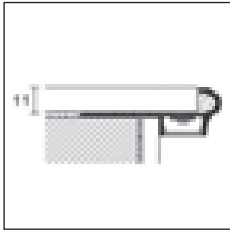

SGA/11L



PROLIGHT PROSTEP

length = 270 cm - pack 10 pcs

H mm

ART. finishing

11

ALUMINIUM

SGA/11L silver anodised
euro/m

94969

individually packed

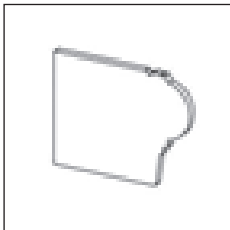

SGA/11P

END CAPS FOR PROFILE SGA/11L

pack 5 pcs

H mm

ART. finishing

11

ALUMINIUM

SGA/11P silver anodised
euro/pc

94964

no partial packaging

Prolight Protect G/9 is a stair nosing profile in aluminium equipped with direct LED light and a non-slip knurled surface. G/9 is suitable for public spaces such as cinemas, offices, theatres, clubs and boats, making them welcoming and elegant at the same time.



G/9/SF silver anodised aluminium

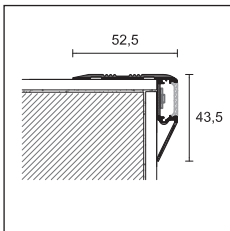

G/9/F



PROLIGHT PROTECT

length = 270 cm - pack 10 pcs

ART. finishing

ALUMINIUM

G/9/F silver anodised
euro/m

84050

individually packed

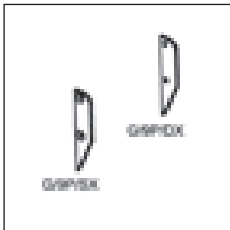

G/9P/

END CAPS FOR PROFILE G/9/F

pack 5 pcs

ART. finishing

ALUMINIUM

G/9P/DX silver anodised
euro/pc

84052

G/9P/SX silver anodised
euro/pc

84053

no partial packaging

Spare insert in opaline ABS for art. SGA/11L and G/9/F code 84069 L 270 cm - pack 20 pcs euro/m

For the best aesthetic result and the validity of the warranty, we suggest the exclusive use of our electrical components. See page 236

We recommend the use of NT LED strip with continuous light, see page 236

Prolight Protect 126/L/F is an aluminium stair nosing profile equipped with direct LED light and replaceable rubber insert. 126/L/F is suitable for public spaces such as cinemas, offices, theatres, clubs and boards, making them welcoming and elegant at the same time.



126/L/F silver anodised aluminium + GMR/44 black striped rubber

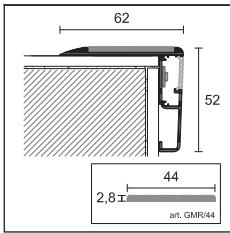

126/L/F



PROLIGHT PROTECT

length = 270 cm - pack 6 pcs

ART. finishing

ALUMINIUM

| | | | |
|----------------|-----------------|---|-------|
| 126/L/F | silver anodised |  | 84060 |
| | <i>euro/m</i> | | |

individually packed

GROOVED RUBBER

length = 1700 cm - 1 rolls pack

ART.

| | | | |
|---------------|---------------|---|-------|
| GMR/44 | black |  | 75706 |
| | <i>euro/m</i> | | |

END CAPS FOR 126/L/F

pack 5 pcs

ART. finishing

ALUMINIUM

| | | | |
|------------------|-----------------|---|-------|
| 126/LP/DX | silver anodised |  | 84062 |
| | <i>euro/pc</i> | | |

| | | | |
|------------------|-----------------|---|-------|
| 126/LP/SX | silver anodised |  | 84063 |
| | <i>euro/pc</i> | | |

no partial packaging

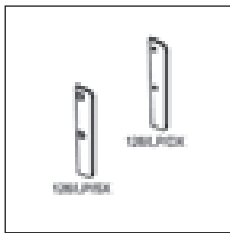

126/LP

Spare insert in opaline ABS for art. 126/L/F code 84069 L 270 cm - pack 20 pcs euro/m

For the best aesthetic result and the validity of the warranty, we suggest the exclusive use of our electrical components. See page 236

We recommend the use of NT LED strip with continuous light, see page 236



metal line S

Prolight Metal Line SKL/2 is a skirting board in aluminium with indirect LED light. Its special section allows to create an original play of light along the wall, thus adding value to the whole surface. In addition to the silver anodised and the white stone versions, SKL/2 is available in 8 finishes: a range of colours including five original cement effects, two special metal tonalities and a white characterized by an extremely solid and full colour.



SKL/2 concrete white colour-coated aluminium

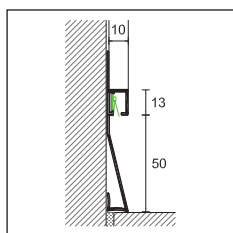

SKL/2



TREND
COLOR

PROLIGHT METAL LINE S

length = 270 cm - pack 5 pcs

H

ART. finishing

10

ALUMINIUM

| | | |
|---------------|-----------------|-------|
| SKL/2 | silver anodised | 78579 |
| <i>euro/m</i> | | |

COLOUR-COATED ALUMINIUM

| | | |
|---------------|-------------------|-------|
| SKL/2 | white stone | 78591 |
| | concrete white | 78592 |
| | concrete graphite | 78593 |
| | concrete smoke | 78594 |
| | concrete mud | 78595 |
| | concrete sand | 78596 |
| | metal dark | 78597 |
| | metal light | 78598 |
| | solid white | 78599 |
| <i>euro/m</i> | | |

individually packed

ELECTRICAL COMPONENTS AND ACCESSORIES FOR LIGHTING

| ART. | description | |
|----------------------------|--|-------|
| L5/NW/65 L | spool 5 m LED strips, lateral light, neutral colour 4000 °K, 9,6W/m IP65 | 84136 |
| <i>euro/mt (euro/pack)</i> | | |

For the best aesthetic result and the validity of the warranty, we suggest the exclusive use of our electrical components. See page 236

Metal Line 88/16L/A is a skirting board flush with the wall and with LED lighting system. The light is distributed along the whole length of the profile and passes through a visible gap. There is the possibility to insert the optional dimmer to adjust the light intensity of the skirting board and create both an elegant decoration and a night courtesy light.



88/16L/A silver anodised aluminium

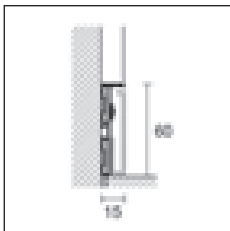

87/6 + 88/16L

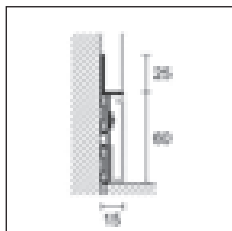

88/6 + 88/16L



88/6E

METAL LINE 87 - 88

length = 200 cm - pack 20 pcs **H cm**

ART. finishing **6**

ALUMINIUM

87/6 natural aluminium (drilled)  78338
euro/m

88/6 natural aluminium (drilled)  78310
euro/m

individually packed

ALUMINIUM INSERT FOR LED LIGHT

length = 200 cm - pack 20 pcs **H cm**

88/16L/A silver anodised  78559
colour-coated matt white  78560
RAL 9010
euro/m

adesivo - individually packed

OUTSIDE CORNER IN METAL

pack 4 pcs **H cm**

ART. finishing **6**

88/6E silver  78561
colour-coated matt white  78562
RAL 9010
euro/pc

no partial packaging

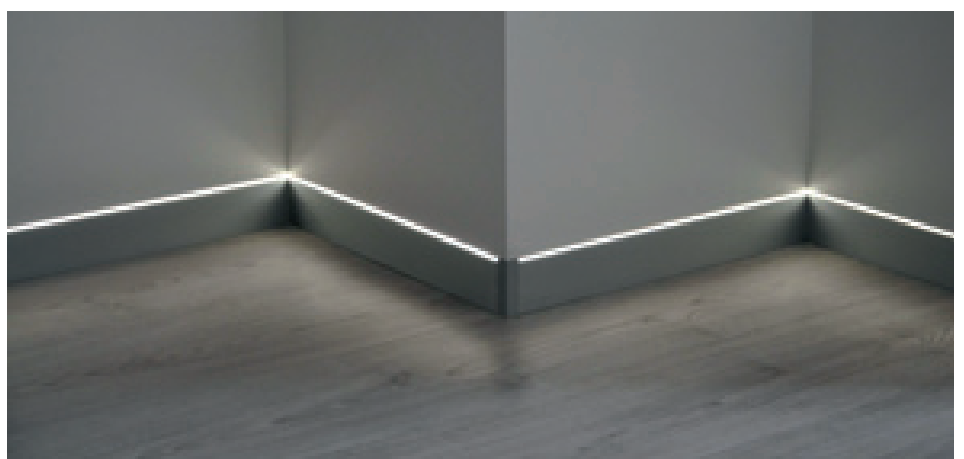

88/6 + 88/16L/A silver anodised aluminium

For the best aesthetic result and the validity of the warranty, we suggest the exclusive use of our electrical components. See page 236

metal line

Prolight Metal Line 89 is a skirting board in anodised aluminium with LED-strip lighting system. The light is distributed along the entire length of the profile through a diffuser element. It is possible to insert the dimmer in order to adjust the luminous intensity of the skirting board to decorate and light up the room.

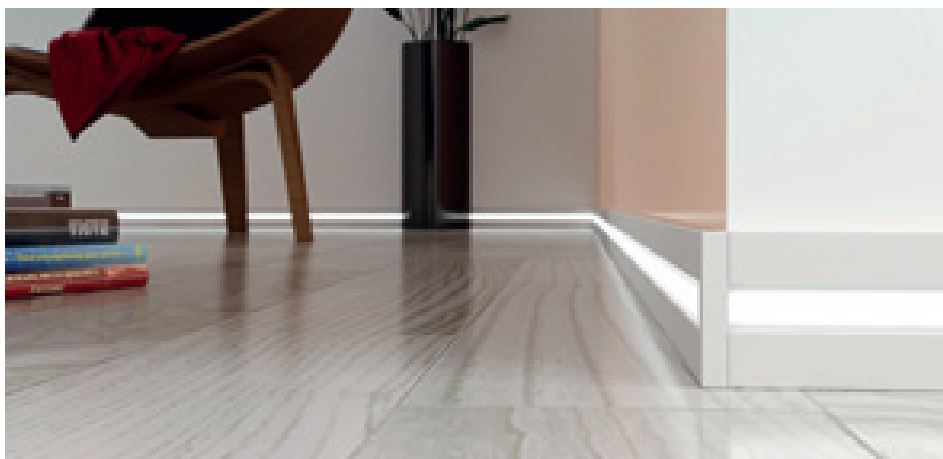

89/6L silver anodised aluminium

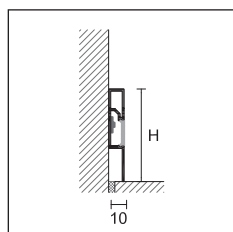

89/6L



PROLIGHT METAL LINE 89

length = 200 cm - pack 25 pcs

H cm

ART. finishing

6

ALUMINIUM

89/6L silver anodised



86000

euro/m

individually packed

INSIDE/OUTSIDE CORNER - RIGHT/LEFT END CAP

pack 4 pcs

H cm

ART. finishing

6

ALUMINIUM

89/6EI silver anodised



78506

euro/pc

no partial packaging



89/6EI

Spare insert in opaline ABS for art. 89/6L code 84069 L 270 cm - pack 20 pcs euro/m

For the best aesthetic result and the validity of the warranty, we suggest the exclusive use of our electrical components. See page 236

We recommend the use of NT LED strip with continuous light, see page 236

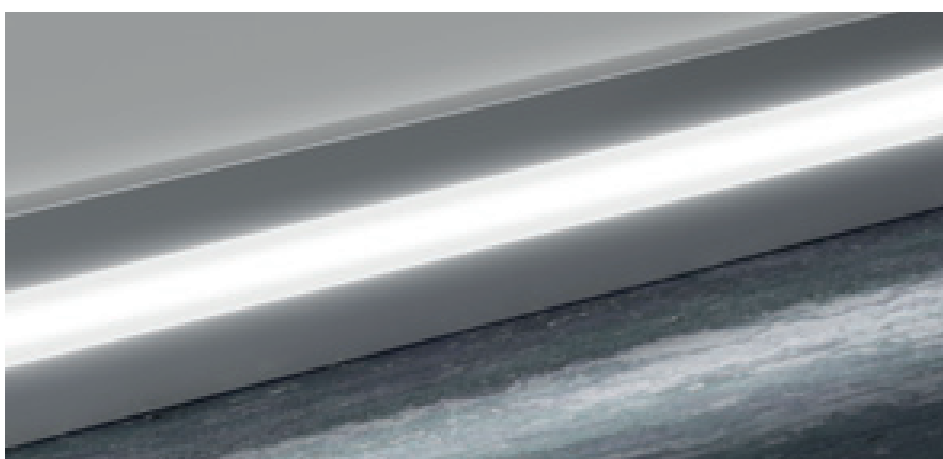

89/6L silver anodised aluminium

HOW TO ORDER THE ELECTRICAL COMPONENTS

LED (white light)

Measure how many meters of LED strip have to be positioned on our profiles. A spool is 5 meters long. Spools have 120 LED every meter. The voltage is 24 volt. The consumption is 9,6 watts every meter. To determine the consumption, length must be multiplied by 9,6 watts.

Example: calculation of the watts consumption = 7,4m x 9,6W = 71 total watts

Choose the colour of the light. LED strips are available in neutral white light (4000 °K) or warm white light (3000 °K).

Choose the degree of protection: IP33 for inside and dry spaces, IP67 for outside or moist spaces.

POWER SUPPLIES

Choose the suitable power supply on the basis of the total watts and so as not to exceed 90% of the maximum power.

Example: 71W : 90 x 100 = 79W - use a power supply of 90W

| | ART. | | |
|----------------------|------|-----------|-------|
| from 5 cm to 5,5 m | 60W | AL/60/24 | 84150 |
| from 5,6 m to 8,4 m | 90W | AL/90/24 | 84152 |
| from 8,5 m to 11,2 m | 120W | AL/120/24 | 84154 |
| from 11,3 m to 14 m | 150W | AL/150/24 | 84156 |

We recommend to power the LED strips every 3 meters in order to avoid differences in brightness and the overheating of the LED in the initial part of them. A cable with 1 mm² section has a maximum range of about 4 Amp and a voltage drop of 1 Volt every 10 meters. For special installations, please contact our Technical Department.

DIMMER (optional)

The dimmer/fader/driver has the function to adjust the light intensity of LED light, it supports maximum 10 Amp to an equal extent of 25 linear meters of our LED strip. It must be placed between the power supply and the LED strip and connected to a switch (not supplied) and/or to the receiver of the remote control (optional).

In case of more lines with simultaneous turning on, the first dimmer is connected in Sync mode and it will switch on the consecutive dimmers.

Example: to connect 3 lines with simultaneous turning on, you need to use 3 dimmers.

REMOTE CONTROL + RECEIVER (optional)

The remote control is a radiofrequency and can control up to 4 channels; it is used to turn on/off the LED.

The receiver must be installed between the power supply and the LED strip or connected to the dimmer if present.

If there is also the dimmer, the remote control can adjust the LED light intensity.

ELECTRICAL CABLES

The cables are necessary to connect the power supply to the LED strips where needed.

A cable with 1 mm² section has a maximum range of about 4 amps and a voltage drop of 1 volt every 10 meters.

CONNECTORS

Art. IR/C01 connects the LED strips to the line of power supply.
Art. IR/W3 connects maximum 3 cables among them.

LED RGB (coloured light)

Measure how many meters of LED strip have to be positioned on our profiles. A spool is 5 meters long. Spools can be cut every 10 cm. The voltage is 24 volt. The consumption is 14,4 watts every meter. To determine the consumption, length must be multiplied by 14,4 watts.

Example: calculation of the watts consumption = 7,4m x 14,4W = 106,6 total watts

RGB LED strips are available in degree of protection IP67, are covered with silicone sheath and are provided with adhesive for the fastening in inside or outside spaces.

POWER SUPPLIES

Choose the suitable power supply on the basis of the total watts and so as not to exceed 90% of the maximum power.

Example: 106,60W : 90 x 100 = 118W - use a power supply of 120W

| | ART. | | |
|---------------------|------|-----------|-------|
| from 10 cm to 3,7 m | 60W | AL/60/24 | 84150 |
| from 3,8 m to 5,5 m | 90W | AL/90/24 | 84152 |
| from 5,6 m to 7,5 m | 120W | AL/120/24 | 84154 |
| from 7,6 m to 9,3 m | 150W | AL/150/24 | 84156 |

We recommend to power the LED strips every 3 meters in order to avoid differences in brightness and the overheating of the LEDs in the initial part. A cable with 1 mm² section has a maximum range of about 4 amp and a voltage drop of 1 volt every 10 meters. For length over 9,3 meters, see SLAVE paragraph. For special installations, please contact our Technical Department.

REMOTE CONTROL

The remote control is a radiofrequency and can control up to 4 channels; it is used to turn on/off the LED, adjust light intensity and choose the colour or the sequence of LEDs.

MASTER CONTROL UNIT

Connected with the remote control, it is used to turn on/turn off/adjust light intensity and to choose the colour or the sequence of LEDs.

It must be connected between the power supply and the LED strip.

SLAVE CONTROL UNIT

Every time that the system needs more lines controlled by just one unit, there is the need to add 1 slave for every added line.

Example: to connect 3 lines with simultaneous lighting, you need to use 1 master control unit and 2 slave control units.

The slave control unit must be connected to the master control unit with RJ11 6-poles cable (not supplied).

ELECTRICAL CABLES

The cable has 4 poles, 3 of them have a 0,5 mm² section (for the three colours), one of them has a 1 mm² section (for the negative pole).

CONNECTORS

Art. IR/C02 connects the LED strips with coloured light to the line of power supply, length of 15 cm.
Art. IR/C03 connects LED strips to LED strips with coloured light, length of 15 cm.

We recommend to assign the assembly of the electrical components to qualified staff.

Electrical components and accessories for Prolight profiles. Each element has to be chosen depending on the established length of the light profiles. It is necessary to calculate the power consumption in W/m for choosing one or more power supplies to be combined with the dimmer and the controller.



spool 5 m NT LED strip



L5/.../33



L5/.../67



AL/.../24

DIMM/02



TEL/04



TEL/RGB/04



RIC/01

ELECTRICAL COMPONENTS AND ACCESSORIES FOR LIGHTING

| ART. | description | |
|------------|---|-------|
| L5/NW/33 | spool 5 m LED strip colour neutral white 4000° K - 9,6W/m - IP33 <i>euro/m (euro/pack)</i> | 84105 |
| L5/WW/33 | spool 5 m LED strip colour warm white 3000° K - 9,6W/m - IP33 <i>euro/m (euro/pack)</i> | 84115 |
| L5/NW/67 | spool 5 m LED strip colour neutral white 4000° K - 9,6W/m - IP67 <i>euro/m (euro/pack)</i> | 84125 |
| L5/WW/67 | spool 5 m LED strip colour warm white 3000° K - 9,6W/m - IP67 <i>euro/m (euro/pack)</i> | 84135 |
| L5/RGB/67 | spool 5 m RGB LED strip - 14,4 W/m - IP67 <i>euro/m (euro/pack)</i> | 84140 |
| L5/NW/65NT | spool 5 m NT LED strip neutral white colour 4000° K - 10W/m - IP65 <i>euro/m (euro/pack)</i> | 84118 |
| L5/NW/67NT | spool 5 m NT LED strip neutral white colour 4000° K - 10W/m - IP67 <i>euro/m (euro/pack)</i> | 84122 |
| AL/60/24 | power supply IP67 - PFC active - 24Vdc/60W <i>euro/pc</i> | 84150 |
| AL/90/24 | power supply IP67 - PFC active - 24Vdc/90W <i>euro/pc</i> | 84152 |
| AL/120/24 | power supply IP67 - PFC active - 24Vdc/120W <i>euro/pc</i> | 84154 |
| AL/150/24 | power supply IP67 - PFC active - 24Vdc/150W <i>euro/pc</i> | 84156 |
| DIMM/02 | dimmer/driver 24V/10 Amp - dim. mm 57x44x19 h. for white LED light <i>euro/pc</i> | 84187 |
| TEL/04 | 4- channel radio frequency remote control <i>euro/pc</i> | 84182 |
| RIC/01 | 4- remote control receiver radio frequency <i>euro/pc</i> | 84184 |
| TEL/RGB/04 | 4 channel radiofrequency remote control 433,92MHz for RGB LED diam. 80x13 h <i>euro/pc</i> | 84183 |



RIC/RGB/...



CE/5/20
CE/10/...



CE/RGB/20

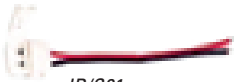

IR/C01

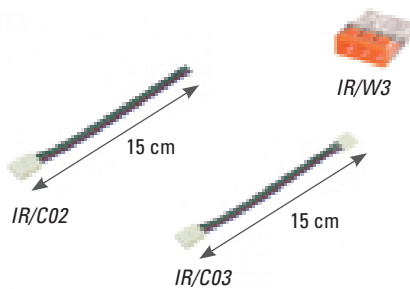

IR/W3

IR/C02

IR/C03

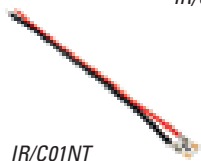

IR/C01NT



IR/C01NT

| | | |
|------------------|---|-------|
| RIC/RGB/M | master control unit with dimmer functiona/wireless for RGB LED diam. 174x46x35 h euro/pc | 84185 |
| RIC/RGB/S | slave control unit whit dimmer function for RGB LED (maximum 4 slave for each master) euro/pc | 84186 |
| CE/5/20 | electrical cable sect. 0,5 mm ² - pack 20 ml euro/m | 84420 |
| CE/10/20 | electrical cable sect. 1 mm ² - pack 20 ml euro/m | 84422 |
| CE/10/100 | electrical cable sect. 1 mm ² - pack 100 ml euro/m | 84424 |
| CE/RGB/20 | electrical cable for RGB LED section 3x0,5 mm ² + 1x1 mm ² - pack 20 m euro/m | 84426 |
| IR/C01 | rapid fit connector for strip LED white light - pack 10 pcs euro/pc | 84411 |
| IR/W3 | rapid fit connector 3 cables - pack 10 pcs euro/pc | 84410 |
| IR/C02 | rapid fit connector RGB LED strip - pack 10 pcs euro/pc | 84415 |
| IR/C03 | rapid fit double connector RGB LED strip - pack 10 pcs euro/pc | 84416 |
| IR/C01NT | rapid fit connector for NT LED strip white light - pack 10 pcs euro/pc (euro/pack) | 84413 |





entrance mats

Promat is a modular technical mat designed for both public and private use. Thanks to its easy assembly with a simple interlocking system, Promat does not need specific expertise and can be assembled directly on site. Promat is available in three insert solutions: carpet, brushes or rubber. In this way, it guarantees the cleaning and the protection of floors against dust, filth in general and water.

promat

Promat is a modular technical mat, which can be customized and created in any size directly on site, allowing maximum operational flexibility.

The installation of Promat is easy and quick thanks to the interlocking system with silver anodised aluminium profiles, already equipped with inserts in black carpet, rubber or brushes. The carpet insert, recommended for internal use, absorbs finer dirt and water, and also aids drying when passing through.

The rubber insert is resistant to atmospheric agents, making it ideal for outdoor use, removes coarse dirt and also has a non-slip function. Lastly, the brushes insert is suitable for outdoor installation in area of high pedestrian traffic thanks to its ability to remove the most difficult dirt.

Promat can be installed recessed or overlapped on existing floors according to the needs. In case of overlapping installation, there is the possibility to insert the ramp profile for facilitating the access.

Promat is also available in two already-assembled and ready-for-use versions in a choice of carpet or rubber/brush mix, in sizes 70x39,5 cm and 90x49,5 cm.



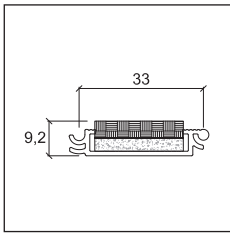

ZT/307/MN

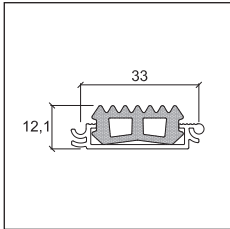

ZT/307/GN

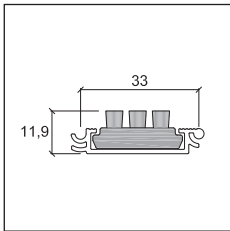

ZT/307/SN

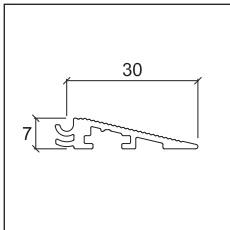

ZT/307/R1

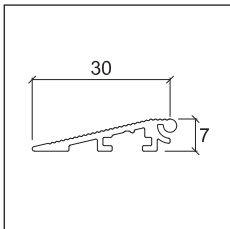

ZT/307/R2

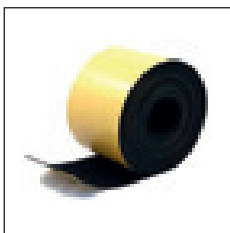

ZT/307/NA

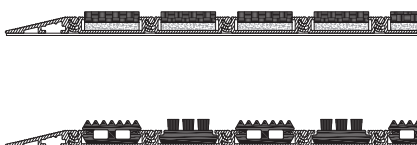

PROMAT

length = 270 cm - pack 10 pcs

| ART. | | | Conf. |
|-----------|--|-------|-------|
| ZT/307/MN | silver anodised aluminium profile + black carpet insert | 90400 | 10 |
| | <i>euro/m</i> | | |
| ZT/307/GN | silver anodised aluminium profile + black rubber insert | 90401 | 10 |
| | <i>euro/m</i> | | |
| ZT/307/SN | silver anodised aluminium profile + black brushes insert | 90402 | 10 |
| | <i>euro/m</i> | | |
| ZT/307/R1 | silver anodised aluminium right ramp profile | 90403 | 10 |
| | <i>euro/m</i> | | |
| ZT/307/R2 | silver anodised aluminium left ramp profile | 90404 | 10 |
| | <i>euro/m</i> | | |

individually packed

ACCESSORIES

length = 500 cm - pack 1 pc

| ART. | | | Conf. |
|-----------|---------------------------------|-------|-------|
| ZT/307/NA | adhesive tape in black EPDM 5 m | 90405 | 1 |
| | <i>euro/m (euro/rotolo)</i> | | |

no partial packaging

PROMAT - READY-MADE MAT

| ART. | | | Conf. |
|-----------|--|-------|-------|
| ZT/307/01 | ready-made mat dim. 70x39,5 cm with profiles with black carpet inserts | 90407 | 1 |
| | <i>euro/pc</i> | | |
| ZT/307/02 | ready-made mat dim. 70x39,5 cm with profiles with black rubber and brushes inserts | 90408 | 1 |
| | <i>euro/pc</i> | | |
| ZT/307/03 | ready-made mat dim. 90x49,5 cm with profiles with black carpet inserts | 90409 | 1 |
| | <i>euro/pc</i> | | |
| ZT/307/04 | ready-made mat dim. 90x49,5 cm with profiles with black rubber and brushes inserts | 90410 | 1 |
| | <i>euro/pc</i> | | |



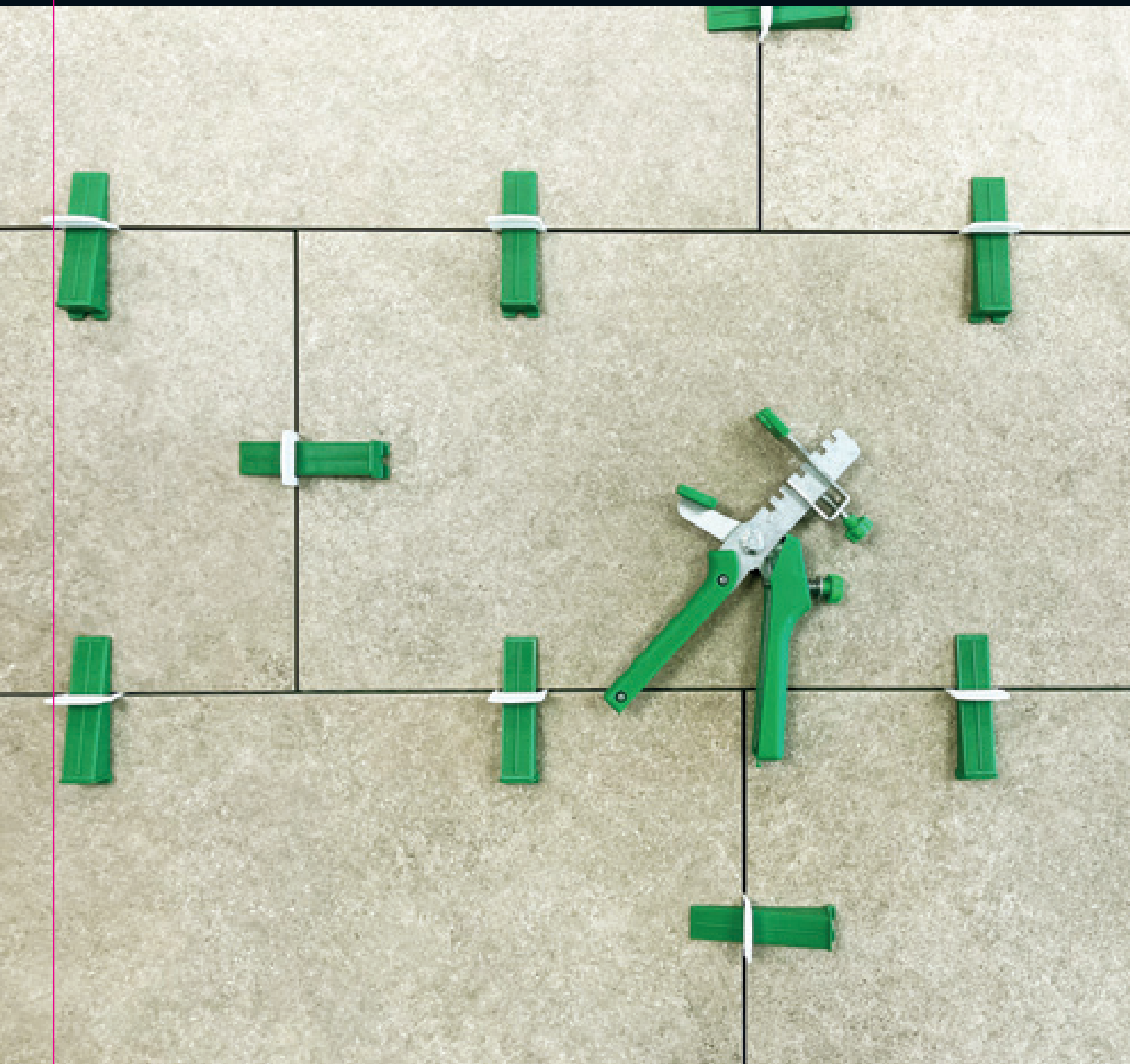

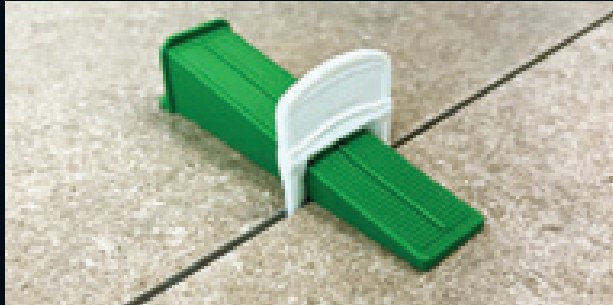

accessories for installation

Adhesives, utensils, systems
and accessories.

Protiler is a levelling system for the laying of ceramic and stone tiles. It is suitable for thicknesses from 3 to 20 mm and impedes the vertical movement between tiles during the adhesive grip phase. Specific pliers are available for the laying of floors and coverings for less effort and saving time.



Protiler



disposable clips installation



tiles laying

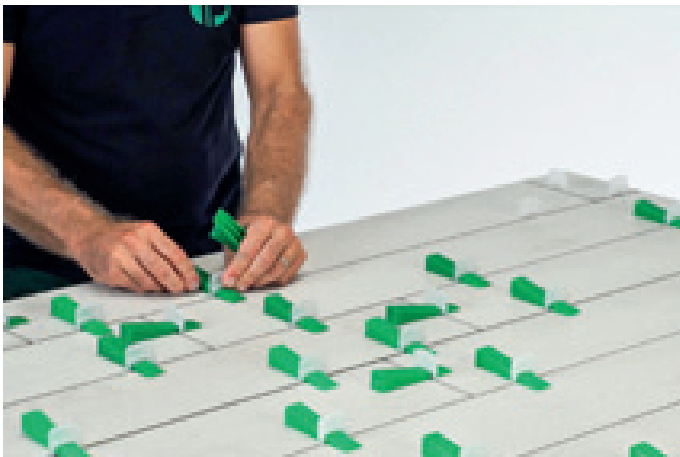

levelling wedges insertion



wedges and clips removal

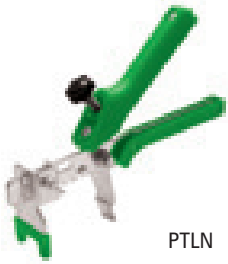

PTLN



PROTILER

pack 10 pcs

ART.

| | | |
|-------------|--|-------|
| PTLN | adjustable traction pliers <i>euro/pc (euro/pack)</i> | 18067 |
|-------------|--|-------|

no partial packaging

LEVELLING WEDGES

pack 14 bags with 100 pcs

pallet

ART.

| | | | |
|-------------|---|-------|----------|
| PTWN | levelling wedges <i>euro/pc (euro/bag)</i> | 18063 | 210 bags |
|-------------|---|-------|----------|

pack 1400 pcs

pallet

ART.

| | | | |
|------------------|--|-------|----------|
| PTWN/1400 | levelling wedges <i>euro/pc (euro/pack)</i> | 18076 | 15 packs |
|------------------|--|-------|----------|

no partial packaging



PTWN

DISPOSABLE CLIPS

pack 12 bags with 250 pcs

pallet

ART.

| | | | |
|------------|--|-------|----------|
| PTC | clips for 0,5 mm grouts and tile thicknesses from 3 to 12 <i>euro/pc (euro/bag)</i> | 18070 | 180 bags |
|------------|--|-------|----------|

| | | | |
|-------------|--|-------|----------|
| PTC1 | clips for 1 mm grouts and tile thicknesses from 3 to 12 <i>euro/pc (euro/bag)</i> | 18071 | 180 bags |
|-------------|--|-------|----------|

| | | | |
|--------------|--|-------|----------|
| PTC1A | clips for 1,5 mm grouts and tile thicknesses from 3 to 12 <i>euro/pc (euro/bag)</i> | 18075 | 180 bags |
|--------------|--|-------|----------|

| | | | |
|-------------|--|-------|----------|
| PTC2 | clips for 2 mm grouts and tile thicknesses from 3 to 12 <i>euro/pc (euro/bag)</i> | 18072 | 180 bags |
|-------------|--|-------|----------|

| | | | |
|-------------|--|-------|----------|
| PTC3 | clips for 3 mm grouts and tile thicknesses from 3 to 12 <i>euro/pc (euro/bag)</i> | 18073 | 180 bags |
|-------------|--|-------|----------|

pack 60 bags with 50 pcs

pallet

ART.

| | | | |
|---------------|--|-------|----------|
| PTC4/1 | clips for 1 mm grouts and tile thicknesses from 12 to 20 mm <i>euro/pc (euro/bag)</i> | 18082 | 600 bags |
|---------------|--|-------|----------|

| | | | |
|-------------|--|-------|----------|
| PTC4 | clips for 2 mm grouts and tile thicknesses from 12 to 20 mm <i>euro/pc (euro/bag)</i> | 18074 | 600 bags |
|-------------|--|-------|----------|

| | | | |
|---------------|--|-------|----------|
| PTC4/3 | clips for 3 mm grouts and tile thicknesses from 12 to 20 mm <i>euro/pc (euro/bag)</i> | 18084 | 600 bags |
|---------------|--|-------|----------|

| | | | |
|---------------|--|-------|----------|
| PTC4/5 | clips for 5 mm grouts and tile thicknesses from 12 to 20 mm <i>euro/pc (euro/bag)</i> | 18085 | 600 bags |
|---------------|--|-------|----------|

pack 3000 pcs

pallet

ART.

| | | | |
|-----------------|---|-------|----------|
| PTC/3000 | clips for 0,5 mm grouts and tile thicknesses from 3 to 12 <i>euro/pc (euro/pack)</i> | 18077 | 15 packs |
|-----------------|---|-------|----------|

| | | | |
|------------------|---|-------|----------|
| PTC1/3000 | clips for 1 mm grouts and tile thicknesses from 3 to 12 <i>euro/pc (euro/pack)</i> | 18078 | 15 packs |
|------------------|---|-------|----------|

| | | | |
|-------------------|---|-------|----------|
| PTC1A/3000 | clips for 1,5 mm grouts and tile thicknesses from 3 to 12 <i>euro/pc (euro/pack)</i> | 18079 | 15 packs |
|-------------------|---|-------|----------|

| | | | |
|------------------|---|-------|----------|
| PTC2/3000 | clips for 2 mm grouts and tile thicknesses from 3 to 12 <i>euro/pc (euro/pack)</i> | 18080 | 15 packs |
|------------------|---|-------|----------|

| | | | |
|------------------|---|-------|----------|
| PTC3/3000 | clips for 3 mm grouts and tile thicknesses from 3 to 12 <i>euro/pc (euro/pack)</i> | 18081 | 15 packs |
|------------------|---|-------|----------|

no partial packaging

BUCKET

pack 15 pcs

pack

ART.

| | | | |
|------------|--|-------|--------|
| PTS | 9.1 L bucket for accessories dim. cm 28x19x23 h. <i>euro/pc (euro/pack)</i> | 18069 | 15 pcs |
|------------|--|-------|--------|

no partial packaging



PTS



PTC
PTC 1
PTC1A
PTC2
PTC3



PTC4/1
PTC4
PTC4/3
PTC4/5

Fix Level is a screw levelling system for floors and coverings of different thickness, particularly suitable for large size tiles.

The cylinder incorporates a disk for the protection of the covering surface against scratches during the levelling phase.



Fix Level



FLM/C



FLM/S

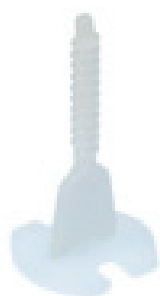

KLM/10

KLM/15

KLM/20

KLM/30

KLM/50

CYLINDER

pack 16 bags with 50 pcs

Pallet

ART.

| | | | |
|-------|---------------------------------------|-------|----------|
| FLM/C | cylinder <i>euro/pc (euro/bag)</i> | 18090 | 12 boxes |
|-------|---------------------------------------|-------|----------|

no partial packaging

ANTI-SCRATCH DISK

pack 35 bags with 50 pcs

ART.

| | | | |
|-------|--|-------|--|
| FLM/S | anti-scratch disk <i>euro/pc (euro/bag)</i> | 18091 | |
|-------|--|-------|--|

no partial packaging

DISPOSABLE SCREW SPACER

pack 25 bags with 100 pcs

Pallet

ART.

| | | | |
|--------|---|-------|----------|
| KLM/10 | screw for 1-mm grouts and tile thicknesses from 3 to 21 mm <i>euro/pc (euro/bag)</i> | 18093 | 12 boxes |
| KLM/15 | screw for 1,5-mm grouts and tile thicknesses from 3 to 21 mm <i>euro/pc (euro/bag)</i> | 18094 | 12 boxes |
| KLM/20 | screw for 2-mm grouts and tile thicknesses from 3 to 21 mm <i>euro/pc (euro/bag)</i> | 18095 | 12 boxes |
| KLM/30 | screw for 3-mm grouts and tile thicknesses from 3 to 21 mm <i>euro/pc (euro/bag)</i> | 18096 | 12 boxes |
| KLM/50 | screw for 5-mm grouts and tile thicknesses from 3 to 21 mm <i>euro/pc (euro/bag)</i> | 18097 | 12 boxes |

no partial packaging

DISPOSABLE T-SCREW SPACER

pack 25 bags with 100 pcs

Pallet

ART.

| | | | |
|---------|---|-------|----------|
| KLM/T10 | T-screw for 1-mm grouts and tile thicknesses from 3 to 21 mm <i>euro/pc (euro/bag)</i> | 18098 | 12 boxes |
| KLM/T15 | T-screw for 1,5-mm grouts and tile thicknesses from 3 to 21 mm <i>euro/pc (euro/bag)</i> | 18099 | 12 boxes |
| KLM/T20 | T-screw for 2-mm grouts and tile thicknesses from 3 to 21 mm <i>euro/pc (euro/bag)</i> | 18100 | 12 boxes |
| KLM/T30 | T-screw for 3-mm grouts and tile thicknesses from 3 to 21 mm <i>euro/pc (euro/bag)</i> | 18101 | 12 boxes |

no partial packaging

DISPOSABLE CROSS SCREW SPACER

pack 25 bags with 100 pcs

Pallet

ART.

| | | | |
|---------|---|-------|----------|
| KLM/X10 | cross screw for 1-mm grouts and tile thicknesses from 3 to 21 mm <i>euro/pc (euro/bag)</i> | 18102 | 12 boxes |
| KLM/X15 | cross screw for 1,5-mm grouts and tile thicknesses from 3 to 21 mm <i>euro/pc (euro/bag)</i> | 18103 | 12 boxes |
| KLM/X20 | cross screw for 2-mm grouts and tile thicknesses from 3 to 21 mm <i>euro/pc (euro/bag)</i> | 18104 | 12 boxes |
| KLM/X30 | cross screw for 3-mm grouts and tile thicknesses from 3 to 21 mm <i>euro/pc (euro/bag)</i> | 18105 | 12 boxes |

no partial packaging

Klic Level is a screw levelling system for floors and coverings of different thickness, particularly suitable for large size tiles. The cylinder incorporates a disk for the protection of the covering surface against scratches during the levelling phase, and a functional mechanism for a rapid insertion and expulsion of the disposable element.



Klic Level



KLM/C

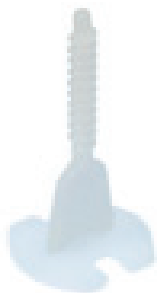

KLM/10
KLM/15
KLM/20
KLM/30
KLM/50

CYLINDER

pack 10 bags with 50 pcs

Pallet

ART.

| | | | |
|--------------|--|-------|----------|
| KLM/C | cylinder with anti-scratch disk <i>euro/pc (euro/bag)</i> | 18092 | 12 boxes |
|--------------|--|-------|----------|

no partial packaging

DISPOSABLE SCREW SPACER

pack 25 bags with 100 pcs

Pallet

ART.

| | | | |
|---------------|---|-------|----------|
| KLM/10 | screw for 1-mm grouts and tile thicknesses from 3 to 21 mm <i>euro/pc (euro/bag)</i> | 18093 | 12 boxes |
| KLM/15 | screw for 1,5-mm grouts and tile thicknesses from 3 to 21 mm <i>euro/pc (euro/bag)</i> | 18094 | 12 boxes |
| KLM/20 | screw for 2-mm grouts and tile thicknesses from 3 to 21 mm <i>euro/pc (euro/bag)</i> | 18095 | 12 boxes |
| KLM/30 | screw for 3-mm grouts and tile thicknesses from 3 to 21 mm <i>euro/pc (euro/bag)</i> | 18096 | 12 boxes |
| KLM/50 | screw for 5mm grouts and tile thicknesses from 3 to 21 mm <i>euro/pc (euro/bag)</i> | 18097 | 12 boxes |

no partial packaging

DISPOSABLE T-SCREW SPACER

pack 25 bags with 100 pcs

Pallet

ART.

| | | | |
|----------------|---|-------|----------|
| KLM/T10 | T-screw for 1-mm grouts and tile thicknesses from 3 to 21 mm <i>euro/pc (euro/bag)</i> | 18098 | 12 boxes |
| KLM/T15 | T-screw for 1,5-mm grouts and tile thicknesses from 3 to 21 mm <i>euro/pc (euro/bag)</i> | 18099 | 12 boxes |
| KLM/T20 | T-screw for 2-mm grouts and tile thicknesses from 3 to 21 mm <i>euro/pc (euro/bag)</i> | 18100 | 12 boxes |
| KLM/T30 | T-screw for 3-mm grouts and tile thicknesses from 3 to 21 mm <i>euro/pc (euro/bag)</i> | 18101 | 12 boxes |

no partial packaging

DISPOSABLE CROSS SCREW SPACER

pack 25 bags with 100 pcs

Pallet

ART.

| | | | |
|----------------|---|-------|----------|
| KLM/X10 | cross screw for 1-mm grouts and tile thicknesses from 3 to 21 mm <i>euro/pc (euro/bag)</i> | 18102 | 12 boxes |
| KLM/X15 | cross screw for 1,5-mm grouts and tile thicknesses from 3 to 21 mm <i>euro/pc (euro/bag)</i> | 18103 | 12 boxes |
| KLM/X20 | cross screw for 2-mm grouts and tile thicknesses from 3 to 21 mm <i>euro/pc (euro/bag)</i> | 18104 | 12 boxes |
| KLM/X30 | cross screw for 3-mm grouts and tile thicknesses from 3 to 21 mm <i>euro/pc (euro/bag)</i> | 18105 | 12 boxes |

no partial packaging

Plastic cross and T spacers used in the installation of floors and wall coverings for creating uniform and precise grout lines. They are available for thicknesses up to 10 mm and are suitable for both inside and outside spaces. Both spacers are compliant with UNI 11493-1 standard (methods for the correct installation of ceramic tiles).

Plastic wedges used for recovering small differences in height during tile installation.



Cross spacers

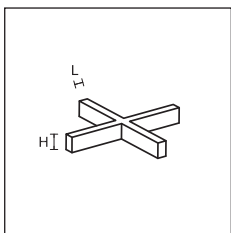

DC



CROSS SPACERS

| | box with 10 packs of 500 pcs | | | | | box with 20 packs of 250 pcs | |
|------------------|------------------------------|-----------|-------------|-------------|-------------|------------------------------|--------------|
| LxH | 1x5 | 2x5 | 3x5 | 4x5 | 5x5 | 7x6 | 10x8 |
| ART. | DC1 solid | DC2 solid | DC3 drilled | DC4 drilled | DC5 drilled | DC7 drilled | DC10 drilled |
| | 18992 | 19002 | 19008 | 19014 | 19020 | 19024 | 19030 |
| euro/pack | | | | | | | |

no partial packaging

T SPACERS

| | box with 10 packs of 500 pcs | | | | | box with 20 packs of 250 pcs | |
|------------------|------------------------------|-----------|-------------|-------------|-------------|------------------------------|--------------|
| LxH | 1x5 | 2x5 | 3x5 | 4x5 | 5x5 | 7x6 | 10x8 |
| ART. | DT1 solid | DT2 solid | DT3 drilled | DT4 drilled | DT5 drilled | DT7 drilled | DT10 drilled |
| | 19038 | 19042 | 19048 | 19054 | 19060 | 19064 | 19070 |
| euro/pack | | | | | | | |

no partial packaging

WEDGES

| pack | box with 20 packs of 250 pcs | box with 10 packs of 500 pcs |
|------------------|------------------------------|------------------------------|
| LxH | 9x28x5 | 9x28x5 |
| ART. | CN28 | CN28 |
| | 19080 | 19082 |
| euro/pack | | |

no partial packaging

CROSS SPACER FOR OUTDOOR USE

pack 2 bags with 50 pcs

| | | |
|------|--|-------|
| ART. | | |
| DCE4 | cross spacer for outdoor tiles and 4-mm grouts | 19076 |
| | euro/pc (euro/bag) | |

no partial packaging

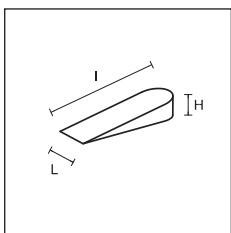

CN



DCE4



T Spacers



Wedges



skirting board adhesive

ADHESIVE

Cartridges 12 pcs - 300 ml (MS 45) and 290 ml (MS 55)

ART.

| | | | |
|-----------------------|-------|--------------------------|-----------|
| MAPEFLEX MS 45 | white | <input type="checkbox"/> | 6PB010043 |
| MAPEFLEX MS 55 | white | <input type="checkbox"/> | 6PV010043 |

For further information, please see Mapei price list.

MAGNETIC KIT

box with 10 blisters

| | |
|------------|-------|
| K10 | 00410 |
|------------|-------|

euro/blister



polishing paste

POLISHING PASTE FOR METAL PROFILE CLEANING

pack 20 pcs - quantity 150 ml

| | |
|------------------------|-------|
| POLISHING PASTE | 30018 |
|------------------------|-------|

euro/pc



doubled sided adhesive tapes

DOUBLED SIDED ADHESIVE TAPES

| | POLYPROPYLENE | COTTON CLOTH |
|----------------|---------------|--------------|
| pack | 24 | 24 |
| LxL cm | 5x2500 | 5x2500 |
| ART. | D/4461/K | D/4471/K |
| | 30004 | 30014 |
| <i>euro/pc</i> | | |



SCREWS

| | FLAT HEAD | | | | ROUND HEAD | |
|-----------------|---------------|--------------|---------------|--------------|---------------|--------------|
| box - 1000 pcs | | | | | | |
| finishing | nickel-plated | brass plated | bronze plated | brass plated | nickel-plated | brass plated |
| LxL mm | 3X25 | 3X25 | 3X25 | 3X25 | 3,5X25 | 3,5X25 |
| ART. | SS/5 | SS/5 | SS/5 | RR/5 | SS/4 | SS/4 |
| | 68800 | 68801 | 68802 | 68803 | 68804 | 68805 |
| <i>euro/box</i> | | | | | | |

proflex line

Proflex machine is a machine designed and built to model the profiles with curvilinear shape of the proflex line produced by Profilpas. The machine contains a proper kit and more kits are available in case you need to bend the PLAF or Metal Line 90.



PROFLEX MACHINE - hand machine to bend proflex line profiles



kit 30052

PROFLEX MACHINE

| ART. | description | |
|---------|--|-------|
| proflex | hand machine to bend profiles inside and outside | 30022 |
| | <i>euro/pc</i> | |
| 30052 | wheels kit for metal line flex 90/ | 30052 |
| | <i>euro/pc</i> | |

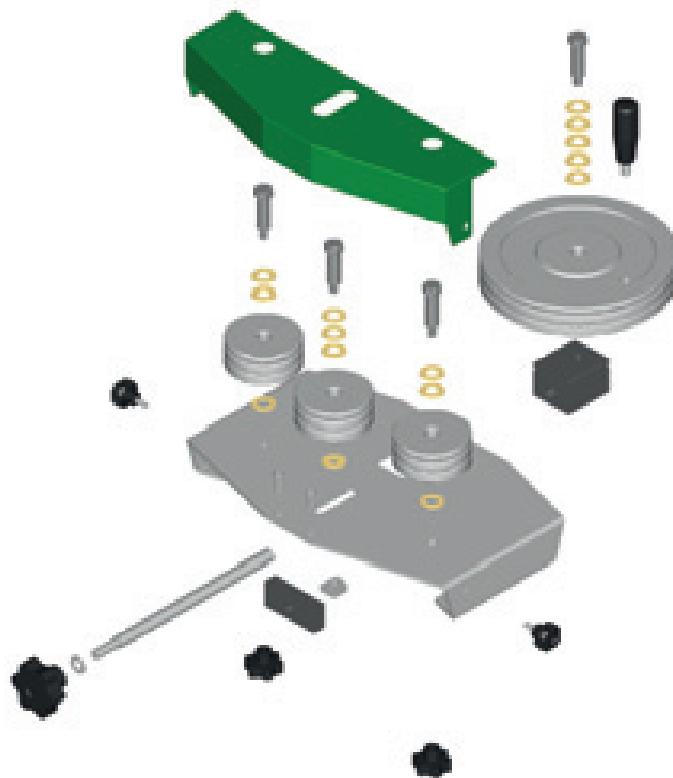

DIY profiles

A wide range of DIY profiles in aluminium, stainless steel and brass, available in many measures. Suitable to solve professional and bricolage works.





profiles in anodised aluminium

| | | with barcode label | | | | |
|------------------|--|--------------------|--------|-------------|--------|---------|
| | | length m. 1 | | length m. 2 | | |
| | | measures | silver | euro/pc | silver | euro/pc |
| flat | | 12x2 | 10100 | | 10104 | |
| | | 15x2 | 10108 | | 10112 | |
| | | 20x2 | 10116 | | 10120 | |
| | | 25x2 | 10124 | | 10128 | |
| | | 30x2 | 10132 | | 10136 | |
| | | 40x2 | - | - | - | - |
| | | 50x2 | - | - | - | - |
| | | 60x2 | - | - | - | - |
| corner | | 10x10x1 | 10140 | | 10144 | |
| | | 15x15x1 | 10148 | | 10152 | |
| | | 20x20x1* | 10156 | | 10160 | |
| | | 25x25x1* | 10164 | | 10168 | |
| | | 30x30x1* | 10172 | | 10176 | |
| | | 30x30x1,5 | - | - | 09020 | |
| | | 40x40x1,5 | 10380 | | 10384 | |
| | | 40x40x2 | - | - | - | - |
| | | 50x50x2 | - | - | - | - |
| corner L | | 15x10x1 | 10180 | | 10184 | |
| | | 20x10x1 | 10188 | | 10192 | |
| | | 30x15x1 | 10196 | | 10200 | |
| U profile | | 8x8x1 | 10204 | | 10208 | |
| | | 10x10x1 | 10212 | | 10216 | |
| | | 10x15x1 | 10220 | | 10224 | |
| | | 12x12x1 | - | - | 10218 | |
| double U profile | | 16x7x1 | - | - | 10232 | |
| | | 16x12x1 | 10236 | | 10240 | |
| | | 20x10x1 | - | - | 10248 | |
| | | 20x18x1 | 10252 | | 10256 | |
| edge trim | | 18x1 | 10260 | | 10264 | |
| | | 22x1 | 10268 | | 10272 | |
| | | 25x1 | 10276 | | 10280 | |
| round tube | | 8x1 | 09032 | | 09036 | |
| | | 10x1 | 09040 | | 09044 | |
| | | 12x1 | 09048 | | 09052 | |
| | | 15x1 | 10284 | | 10288 | |
| | | 18x1 | 10292 | | 10296 | |
| | | 20x1 | 10300 | | 10304 | |
| | | 25x1,5 | - | - | 09060 | |
| square tube | | 10x10x1 | 10308 | | 10312 | |
| | | 15x15x1 | 10316 | | 10320 | |
| | | 20x20x1 | 10324 | | 10328 | |
| rectangular tube | | 20x10x1 | 10332 | | 10336 | |
| | | 30x15x1 | 10340 | | 10344 | |
| T profile | | 15x15x1,5 | 10348 | | 10352 | |
| | | 25x25x1,5 | 10356 | | 10360 | |
| round bar | | Ø 6 | - | - | 09084 | |
| | | Ø 8 | 10364 | | 10368 | |
| | | Ø 10 | - | - | 09092 | |
| square bar | | 8x8 | 10372 | | 10376 | |
| | | 10x10 | - | - | 10394 | |

Articles no partial packaging. Pack. 10 pcs per item - Minimum order : 100 assorted pcs DIY range.

* items available also 3 m long without barcode pag 253

EAN 13 = the first group product code

example code 10395 = 8010937 10395



profiles in anodised aluminium

| | | without barcode label | | | | |
|------------------|--------|-----------------------|---------|-------------|---------|--|
| | | length m. 2 | | length m. 3 | | |
| | | silver | euro/pc | silver | euro/pc | |
| flat | | measures | | | | |
| | | 12x2 | 510104 | - | - | |
| | | 15x2 | 510112 | - | - | |
| | | 20x2 | 510120 | - | - | |
| | | 25x2 | 510128 | - | - | |
| | | 30x2 | 510136 | - | - | |
| | | 40x2 | 510095 | 510096 | | |
| | | 50x2 | 510099 | 510097 | | |
| 60x2 | 510100 | 510098 | | | | |
| corner | | 10x10x1 | 510144 | - | - | |
| | | 15x15x1 | 510152 | - | - | |
| | | 20x20x1 | 510160 | 510158 | | |
| | | 25x25x1 | 510168 | 510166 | | |
| | | 30x30x1 | 510176 | 510174 | | |
| | | 30x30x1,5 | 509020 | - | - | |
| | | 40x40x1,5 | 510384 | - | - | |
| | | 40x40x2 | 510381 | 510383 | | |
| | | 50x50x2 | 510382 | 510387 | | |
| | | corner L | | 15x10x1 | 510184 | |
| 20x10x1 | 510192 | | | | | |
| 30x15x1 | 510200 | | | | | |
| U profile | | 8x8x1 | 510208 | | | |
| | | 10x10x1 | 510216 | | | |
| | | 10x15x1 | 510224 | | | |
| | | 12x12x1 | 510218 | | | |
| double U profile | | 16x7x1 | 510232 | | | |
| | | 16x12x1 | 510240 | | | |
| | | 20x10x1 | 510248 | | | |
| | | 20x18x1 | 510256 | | | |
| edge trim | | 18x1 | 510264 | | | |
| | | 22x1 | 510272 | | | |
| | | 25x1 | 510280 | | | |
| round tube | | 8x1 | 509036 | | | |
| | | 10x1 | 509044 | | | |
| | | 12x1 | 509052 | | | |
| | | 15x1 | 510288 | | | |
| | | 18x1 | 510296 | | | |
| | | 20x1 | 510304 | | | |
| 25x1,5 | 509060 | | | | | |
| square tube | | 10x10x1 | 510312 | | | |
| | | 15x15x1 | 510320 | | | |
| | | 20x20x1 | 510328 | | | |
| rectangular tube | | 20x10x1 | 510336 | | | |
| | | 30x15x1 | 510344 | | | |
| T profile | | 15x15x1,5 | 510352 | | | |
| | | 25x25x1,5 | 510360 | | | |
| round bar | | Ø 6 | 509084 | | | |
| | | Ø 8 | 510368 | | | |
| | | Ø 10 | 509092 | | | |
| square bar | | 8x8 | 510376 | | | |
| | | 10x10 | 510394 | | | |

Articles no partial packaging. Pack. 10 pcs per item - Minimum order : 100 assorted pcs DIY range.







EAN 13 = the first group product code

example code 10395 = 8010937 10395

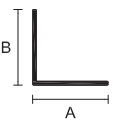
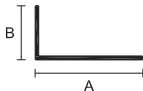
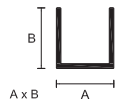

profiles in anodised and colour-coated aluminium

with barcode label
length m. 2

| | measures | gold anodised | titanium anodised | colour-coated white RAL 9003 | <i>euro/pc</i> |
|------------------|---|------------------|-------------------|------------------------------|----------------|
| flat |  | 12x2 | 10105 | - | - |
| | | 15x2 | 10113 | - | 11612 |
| | | 20x2 | 10121 | 10470 | 11620 |
| | | 30x2 | 10137 | - | 11636 |
| corner |  | 10x10x1 | 10145 | 10452 | 11644 |
| | | 15x15x1 | 10153 | 10454 | 11652 |
| | | 20x20x1 | 10161 | 10456 | 11660 |
| | | 25x25x1 | 10169 | 10458 | 11668 |
| | | 30x30x1 | 10177 | - | 11676 |
| | | 40x40x1,5 | 10385 | - | 11684 |
| corner L |  | 15x10x1 | 10185 | 10462 | 11692 |
| | | 20x10x1 | 10193 | 10464 | 11700 |
| | | 30x15x1 | 10201 | 10466 | 11708 |
| U profile |  | 8x8x1 | 10209 | - | - |
| | | 10x10x1 | - | - | 11724 |
| | | 10x15x1 | 10225 | - | - |
| double U profile |  | 20x18x1 | - | - | 11764 |
| edge trim |  | 18x1 | 10265 | - | 11772 |
| | | 22x1 | 10273 | - | - |
| | | 25x1 | 10281 | - | - |
| round tube |  | 10x1 | 09045 | - | - |
| | | 15x1 | - | - | 11796 |
| | | 18x1 | 10297 | - | - |
| | | 20x1 | 10305 | - | - |
| square tube |  | 10x10x1 | - | - | 11820 |
| rectangular tube |  | 20x10x1 | 10337 | - | 11844 |
| T profile |  | 15x15x1,5 | - | - | 11860 |
| | | 25x25x1,5 | - | - | 11868 |

Articles no partial packaging. Pack. 10 pcs for gold items, 5 pcs for titanium items



Minimum order: 100 assorted pcs DIY range.

EAN 13 = the first group product code

example code 10395 = 8010937 10395

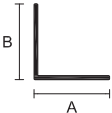
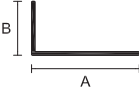
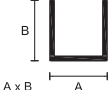

profiles in bright polished silver aluminium

| | | with barcode label | | | |
|--|-----------|--------------------|---------|-------------|---------|
| | | length m. 1 | | length m. 2 | |
| | measures | silver | euro/pc | silver | euro/pc |
| flat  | 15x2 | - | - | 10115 | |
| | 20x2 | - | - | 10123 | |
| | 25x2 | - | - | 10131 | |
| corner  | 10x10x1 | 10143 | | 10147 | |
| | 15x15x1 | 10151 | | 10155 | |
| | 20x20x1 | 10159 | | 10163 | |
| | 25x25x1 | - | - | 10171 | |
| | 30x30x1 | - | - | 10179 | |
| corner L  | 15x10x1 | - | - | 10186 | |
| | 20x10x1 | - | - | 10195 | |
| | 30x15x1 | - | - | 10203 | |
| U profile  | 10x10x1 | - | - | 10219 | |
| | 10x15x1 | - | - | 10227 | |
| | 12x12x1 | - | - | 10211 | |
| edge trim  | 18x1 | - | - | 10267 | |
| T profile  | 15x15x1,5 | 10351 | | 10355 | |

Pack. 5 pcs per article

Minimum order: 100 assorted pcs DIY range.



polished brass and stainless steel corners

with barcode label

length m. 2

| corner | measures | polished brass | | stainless steel | |
|--------|----------------|----------------|---------|-----------------|---------|
| | | cod. | euro/pc | cod. | euro/pc |
| | 15x15x1 | 10002 | - | 10050 | - |
| | 20x20x1 | 10006 | - | 10054 | - |
| | 25x25x1 | - | - | 10058 | - |
| | 30x30x1 | 10014 | - | 10062 | - |
| | 40x40x1 | - | - | 10070 | - |
| | 15x10x1 | 10030 | - | - | - |
| | 20x10x1 | 10034 | - | 10082 | - |
| | 30x10x1 | - | - | 10086 | - |

Articles no partial packaging.

Pack. 5 pcs per article - Minimum order: 100 assorted pcs DIY range.

EAN 13 = the first group product code

example code 10094 = 8010937 10094

curtain counterweights in silver anodised aluminium with rounded edges

| | measures | length m. 1 | | length m. 2 | | length m. 4 | |
|--|-----------------------------|-------------|---------|-------------|---------|-------------|---------|
| | | cod. | euro/pc | cod. | euro/pc | cod. | euro/pc |
| | 30x4 boxes pcs 10 | 10604 | - | 10605 | - | 10606 | - |
| | 40x4 boxes pcs 10 | 10608 | - | 10609 | - | - | - |

Articles no partial packaging.

EAN 13 = the first group product code

example code 10824 = 8010937 10824

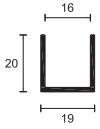
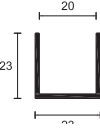
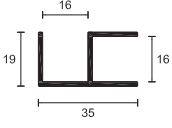
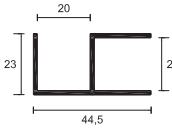
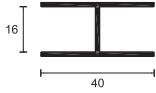

silver anodised aluminium profiles for structures

| | | | | with barcode label | | | | | |
|------------------|---|---|----|--------------------|-----------|-------------|---------|------|---------|
| | | | | length m. 2 | | length m. 3 | | | |
| | | | | measures | thickness | cod. | euro/pc | cod. | euro/pc |
| U profile |  | for panels frame thickness up to 16 mm Packaging 6 pcs per item. | 16 | 1,5 | 10500 | | 10504 | | |
| U profile |  | for panels frame thickness up to 20 mm Packaging 6 pcs per item. | 20 | 1,5 | 10532 | | 10536 | | |
| double U profile |  | for 90° corners between panel boards thickness up to 16 mm Packaging 6 pcs per item. | 16 | 1,5 | - | - | 10512 | | |
| double U profile |  | for 90° corners between panel boards thickness up to 20 mm Packaging 6 pcs per item. | 20 | 1,5 | - | - | 10544 | | |
| H profile |  | for connection of panels thickness up to 16 mm Packaging 6 pcs per item. | 16 | 1,5 | - | - | 10520 | | |



Design is our best profile.

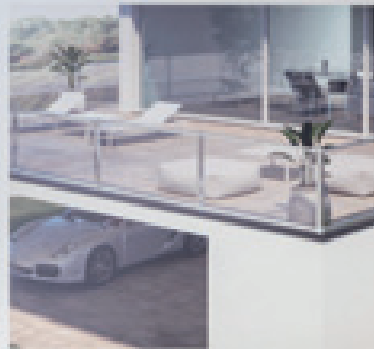

Design is our best profile.





Design is our best profile.

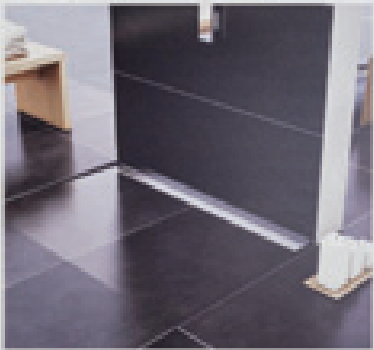

Design is our best profile.



merchandising for the point of sale

A series of tools dedicated to the showroom: modular expositive pieces of furniture, counter display boxes, sampleboards, sample boxes, cylinders etc for creating suitable areas for every need of space and products.



Profilpas concept store: a modular display system composed of panels that can be used singularly or combined together. For each panel, there is the possibility to choose the display units according to the products treated.



self-supporting base for panels

| | |
|--|---------|
| PANEL 1 terrace picture DIM. CM 90X220 H. | 02036 € |
| PANEL 2 living room picture DIM. CM 90X220 H. | 02037 € |
| PANEL 3 bathroom picture DIM. CM 90X220 H. | 02038 € |
| PANEL 4 staircase picture DIM. CM 90X220 H. | 02039 € |
| PANNELLO 5 pp drain aqua bathroom picture DIM. CM 90X220 H. | 02080 € |
| SELF-SUPPORTING BASE FOR PANELS | 02040 € |
| DISPLAY UNIT 1 - CPGV+CPQV+MAPEGUARD UM 35 | 02041 € |
| DISPLAY UNIT 2 - CPNV+CPCV/30 | 02042 € |
| DISPLAY UNIT 3 - SNG+SIR+SIG+SIS+SP+76 | 02043 € |
| DISPLAY UNIT 4 - GIN+ILN+ZQIN | 02044 € |
| DISPLAY UNIT 5 - ZQVN Trend Color Stone | 02045 € |
| DISPLAY UNIT 6 - SLIM DRAIN+GLASS PROFILE | 02046 € |
| DISPLAY UNIT 7 - SMART DRAIN | 02047 € |
| DISPLAY UNIT 8 - THIN DRAIN | 02048 € |
| DISPLAY UNIT 9 - case for sample boards (without sample boards) | 02049 € |
| DISPLAY UNIT 10 - 8605+8608 | 02055 € |
| DISPLAY UNIT 11 - PP LEVEL DUO MAXI | 02064 € |
| DISPLAY UNIT 7/a - shelf only | 02056 € |
| DISPLAY 12 - PP DRAIN AQUA CLASSIC BRUSHED STEEL + GLASS PROFILE BRUSHED STEEL | 02067 € |
| DISPLAY 13 - PP DRAIN AQUA FLAT BLACK ALUMINIUM + GLASS PROFILE BRUSHED STEEL | 02068 € |
| DISPLAY 14 - SHELF FOR 2 FLAT COVER AND 1 DESIGN COVER OF YOUR CHOICE (covers not included to be ordered separately) | 02069 € |
| DISPLAY 15 - SHELF FOR 3 FLAT COVER OF YOUR CHOICE (covers not included to be ordered separately) | 02070 € |
| DISPLAY 16 - Q DRAIN CLASSIC POLISHED STEEL + TILE | 02071 € |

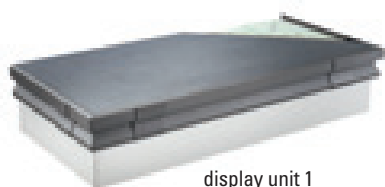

display unit 1
CPGV + CPQV + UM 35

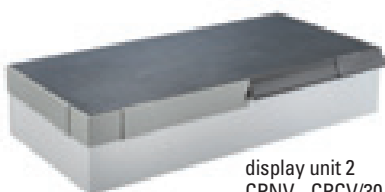

display unit 2
CPNV - CPCV/30



display unit 3
SNG + SIR + SGI +
SIS + SP - 76

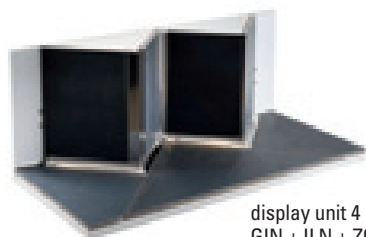

display unit 4
GIN + ILN + ZQIN

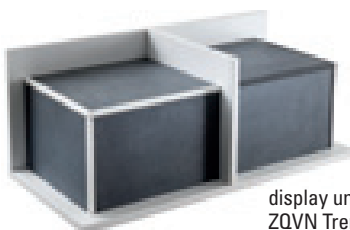

display unit 5
ZQVN Trend
Color Stone

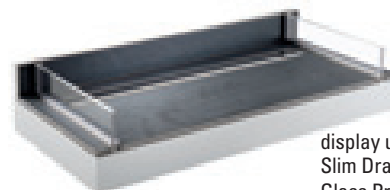

display unit 6
Slim Drain +
Glass Profile



display unit 7
Smart Drain



display unit 8
Thin Drain



display unit 9
case for sample boards



display unit 10
8605 - 8608



display unit 11
PP level DUO MAXI



display unit 7/A
shelf only



display unit 12
PP Drain Aqua Classic Cover + Glass Profile



display unit 13
PP Drain Aqua Flat Cover + Glass Profile



display unit 14
Flat Cover + Design Cover

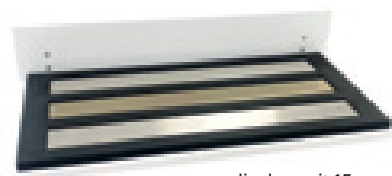

display unit 15
Flat Cover



display unit 16
Q Drain Classic + Tile



| | | |
|--|-------|---|
| black totem for sample boards dim. cm 55x55x200 h | 02034 | € |
| white totem for sample boards dim. cm 55x55x200 h. | 02035 | € |



| | | |
|-------------------------------------|-------|---|
| counter display for 4 sample boards | 00273 | € |
|-------------------------------------|-------|---|



Exhibition panels divided for different application categories.
They are also suitable for inclusion in the drawer corner shop.

| | | | |
|------------------|---|-------|---|
| sampleboard 1 | PROLIST decorative listellos and profiles | 02015 | € |
| sampleboard 2 | external corners profiles PROTRIM | 02016 | € |
| sampleboard 3 | external corners profiles PROANGLE Q | 02017 | € |
| sampleboard 4 | external corners profiles PROCORNER internal corners profiles PROROUND | 02018 | € |
| sampleboard 5 | profiles for small gaps | 02019 | € |
| sampleboard 6 | profiles for floors of same height | 02020 | € |
| sampleboard 7 | profiles for floors of different height | 02021 | € |
| sampleboard 8 | profiles for LVT floors | 02022 | € |
| sampleboard 9 | Expansion joints PROJOINT | 02023 | € |
| sampleboard 10 | profiles for balconies and terraces PROTEC | 02024 | € |
| sampleboard 11 | stair nosing profiles | 02025 | € |
| sampleboard 12/A | Unisystem plus | 02065 | € |
| sampleboard 12/B | prestowood - pvc line | 02066 | € |
| sampleboard 13/A | METAL LINE 89-90-790 | 02057 | € |
| sampleboard 13/B | METAL LINE 87-88-92-93-95-97-98-100 | 02058 | € |
| sampleboard 14 | Trend Color | 02028 | € |
| sampleboard 17 | PVC Line skirting boards | 02078 | € |







| | | |
|--|-------|---|
| black counter display Trend Color Proangle Q | 00193 | € |
| black counter display Trend Color Proangle | 00219 | € |
| black counter display Proangle Q | 00166 | € |

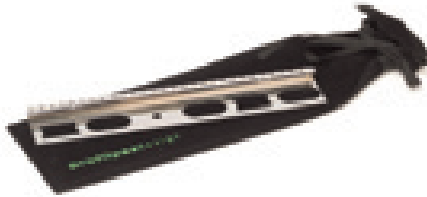

| | | |
|------------------------------|-------|---|
| cylinder wall profiles | 00103 | € |
| cylinder floor profiles | 00104 | € |
| cylinder small gaps profiles | 00114 | € |
| cylinder proangle Q | 00115 | € |
| cylinder unisystem | 00080 | € |
| cylinder proline | 00127 | € |
| cylinder LVT | 00142 | € |
| cylinder proligh | 00143 | € |



| | | | |
|---|-----------------|-------|---|
|  | sample DJKC/10 | 00134 | € |
|  | sample DJKC/10 | 00135 | € |
|  | sample UKC/10 | 00136 | € |
|  | sample DJKGC/10 | 00137 | € |
|  | sample UKGC/10 | 00138 | € |



| | | |
|----------------------------|-------|---|
| brochure trend color IT/EN | 00282 | € |
| brochure trend color FR/DE | 00283 | € |
| brochure trend color ES/PT | 00284 | € |



| | | |
|---|-------|---|
| brochure profiles and skirting boards for wood and laminate IT/GB | 00285 | € |
| brochure profiles and skirting boards for wood and laminate FR/DE | 00286 | € |
| brochure profiles and skirting boards for wood and laminate ES/PT | 00287 | € |
| brochure profiles and skirting boards for wood and laminate CZ/PL | 00290 | € |



| | | |
|--|-------|---|
| brochure profiles for balconies and terraces IT/GB | 00279 | € |
| brochure profiles for balconies and terraces FR/DE | 00280 | € |
| brochure profiles for balconies and terraces ES/PT | 00281 | € |
| brochure profiles for balconies and terraces CZ/PL | 00288 | € |



| | | |
|-----------------------|-------|------|
| brochure promat IT/EN | 00305 | €/pz |
| brochure promat FR/DE | 00319 | €/pz |
| brochure promat ES/PT | 00321 | €/pz |
| brochure promat CZ/PL | 00323 | €/pz |

| | | |
|-------------------|-------|---|
| sample box PROMAT | 00349 | € |
|-------------------|-------|---|

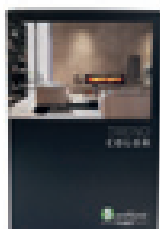

| | | |
|------------------------|-------|---|
| sample box PROANGLE Q | 00351 | € |
| sample box TREND COLOR | 00353 | € |

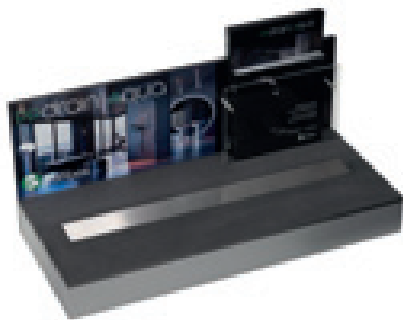

| | | |
|--|-------|---|
| counter display pp drain aqua - classic cover dim. cm 70x32x30 H. (60 cm cover not included, to be ordered separately) | 02072 | € |
| counter display pp drain aqua - flat cover or invisible cover dim. cm 70x32x30 H. (60 cm cover not included, to be ordered separately) | 02073 | € |
| counter display pp drain aqua - design cover dim. cm 70x32x30 H. (60 cm cover not included, to be ordered separately) | 02074 | € |

| | | |
|---|-------|---|
| counter display pp drain aqua - classic cover dim. cm 70x32x30 H. (60 cm linear drain and cover not included, to be ordered separately) | 02075 | € |
|---|-------|---|

| | | |
|---|-------|---|
| counter display pp drain aqua - flat cover or invisible cover dim. cm 70x32x30 H. (60 cm linear drain and cover not included, to be ordered separately) | 02076 | € |
|---|-------|---|

| | | |
|--|-------|---|
| counter display pp drain aqua - design cover dim. cm 70x32x30 H. (60 cm linear drain and cover not included, to be ordered separately) | 02077 | € |
|--|-------|---|



| | | |
|---------------------------|-------|---|
| sample case PP Drain AQUA | 02079 | € |
|---------------------------|-------|---|



| | | |
|------------------------------|-------|---|
| brochure pp drain aqua IT/GB | 00295 | € |
|------------------------------|-------|---|

| | | |
|------------------------------|-------|---|
| brochure pp drain aqua FR/DE | 00296 | € |
|------------------------------|-------|---|

| | | |
|------------------------------|-------|---|
| brochure pp drain aqua ES/PT | 00297 | € |
|------------------------------|-------|---|

| | | |
|------------------------------|-------|---|
| brochure pp drain aqua CZ/PL | 00298 | € |
|------------------------------|-------|---|



| | | |
|--|-------|---|
| sample of glass profile in brushed stainless steel | 00072 | € |
|--|-------|---|

| | | |
|---|-------|---|
| sample of glass profile in matt black colour-coated stainless steel | 00078 | € |
|---|-------|---|

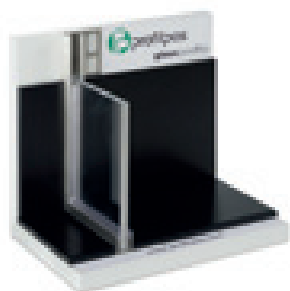

| | | |
|---|-------|---|
| counter display glass profile - brushed stainless steel | 00311 | € |
|---|-------|---|

| | | |
|--|-------|---|
| counter display glass profile - matt black colour-coated stainless steel | 00315 | € |
|--|-------|---|



PDS bunch

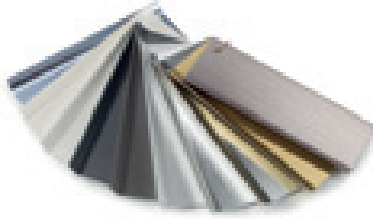

metal line bunch



bunch 8605/8608



pvc skirting board bunch



bunch ZQP



bunch RPA



profiles for balconies bunch



bunch RE



bunch REC



bunch RECO



DIY bunch



sandblast stainless steel bunch



chromium-plated brass bunch



antibacterial profiles bunch

| | | |
|--|-------|---|
| PDS bunch | 00020 | € |
| metal line bunch | 00119 | € |
| PVC skirting board bunch | 00085 | € |
| profiles for balconies bunch | 00117 | € |
| ZQP bunch | 00027 | € |
| RPA bunch | 00050 | € |
| RE bunch | 00011 | € |
| REC bunch | 00049 | € |
| RECO bunch | 00133 | € |
| DIY bunch | 00128 | € |
| chromium-plated brass bunch | 00130 | € |
| sandblast stainless steel profiles bunch | 00132 | € |
| bunch pvc stair nosing | 00084 | € |
| bunch antibacterial profiles | 00147 | € |
| bunch PDS xl | 00140 | € |
| bunch black & white | 00033 | € |
| bunch ZV Trend Color | 00023 | € |
| bunch IPV Trend Color Stone | 00037 | € |
| bunch Prestowood | 00039 | € |
| bunch PVC LINE 8181 | 00018 | € |
| mix bunch (GHF) | 00146 | € |



| | | |
|--|-------|---|
| ES/7 polished white + 11 dividers | 11594 | € |
| ES/7 black + 11 dividers | 11596 | € |
| Dimensions: width cm 96 - depth cm 50 - height cm 270 | | |
| Rack display stand for profiles and skirting boards up to 270 cm long. | | |
| 11 width-adjustable dividers. | | |
| ACCESSORIES: | | |
| A) DIVIDER - polished white | 11597 | € |
| DIVIDER - black | 11598 | € |
| B) LATERAL GRILL - polished white | 11519 | € |
| LATERAL GRILL - black | 11521 | € |
| For attaching trays and/or hooks for accessories. | | |
| C) Set of 4 TRAYS for lateral grill - polished white | 11528 | € |
| Set of 4 TRAYS for lateral grill - black | 11531 | € |
| D) Set of 10 HOOKS for lateral grill - polished white | 11534 | € |
| Set of 10 HOOKS for lateral grill - black | 11535 | € |
| DISPLAY STAND BOARDS: | | |
| board about profiles for ceramic tiles | 11522 | € |
| board about profiles for wood, laminate, LVT | 11532 | € |

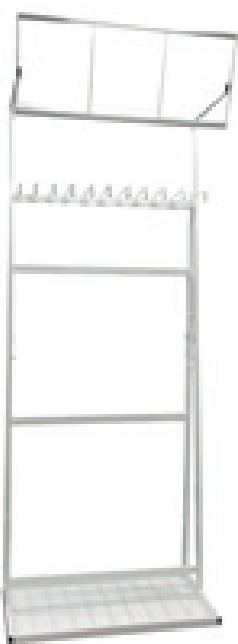

ES/7 polished white + 11 dividers



polished white divider



polished white lateral grill for attaching trays and/or hooks for accessories



polished white tray for lateral grill



polished white hooks for lateral grill

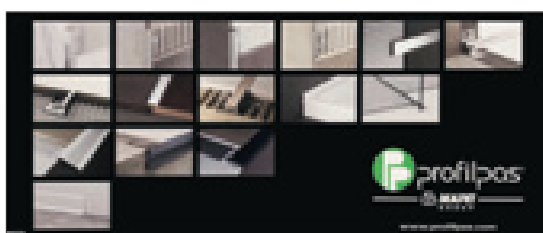

board about profiles for ceramic tiles

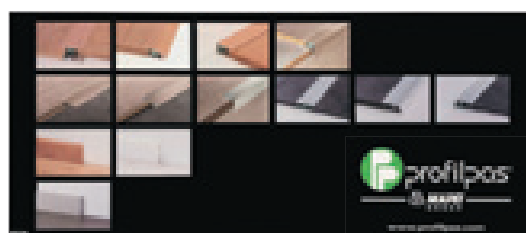

board about profiles for wood, laminate, LVT



ES/6

11506 €

dimensions: width cm 96 - depth cm 28 - height cm 94

MATERIALS AND CHARACTERISTICS

The following information summarize the main characteristics of the materials. Further information are available upon request of the product specifications.

NATURAL BRASS

Alloy CW624N UNI EN 12167 The profiles are produced by extrusion. They have a good resistance to chemical agents and mechanical stresses. On the visible parts the brass naturally oxidizes that creates a superficial glaze. The brass, when exposed to corrosive agents or high humidity, is subject to phenomena of high oxidation and can present superficial spots. Where necessary, it can be restored to its original state by using abrasives or specific polishing products.

POLISHED BRASS

Alloy CW624N UNI EN 12167 The profiles are produced by extrusion and then mechanically polished. The visible surface must be protected from scratches and frictions. The resistance to chemical agents and mechanical stresses is good. On the visible parts the brass naturally oxidizes that creates a superficial glaze. The brass, when exposed to corrosive agents or high humidity, is subject to phenomena of high oxidation and can present superficial spots. Where necessary, it can be restored to its original state by using abrasives or specific polishing products.

CHROMIUM - PLATED BRASS

Alloy CW624N UNI EN 12167 The profiles are produced by extrusion and then chromed. They are resistant to ultraviolet rays, weathering and chemical agents. They are not suitable for applications in floors with intense mechanical stresses.

NATURAL ALUMINIUM

Alloy of Al-Mg-Si thermally treated in conditions T6 (6060 T6) The profiles are produced by extrusion and guarantee a fair resistance to atmospheric and chemical agents. The cement and its derivatives produce, if wet, alkaline substances that, acting on the surface, can corrode the metal (formation of hydroxide of aluminium). For that reason, the visible surface of the profile must be immediately cleaned from cement, glue and other materials used for joints.

ANODISED ALUMINIUM

Alloy of Al-Mg-Si thermally treated in conditions T6 (6060 T6) The profiles are produced by extrusion and then anodised. They have a good resistance to atmospheric and chemical agents. The cement and its derivatives produce, if wet, alkaline substances that, acting on the surface, can corrode the metal (formation of hydroxide of aluminium). For that reason, the visible surface of the profile must be immediately and gently cleaned from cement, glue and other materials used for joints. Wear and pedestrian traffic could damage the surface (in cases of profiles laid on the floor) and remove the original anodised finish.

POLISHED ALUMINIUM

Alloy of Al-Mg-Si thermally treated in conditions T6 (6463 T6) The profiles are produced by extrusion and then mechanically treated and processed. They guarantee a fair resistance to atmospheric and chemical agents. The cement and its derivatives produce, if wet, alkaline substances that, acting on the surface, can corrode the metal (formation of hydroxide of aluminium). For that reason, the visible surface of the profile must be immediately and gently cleaned from cement, glue and other materials used for joints. Polished aluminium profiles are not suitable for floor applications.

COLOUR - COATED ALUMINIUM

Alloy of Al-Mg-Si thermally treated in conditions T6 (6060 T6) The profiles are made by extrusion and then coated with a thickness of $\geq 80 \mu\text{m}$. They have

a fair resistance to atmospheric and chemical agents while they do not have a good resistance to mechanical stresses that would damage the surface enamel; therefore they are not recommended for floor applications. For that reason, the visible surface of the profile must be immediately and gently cleaned from cement, glue and other materials used for joints.

ALCROM® PLUS FOILED ALUMINIUM

Alloy of Al-Mg-Si thermally treated in conditions T6 (6060 T6) The profiles are produced by extrusion in natural alloy. The wood decoration is obtained by foiling the aluminium profiles with a special film Alcrom® Plus, resistant to wear, perfectly reproducing grains and colours of wood.

STAINLESS STEEL - AISI 430 - DIN 1.4016

This kind of stainless steel has a moderate resistance to corrosive agents. We recommend its use exclusively for indoor use.

STAINLESS STEEL - AISI 304 - DIN 1.4301 V2A

It is extremely resistant to most chemical and atmospheric agents, lime, mortar, tile glue and common cleaning products. It is recommended for outdoor use, food processing industry, hospitals, etc.

STAINLESS STEEL - AISI 316 – DIN 1.4404 V4A

It is extremely resistant to most chemical and atmospheric agents, lime, mortar, tile glue and common cleaning products. Moreover it has a good resistance to chlorine and salt. Particularly indicated in extreme conditions of use.

COLOUR-COATED STAINLESS STEEL - AISI 304 - DIN 1.4301

The profiles are made of brushed stainless steel and then coated with a thickness of $\geq 80 \mu\text{m}$. They present a relatively good resistance to chemical and atmospheric agents but not to mechanical stress which damages the surface coating. Concrete, adhesive, grouting materials and detergents must be immediately removed from the visible surface of the profile.

LAYING - WARNINGS:

even stainless steel can be damaged if not treated with proper precautions during the laying stages. In particular, pay attention to: keeping the profiles protected inside their individual packaging up until the installation. (this precaution allows to avoid the contamination with other ferrous materials during the transport). Avoiding the direct contact with cleaning products for cotto tiles and marble, decalcifying agents and cleansers containing chlorine and its compounds. Pay attention to the gases of hydrochloric acid which may develop during the cleansing of special floors. After the laying, proceed immediately with an accurate cleaning of the surface with plenty of water and the consequent drying.

MAINTENANCE:

the frequent cleaning is essential to preserve the beauty of stainless steel profiles surfaces. Pay close attention to the treatment of the profiles' surface during the installation. Immediately after installation, clean by rinsing the surfaces accurately. Avoid the use of abrasive products that may scratch the profile. Do not use cleansers containing chlorine and its compounds, such as bleach, muriatic acid, decalcifying agents. Do not use abrasive sponges or wire wools that may scratch the surface or leave rust stains.

Rigid PVC

Vinyl compound of rigid PVC unleaded, anti shock, non-flammable. Mixture eco-friendly with Ca-Zn salts.

Plasticized PVC

Vinyl compound of plasticized PVC unleaded, non-flammable. Mixture eco-friendly with Ca-Zn salts.

Foam PVC

Vinyl compound of plasticized PVC unleaded, non-flammable. Mixture eco-friendly with Ca-Zn salts.

Co-extruded PVC - Foam/Rigid

Vinyl compound of plasticized PVC unleaded, non-flammable. Mixture eco-friendly with Ca-Zn salts.

Vinyl compound of rigid PVC unleaded, anti shock, non-flammable. Mixture eco-friendly with Ca-Zn salts.

Co-extruded PVC - Rigid/Rigid

Vinyl compound of rigid PVC unleaded, anti-shock non-flammable. Mixture eco-friendly with Ca-Zn salts.

Co-extruded PVC - Plasticized/Plasticized

Vinyl compound of plasticized PVC unleaded, non-flammable. Mixture eco-friendly with Ca-Zn salts.

Co-extruded PVC - Rigid/Plasticized

Vinyl compound of rigid PVC unleaded, anti-shock, non-flammable. Mixture eco-friendly with Ca-Zn salts. Vinyl compound of plasticized PVC unleaded, non-flammable. Mixture eco-friendly with Ca-Zn salts.

Co-extruded PVC - Rigid/Plasticized anti-mould

Vinyl compound of rigid PVC unleaded, anti-shock, non-flammable. Mixture eco-friendly with Ca-Zn salts. Vinyl compound of plasticized PVC unleaded, non-flammable, addicted with biocide. Mixture eco-friendly with Ca-Zn salts.

Co-extruded PVC - Foam/Plasticized

Vinyl compound of foam PVC unleaded, non-flammable. Mixture eco-friendly with Ca-Zn salts. Vinyl compound of plasticized PVC unleaded, non-flammable. Mixture eco-friendly with Ca-Zn salts.

ADVICES FOR CLEANING AND MAINTENANCE

| MATERIAL | FINISHING | CLEANING AFTER LAYING | MAINTENANCE |
|-----------------|--------------------------|---|--|
| aluminium | anodised | Use of acid based cleaners and not alkaline | exclusive use of neutral cleaning products |
| aluminium | bril. polished | Use of acid based cleaners and not alkaline | exclusive use of neutral cleaning products |
| aluminium | bright polished copper | Use of acid based cleaners and not alkaline | exclusive use of neutral cleaning products |
| aluminium | bright polished titanium | Use of acid based cleaners and not alkaline | exclusive use of neutral cleaning products |
| aluminium | bright polished gold | Use of acid based cleaners and not alkaline | Exclusive use of neutral cleaning products |
| aluminium | color-coated | Use of acid based cleaners | use neutral or alkaline detergents |
| aluminium | bright brushed | Use of acid based cleaners and not alkaline | exclusive use of neutral cleaning products |
| aluminium | riv. Alcrom Plus | Use of acid based cleaners | Exclusive use of neutral cleaning products |
| stainless steel | polished | Use of acid based cleaners without chlorine | use neutral or alkaline detergents |
| stainless steel | Inox AISI 316 | Use of acid based cleaners | exclusive use of neutral cleaning products |
| stainless steel | sandblast | Use of acid based cleaners only neutral | use neutral or alkaline detergents |
| stainless steel | brushed | Use of acid based cleaners without chlorine | use neutral or alkaline detergents |
| brass | natural | Use of acid based cleaners only neutral | exclusive use of neutral cleaning products |
| brass | polished | Use of acid based cleaners only neutral | exclusive use of neutral cleaning products |
| brass | chromium - plated | Use of acid based cleaners | use neutral or alkaline detergents |
| PVC | | Use of acid based cleaners and not alkaline | exclusive use of neutral cleaning products |

PROFILES CHARACTERISTICS AND PACKAGING

SELF-ADHESIVE PROFILES

Self-adhesive profiles are made of non-toxic, non-flammable and solvent free hot-melt glues. Although these products are non-flammable, it is recommended not to expose them to naked flames. Product preservation is guaranteed when stored in "normal" climatic conditions.

Glue deteriorates at temperatures over +90°C and crystallizes at temperatures below -15°C. During the application, the temperature of self-adhesive profiles and the ambient temperature where profiles have to be laid should not be below +10°C.

Important: self-adhesive profiles cannot be laid on friable supports, as junction between two carpet floors or between PVC floors and wall coverings.

DRILLED PROFILES

Screw-mounted profiles are drilled according to the model and the material at issue, so that to lodge 3 mm or 3,5 mm screws, either flat-head or round-head ones.

PACKAGING

The  means blister packaging.

"Individually packed" means that the packaging is made for the single profile with a protective heat shrink film.

MEASURES - TOLERANCES - REFERENCES NORMS - CERTIFICATION ON PRODUCT

Please note that the information and the drawings in the present catalogue are not binding.

The data about measures, such as length, thickness and width refer to nominal measures. The foreseen tolerances, the related norms and reference certifications are indicated in the specifications of products, available on request.

DIRECTIONS

The resistance to chemical products depends on their degree of chemical aggressiveness and therefore it is necessary to make sure in advance of the effects that products used for profile laying, cleaning and maintenance can produce. In particular lime, mortar or tile glue cause strains on the visible surface of profiles. Therefore it is necessary to clean these parts immediately after the laying of the profiles. Please note that in the present catalogue, due to the printing, the colour shades can be slightly different from the real ones.

GENERAL CONDITIONS OF SALE

These General Conditions shall govern all sales contracts executed between Profilpas S.p.A. and the Buyer and shall prevail on all the Buyer's general or individual purchasing conditions. Any derogation to these General Conditions shall be binding on Profilpas only if accepted in writing by the latter.

1. Prices

The prices shown in Profilpas' price list are in Euro per meter but products will be invoiced in Euro per piece with the discounts granted in accordance with the ordered quantities or upon agreement with Profilpas. Prices are exclusive of additional taxes or customs duties. Profilpas expressly reserves the right to modify the prices without notice, in accordance with any fluctuation in the costs of raw materials.

2. Minimum orders

The required minimum order value is fixed at the amount of Euro 500,00.

3. Orders

Purchase orders must be sent in writing. Orders shall be deemed accepted and binding on Profilpas only after receipt by the Buyer of Profilpas' written order confirmation. Only the discounts and the prices indicated in the order confirmation shall be binding for Profilpas. Should the order confirmation contain amendments with respect to the Order, such amendments shall be deemed tacitly accepted by the Buyer after 5 (five) days from receipt of the order confirmation unless the Buyer notifies its disagreement in writing within the above-mentioned term.

4. Delivery terms

Deliveries shall be made EX WORKS (Incoterms 2010) Profilpas warehouse in Cadoneghe (Padova) - Italy. The products shall always be transported at the Buyer's risk according to the Incoterms, and any reimbursements for damages shall be claimed by the Buyer to the carrier in accordance with the relevant agreements and clauses contained in the stipulated insurance policies. Delivery dates are estimated and not guaranteed. Profilpas shall not be responsible for any delay nor for the consequences thereof. In case of delay in delivery, the Buyer shall not have the right to terminate the sales agreement and/or obtain compensation of any direct, indirect or consequential damage suffered, unless in case of intent or gross negligence.

5. Packaging

Prices include Profilpas standard packaging. Sea shipment packaging or any other special packaging requested by the Buyer will be charged at cost. Profilpas' catalogue indicates which products have partial packaging and the surcharge applied in such case.

6. Terms of payment

All payments must be made in accordance with the agreed terms of payment; the relevant sums must be transferred to the bank indicated by Profilpas. In case of delay of payment, whether total or partial, the Buyer shall be bound to pay interest on all outstanding amounts calculated according to art. 5 of Italian Legislative Decree no. 231/2002 or subsequent modifications. Delay or non-payment of any sums due by the Buyer to Profilpas, even if concerning different contractual relationships, shall entitle Profilpas to suspend the preparation and delivery of the products which are the object of the order and of any other order in progress.

7. Claims

Claims must be notified in writing to Profilpas within 10 days from the delivery date. Claims for damaged, stolen or missing products shall be lodged with the carrier upon receipt of the products. If no written complaint is lodged with the carrier, Profilpas will not accept any return or replacement of the delivered products. Return of products will only be accepted upon Profilpas' prior written consent and always at the Buyer's expense.

8. Retention of title (article 1523 of the Italian Civil Code)

The products shall remain the property of Profilpas until full payment. Non-compliance, or partial compliance, of the agreed payment terms al-low Profilpas, without prejudice to any other claim it may have, to recover the products supplied. The Buyer is liable for any damage to the products due to poor storage or negligence and shall be responsible as a deposi-tary. Profilpas does not assume responsibility for damage to the products consequential or subsequent to the installation of the same.

9. Warranty and defects

Profilpas guarantees that the products are free from defects in material and workmanship for a period of 12 months from the date of delivery to the Buyer. Should Profilpas acknowledge the existence of the claimed defects, and provided that it has been promptly notified in accordance with the above mentioned paragraph "Claims", Profilpas' warranty shall be limited, at its discretion, to the replacement of the defective products, free of charge EXW Profilpas' premises (Incoterms 2010), within the nor-mal time required therefor, or to the issue of a credit note for the amount of the defective products, ANY OTHER LEGAL OR CONVENTIONAL WAR-RANTY OR CLAIMS FOR ANY FURTHER DIRECT, INDIRECT OR CONSE-QUENTIAL DAMAGES SUSTAINED BY THE BUYER OR THIRD PARTIES, UNLESS IN CASE OF INTENT OR GROSS NEGLIGENCE OR IN CASES OF MANDATORY LEGAL REQUIREMENTS, BEING EXPRESSLY EXCLUDED. The Buyer expressly waives its right of regress according to article 134 of the Italian Consumers' Code.

No products will be returned by the Buyer without prior written permis-sion by Profilpas. Profilpas does not guarantee the compliance of the products to any particular specifications or technical characteristics or their suitability for any use and/or special uses if not to the extent that such characteristics have been expressly agreed in the sales contract. Profilpas is not liable for damages that the Buyer, or third parties, gener-ate by using the products if the damage does not depend on the quality or intrinsic characteristics of the product, but by the choice of purchase and usage of the same by the Buyer.

10. Industrial and intellectual property

Profilpas Spa's trademarks, distinguishing signs, designs, photographs of products and/or production and commercial technology shall be considered strictly confidential and shall not be used without prior written authorization from the same.

11. Express delivery

Upon the Buyer's request, Profilpas can offer a service of express deliv-ery. The surcharge for this express service will be communicated with the order confirmation.

12. Privacy

The parties undertake to comply with the laws - including EU Regulation 2016/679 "General data protection regulation" or "GDPR" - on the protec-tion and processing of personal data that may apply to the relationships between the Parties pursuant to this agreement and assume the qualifi-cation as "data controller" in relation to the personal data acquired in the performance of this agreement. The parties declare that they have secu-rity devices and systems which are appropriate for the protection of the personal data in their possession, including the personal data acquired hereunder, against risks of destruction or loss, also accidental, unauthor-ized access, processing not allowed or not consistent with the purpose of the data collection.

13. Final clauses

Profilpas sales are governed by the laws of Italy. In case of dispute, the courts of Milan – Italy shall be the exclusive competent venue.

| | | | | | |
|-----------------|-----------------|-----------------|-----|------------------|-----------|
| 020/ | 104 | 89/613 | 200 | 99/M | 102 |
| 023/ | 107 | 89/613EI | 200 | 99/R/ | 102 |
| 024/ | 107 | 89H/ | 198 | 99/T/ | 100 - 185 |
| 026/ | 105 | 89H/ EI | 198 | 99/TR/26 | 100 - 185 |
| 030/ | 107 | 90/ A | 194 | 100/ | 204 |
| 040/ | 107 | 90/ BSF | 194 | 101/74 | 204 |
| 050/ | 131 | 90/ E | 195 | 105/7 | 201 |
| 060/ | 131 | 90/ G | 195 | 105/7E | 201 |
| 076/ | 44 | 90/ I | 195 | 105/7G | 201 |
| 080/ | 131 | 90/ MI | 195 | 105/7I | 201 |
| 0100/ | 131 | 90/ ME | 195 | 105/7P | 201 |
| 6/ | 117 | 90/ MG | 195 | 105/CB | 201 |
| 10/ | 117 | 90/ MP | 195 | 110/ | 156 |
| 19/ | 106 | 90/ P | 195 | 111/ /F | 153 - 186 |
| 21/ | 103 | 90/ SF | 194 | 124/ | 156 |
| 22/A | 106 - 178 - 179 | 90/ SSF | 194 | 125/ | 158 |
| 25/ | 106 | 90/ TMSF | 194 | 126/ | 157 |
| 30/ | 103 | 90H/6ME | 195 | 126/L/F | 231 |
| 35/ | 103 | 90H/6MG | 195 | 126/LP/DX | 231 |
| 41/ | 103 | 90H/6MI | 195 | 126/LP/SX | 231 |
| 45/ | 112 | 90H/6MP | 195 | 130/ | 155 |
| 46/ | 117 | 90H/6SF | 194 | 148/B | 222 |
| 50/A | 178 - 179 | 92/7 | 197 | 148/C | 222 |
| 54/ | 117 | 93/ | 197 | 150 | 160 |
| 55/ | 55/ | 94/7SF | 205 | 150/ | 164 |
| 57/ | 114 | 95/ E | 205 | 151 | 160 |
| 58/ | 154 - 180 | 95/ G | 205 | 151/11 | 164 |
| 61/ | 114 | 95/ I | 205 | 152 | 160 |
| 63/A | 178 - 179 | 95/ P | 205 | 154 | 161 |
| 70/ | 155 | 95/ SF | 205 | 155 | 161 |
| 71/ | 155 | 97/4E | 207 | 155/16 | 164 |
| 72/ | 158 | 97/4G | 207 | 156 | 161 |
| 73/ | 154 - 180 | 97/4I | 207 | 161/11 | 165 |
| 74/ | 154 - 180 | 97/4P | 207 | 163/ | 164 |
| 75/F | 153 - 186 | 97/4SF | 207 | 168/16 | 165 |
| 76/ | 156 | 97/7E | 208 | 169 | 223 |
| 78/ | 159 | 97/7G | 208 | 169/ | 165 |
| 79/ | 158 | 97/7I | 208 | 170 | 223 |
| 80/ | 157 | 97/7P | 208 | 170/ | 165 |
| 87/ | 154 | 97/7SF | 208 | 171 | 223 |
| 87/6 | 202 - 233 | 97/8CB | 209 | 171/11 | 165 |
| 88/6 | 202 - 233 | 97/8E | 209 | 172 | 222 |
| 88/16SF | 202 | 97/8G | 209 | 173 | 222 |
| 88/16L/A | 202 - 233 | 97/8I | 209 | 174/ | 165 |
| 88/6E | 202 - 233 | 97/8P | 209 | 175/11 | 165 |
| 89/ | 198 - 199 | 97/8SF | 209 | 177/16 | 165 |
| 89/ EI | 198 - 199 | 98/7E | 206 | 178/16 | 165 |
| 89/ TM | 198 | 98/7G | 206 | 210/ | 42 |
| 89/ TMEI | 198 | 98/7I | 206 | 210H/A | 42 |
| 89/6L | 199 - 234 | 98/7P | 206 | 220/ | 42 |
| 89/6EI | 199 - 234 | 98/7SF | 206 | 277/ | 42 |

| | | | | | |
|----------|-----------------|--------------|-----------------------|--------------|-----------------|
| 300/ | 116 | 790/ MGS | 196 | 8603/I | 220 |
| 311/ | 115 | 790/ MI | 196 | 8603/P dx/sx | 220 |
| 312/ | 115 | 790/ MIS | 196 | 8605 | 212 |
| 370/ | 154 | 790/ MP | 196 | 8606 | 212 |
| 373/ | 154 | 790/ MPS | 196 | 8607 | 221 |
| 380/8 | 99 | 790/ SF | 196 | 8607/E | 221 |
| 399/10 | 102 | 799/ | 99 | 8607/G | 221 |
| 399/M | 102 | 799/T/ | 101 | 8607/I | 221 |
| 399/R/ | 102 | 799/TS/ | 101 | 8607/P dx/sx | 221 |
| 399/T/ | 101 - 185 | 799/U/ | 99 | 8608 | 213 |
| 399/TC/ | 101 - 185 | 4020/ | 104 | 8608/C | 197 - 213 - 215 |
| 399/U | 99 | 4026/ | 105 | 8610 | 45 |
| 419/ | 106 | 4030/ | 107 | 8611 | 45 |
| 422/AD | 106 - 178 - 179 | 4050/ | 131 | 8612/10 | 216 |
| 425/ | 106 | 4060/ | 131 | 8613 | 215 |
| 430/ | 103 | 4080/ | 131 | 8614 | 216 |
| 441/ | 103 | 4150/11/S | 164 | 8615 | 214 |
| 450/AD | 178 - 179 | 4170/ /S | 165 | 8616 | 214 |
| 455/ | 114 | 4300/ | 116 | 30052 | 250 |
| 457/ | 114 | 4311/ | 115 | AF/1 | 51 - 203 |
| 461/ | 114 | 4312/ | 115 | AI/ | 28 - 94 - 187 |
| 470/ | 155 | 4399/R/10 | 102 | AI/ /E | 28 |
| 473/ | 154 | 4399/T | 101 | AIF/ | 96 |
| 474/ | 154 | 4701/ | 116 | AIL/ | 28 |
| 476/ | 156 | 4711/ | 115 | AIP/ | 28 |
| 487/ | 154 | 4712/ | 115 | AIS/ | 28 - 94 |
| 499/T | 100 | 4720/ | 104 | AIS/ /E | 28 |
| 700/ | 116 | 4722/ | 104 | AIX/ | 28 - 94 |
| 701/ | 116 | 4726/ | 105 | AL/120/24 | 236 |
| 711/ | 115 | 4729/ | 105 | AL/150/24 | 236 |
| 712/ | 115 | 4730/ | 107 | AL/60/24 | 236 |
| 720/ | 104 | 4750/ | 131 | AL/90/24 | 236 |
| 722/ | 104 | 4760/ | 131 | AX/2/ | 41 |
| 723/ | 107 | 4780/ | 131 | BH/20 | 91 |
| 724/ | 107 | 4799/T | 101 | BH/20/A | 91 |
| 726/ | 105 | 4799/TS | 101 | BI/40 | 63 |
| 729/ | 105 | 7100/ | 131 | BI/40/A | 63 |
| 730/ | 107 | 8181 | 217 | BL/ | 62 |
| 732/SF/ | 116 | 8580 | 218 | BLA/ | 62 |
| 740/ | 107 | 8582 | 218 | BLAH/ | 62 |
| 750/ | 131 | 8596 | 218 | BP/20 | 91 |
| 760/ | 131 | 8598 | 218 | BP/20/A | 91 |
| 774/ | 43 | 8600 | 217 | BP/22 | 90 |
| 775/ | 43 | 8602 | 219 | BP/25 | 90 |
| 776/ | 43 | 8602/C | 207 - 219 - 220 - 221 | BP/20 | 91 |
| 777/ | 43 | 8602/E | 219 | BPK/25 | 90 |
| 779/SF | 43 | 8602/I | 219 | BPT/20 | 91 |
| 780/ | 131 | 8602/P dx/sx | 219 | BPT/22 | 90 |
| 790/ ME | 196 | 8603 | 220 | BPT/25 | 90 |
| 790/ MES | 196 | 8603/E | 220 | C/10/SF | 172 |
| 790/ MG | 196 | 8603/G | 220 | C/13/SF | 172 |

| | | | | | |
|--------------|-----------|-------------|-----|-----------|----------|
| C/22/SF | 172 | CPHA/ | 144 | FIX/J/30 | 183 |
| C/4 | 176 | CPHV/ | 144 | FIX/J/44 | 182 |
| C/7/SF | 170 - 171 | CPHA/ /E | 144 | FIX/L/32 | 183 |
| CE/10/100 | 237 | CPHV/ /E | 144 | FIX/L/55 | 182 |
| CE/10/20 | 237 | CPLB | 145 | FIX/T/19 | 183 |
| CE/5/20 | 237 | CPLB/2 | 145 | FIX/T/33 | 182 |
| CE/RGB/20 | 237 | CPLV/ | 145 | FLM/C | 246 |
| CLA/ | 227 | CPLV/ /E | 145 | FLM/S | 246 |
| CLA/8A | 227 | CPLV/ /G | 145 | FMA/ | 40 |
| CLA/8P | 227 | CPNV/45/ | 142 | FMAC/ | 40 |
| CN28 | 248 | CPNV/45/ /E | 142 | FMAE/ | 40 |
| CPBV/ | 143 | CPNV/45/ /G | 142 | FMAI/ | 40 |
| CPBV/ /E | 143 | CPNVF/45/ | 142 | FMB/ | 40 |
| CPBV/ /G | 143 | CPQV/50/ | 139 | FMBC/ | 40 |
| CPCI/55/ | 134 | CPQV/50/ /E | 139 | FMBE/ | 40 |
| CPCI/55/ /E | 135 | CPQV/50/G | 139 | FMBI/ | 40 |
| CPCI/55/ /G | 135 | CPQV/70/ | 139 | FMI/ | 40 |
| CPCI/75/ | 134 | CPQV/70/ /E | 139 | FMIC/ | 40 |
| CPCI/75/ /E | 135 | CPQV/70/G | 139 | FMICS/ | 40 |
| CPCI/75/ /G | 135 | D/4461/K | 249 | FMIE/ | 40 |
| CPCI/95/ | 134 | D/4471/K | 249 | FMIES/ | 40 |
| CPCI/95/ /E | 135 | DC1 | 248 | FMII/ | 40 |
| CPCI/95/ /G | 135 | DC10 | 248 | FMIIS/ | 40 |
| CPCV/30/ | 136 | DC2 | 248 | FMIS/ | 40 |
| CPCV/30/ /E | 136 | DC3 | 248 | G/2/SF | 174 |
| CPCV/30/ /G | 136 | DC4 | 248 | G/4/SF | 175 |
| CPCV/55/ | 134 | DC5 | 248 | G/40/ | 130 |
| CPCV/55/ /E | 135 | DC7 | 248 | G/460/ | 130 |
| CPCV/55/ /G | 135 | DCE4 | 248 | G/60/ | 130 |
| CPCV/75/ | 134 | DI/ | 97 | G/705/F | 186 |
| CPCV/75/ /E | 135 | DIMM/02 | 236 | G/80/ | 130 |
| CPCV/75/ /G | 135 | DJA/ | 97 | G/9/F | 230 |
| CPCV/95/ | 134 | DJA/ /EI | 97 | G/9P/DX | 230 |
| CPCV/95/ /E | 135 | DJAF/ | 97 | G/9P/SX | 230 |
| CPCV/95/ /G | 135 | DJG/ | 97 | GA/ | 56 - 188 |
| CPCVD/30/ | 137 | DJG/ /EI | 97 | GAN/ | 57 |
| CPCVD/30/ /E | 137 | DJK/ | 97 | GBL/ /C | 62 |
| CPCVD/30/ /G | 137 | DJK/ /EI | 97 | GBL/ /E | 62 |
| CPCVF/55/ | 134 | DJKC/10 | 52 | GBL/ /I | 62 |
| CPEI/45/ | 140 | DJKG/10 | 53 | GBL/ /T | 62 |
| CPEI/45/ /E | 141 | DJKG/10 | 53 | GF/ | 153 |
| CPEI/45/ /G | 141 | DJN/ | 97 | GG/2 | 82 |
| CPEV/45/ | 140 | DJN/ /EI | 97 | GG/3 | 82 |
| CPEV/45/ /E | 141 | DJNF/ | 97 | GG/4 | 82 |
| CPEV/45/ /G | 141 | DT1 | 248 | GIC/ | 60 |
| CPEV/72/ | 140 | DT10 | 248 | GIN/ | 58 |
| CPEV/72/ /E | 141 | DT2 | 248 | GIN/ /SA | 58 |
| CPEV/72/ /G | 141 | DT3 | 248 | GINS/ | 58 |
| CPGV/55/ | 138 | DT4 | 248 | GINS/ /SA | 58 |
| CPGV/55/ /E | 138 | DT5 | 248 | GINX/ | 58 |
| CPGV/55/ /G | 138 | DT7 | 248 | GINX/ /SA | 58 |

| | |
|-----------------|----------------------|
| GJA/ | 129 |
| GJF/ | 129 |
| GJS/10 | 129 |
| GM12/L | 123 |
| GM/10 | 123 |
| GM/72 | 158 |
| GM/78 | 159 |
| GM/I | 122 |
| GM/R | 158 |
| GMP/I | 122 |
| GMR/44 | 157 - 231 |
| GP/ | 59 |
| GPS/6 | 82 |
| GPS1/ /19 | 82 |
| GPS14/12 | 83 |
| GPS2/ | 83 |
| GPS3/ /10 | 84 - 85 |
| GPS3/ /11 | 84 - 85 |
| GPS3/ /12 | 84 - 85 |
| GPS4/ /10 | 86 - 87 |
| GPS4/ /11 | 86 - 87 |
| GPS4/ /12 | 86 - 87 |
| GPS5/10/ | 88 |
| GPS5/11/ | 88 |
| GPS5/12/ | 88 |
| GPU/ | 59 |
| GR/80/ | 130 |
| GTA/E | 56 |
| GTA/I | 56 |
| GTIN/C | 58 |
| GTIN/E | 58 - 60 |
| GTIN/G | 58 - 60 |
| GTIN/I | 58 - 60 |
| GTIN/T | 58 - 60 |
| GTINS/C | 58 |
| GTINS/E | 58 |
| GTINS/G | 58 |
| GTINS/I | 58 |
| GTINS/T | 58 |
| GTINX/C | 58 |
| GTINX/E | 58 |
| GTINX/G | 58 |
| GTINX/I | 58 |
| GTINX/T | 58 |
| GTL/C | 63 |
| GTL/E | 63 |
| GTL/I | 63 |
| GTL/T | 63 |
| GTP/C | 57 - 59 |
| GTP/E | 57 - 59 |
| GTP/I | 57 - 59 |
| GTP/T | 57 - 59 |
| GTV/E | 56 |
| GTV/I | 56 |
| GU/30/ | 89 |
| GU/40/ | 89 |
| GV/ | 56 |
| GVNH/ | 57 |
| GWA/ | 129 |
| H3502 | 162 |
| H/5/F | 185 |
| IL/ | 46 |
| ILN/ | 46 |
| ILNS/ | 46 |
| ILNX/ | 46 |
| IP/40 | 44 |
| IPA/ | 31 - 149 |
| IPB/ | 31 - 149 |
| IP/ | 31 - 149 |
| IPV/ | 31 |
| IR/C01 | 237 |
| IR/C01NT | 237 |
| IR/C02 | 237 |
| IR/C03 | 237 |
| IR/W3 | 237 |
| JGA/ | 188 |
| K10 | 249 |
| KLM/10 | 246 - 247 |
| KLM/15 | 246 - 247 |
| KLM/20 | 246 - 247 |
| KLM/30 | 246 - 247 |
| KLM/50 | 246 - 247 |
| KLM/C | 247 |
| KLM/T10 | 246 - 247 |
| KLM/T15 | 246 - 247 |
| KLM/T20 | 246 - 247 |
| KLM/T30 | 246 - 247 |
| KLM/X10 | 246 - 247 |
| KLM/X15 | 246 - 247 |
| KLM/X20 | 246 - 247 |
| KLM/X30 | 246 - 247 |
| L5/NW/33 | 236 |
| L5/NW/65NT | 236 |
| L5/NW/67 | 236 |
| L5/NW/67NT | 236 |
| L5/RGB/67 | 236 |
| L5/WW/33 | 236 |
| L5/WW/67 | 236 |
| LA/I/ | 50 |
| LA/IS/ | 50 |
| LB/A | 50 |
| LB/B/ | 50 |
| LDA/ | 50 |
| LDAD | 51 |
| LDAG/ | 50 |
| LDB/ | 50 |
| LDRS/ | 50 |
| LDS/ | 50 |
| LDTM/ | 50 |
| LDV/ | 50 |
| LLA/20 | 226 |
| LLA/20P | 226 |
| LLA/20/10 | 226 |
| LLA/30 | 226 |
| LLA/30P | 226 |
| LLB/30 | 226 |
| LLB/30P | 226 |
| LQL/2 | 228 |
| MIN/ | 41 - 113 |
| MS 45 - MS 55 | 91 - 204 - 222 - 249 |
| NAN/ | 122 |
| NE/ | 120 |
| NF/ | 121 |
| NIL/ | 123 |
| NIN/ | 123 |
| NJ/ | 120 |
| NL/ | 121 |
| NPAN/ | 122 |
| NTA/ | 124 |
| NTI/ | 124 |
| NTO/ | 124 |
| NZA/ | 125 - 184 |
| NZS/ | 125 |
| NZS/A/40 | 125 |
| NZS/B/ | 110 |
| NZS/L/ | 125 |
| NZS/S1 | 110 |
| NZS/S2 | 110 |
| PA/ | 111 |
| PAS/ | 127 |
| POLISHING PASTE | 249 |
| PBA/ | 112 |
| PBA/5/A | 184 |
| PBAS/5/F | 185 |
| PBE/ | 126 |
| PBH/ | 127 |
| PFFE/ | 128 |
| PHDE/ | 128 |
| PI/ | 61 |
| PIA/ | 61 - 188 |
| PIN/ | 60 |
| PLA/ | 113 |
| PN/ | 111 |

| | | | | | |
|------------------------|----------|--------------------|-----------------------|-------------------|-----|
| PNI/ | 111 | RINS/ | 35 | STA/ | 124 |
| PNIS/ | 111 | RINX/ | 35 | STI/ | 124 |
| PP/ | 68 | RIP/ | 34 | TA/ | 33 |
| PP360/ | 68 | RIS/ | 34 | TAS/ | 33 |
| PP50/ | 68 | RIX/ | 34 | TATM/ | 33 |
| PROFLEX MACHINE | 250 | RKN/ | 36 | TB/ | 33 |
| PT/4 | 177 | RLN/ | 36 | TE/ | 38 |
| PT/4/SA | 177 | RPA/ | 37 | TEI/ | 38 |
| PT/6 | 177 | RR/5 | 249 | TEL/04 | 236 |
| PT/6/SA | 177 | RTM/ | 32 | TEL/RGB/04 | 236 |
| PTC | 245 | RV/ | 32 | TGU/ | 89 |
| PTC/3000 | 245 | RVH/ | 32 | THIN/ | 73 |
| PTC1 | 245 | S/15/SF | 172 | TIA/ | 33 |
| PTC1/3000 | 245 | S/4 | 176 | TIAS/ | 33 |
| PTC1A | 245 | S/9/SF | 170 - 171 | TIB/ | 33 |
| PTC1A/3000 | 245 | S/95 | 197 - 205 - 206 - 208 | TIE/ | 34 |
| PTC2 | 245 | S/97 | 209 | TIEL/ | 36 |
| PTC2/3000 | 245 | SA/ | 152 | TIEN/ | 35 |
| PTC3 | 245 | SA/G | 152 | TIENS/ | 35 |
| PTC3/3000 | 245 | SAFETY-STEP | 162 - 163 | TIENX/ | 35 |
| PTC4/1 | 245 | SAR/10/12 | 150 | TIEP/ | 34 |
| PTC4/2 | 245 | SAR/8/15 | 150 | TIES/ | 34 |
| PTC4/3 | 245 | SB/ | 152 | TIEX/ | 34 |
| PTC4/5 | 245 | SB/G | 152 | TII/ | 34 |
| PTLN | 245 | SGA/ | 148 | TIIL/ | 36 |
| PTS | 245 | SGA/11L | 230 | TIIN/ | 35 |
| PTWN | 245 | SGA/11P | 230 | TIINS/ | 35 |
| PTWN/1400 | 245 | SGI/ | 148 | TIINX/ | 35 |
| PV/ | 30 | SGK/ | 148 | TIIP/ | 34 |
| QDC/1010 | 79 | SGN/ | 148 | TIIS/ | 34 |
| QDCC/1010 | 79 | SIR/10/12 | 150 | TIIX/ | 34 |
| QDI/1010 | 79 | SIR/8/15 | 150 | TIME/ | 35 |
| QDL/1010 | 79 | SIRS/10/12 | 150 | TIMI/ | 35 |
| RA/ | 32 - 187 | SIRS/8/15 | 150 | TIV/ | 33 |
| RAS/ | 32 | SIS/ | 151 | TLA/10/C1 | 227 |
| RB/ | 32 | SIS/10/SF | 151 | TLA/10P/C1 | 227 |
| RC/ /F | 181 | SIX/ | 151 | TLB/10/C1 | 227 |
| RC/411/CV | 181 | SKL/2 | 203 - 232 | TLB/10P/C1 | 227 |
| RC/415/CV | 181 | SLIM/ | 75 | TOP/ /E | 47 |
| RC/47/CV | 181 | SLIM-I/ | 75 | TOP/ /ETM | 47 |
| RC/49/CV | 181 | SM/ | 148 | TOP/ /I | 47 |
| RC/5/F | 185 | SMA/ | 148 | TOP/ /ITM | 47 |
| RCF/ | 181 | SMART/ | 77 | TOP/A/ | 47 |
| RE/ | 38 | SMART3/ | 77 | TOP/TM/ | 47 |
| REC/ /100 | 39 | SMART-I/ | 77 | TPAE/ | 37 |
| RECO/ /80 | 39 | SN/ | 149 | TPAI/ | 37 |
| RI/ | 34 - 187 | SNG/ | 149 | TPC/410/CV | 173 |
| RIC/01 | 236 | SP/ | 152 | TPC/413/CV | 173 |
| RIC/RGB/M | 237 | SS/4 | 249 | TPC/47/CV | 173 |
| RIC/RGB/S | 237 | SS/5 | 249 | TPS/410/CV | 173 |
| RIN/ | 35 | ST/7 | 124 | TPS/413/CV | 173 |

| | |
|------------|-----------------------|
| TPS/47/CV | 173 |
| TPU/ | 171 - 172 - 174 - 175 |
| TPZ/410/CV | 173 |
| TPZ/413/CV | 173 |
| TPZ/47/CV | 173 |
| TU/6 | 171 - 172 - 174 - 175 |
| TV/ | 33 |
| UA/ | 98 |
| UA/ /EI | 98 |
| UG/ | 98 |
| UG/ /EI | 98 |
| UI/ | 98 |
| UI/ /EI | 98 |
| UIS/ | 98 |
| UIS/ /EI | 98 |
| UK/ | 98 |
| UK/ /EI | 98 |
| UKC/10 | 52 |
| UKG/10 | 53 |
| UKGC/10 | 53 |
| UN/ | 98 |
| UN/ /EI | 98 |
| VITI | 249 |
| XLC/ | 77 |
| XLC3/ | 77 |
| XLCC/ | 77 |
| XLL/ | 77 |
| XPC/ | 69 |
| XPD/ | 71 |
| XPF/ | 70 |
| XPI/ | 71 |
| XSC/ | 75 |
| XSCC/ | 75 |
| XSL/ | 75 |
| XTC/ | 73 |
| XTCC/ | 73 |
| XTL/ | 73 |
| XTT/ | 73 |
| Z/1/SF | 170 - 171 |
| Z/4 | 176 |
| Z3/30/SF | 172 |
| ZA/ | 26 - 94 |
| ZB/ | 26 |
| ZBG/ | 95 |
| ZBGF/ | 96 |
| ZBS/ | 26 |
| ZG/ | 94 |
| ZGF/ | 96 - 186 |
| ZK/ | 29 - 94 |
| ZN/ | 94 |
| ZNF/ | 96 |

| | |
|-------------|----------|
| ZQAGN/ | 18 |
| ZQAGN/ /EI | 19 |
| ZQAL/10 | 229 |
| ZQAL/10B | 229 |
| ZQAL/10P | 229 |
| ZQAN/ | 18 - 187 |
| ZQAN/ /EI | 19 |
| ZQAND/ | 22 |
| ZQAND/ /EI | 22 |
| ZQBN/ | 18 |
| ZQBN/ /EI | 19 |
| ZQBRSN/ | 18 |
| ZQBRSN/ /EI | 19 |
| ZQBSN/ | 18 |
| ZQBSN/ /EI | 19 |
| ZQIM/ /EI | 23 |
| ZQIMP/ /EI | 23 |
| ZQIMS/ /EI | 23 |
| ZQIN/ | 23 |
| ZQIN/ /EI | 23 |
| ZQINP/ | 23 |
| ZQINP/ /EI | 23 |
| ZQINS/ | 23 |
| ZQINS/ /EI | 23 |
| ZQINX/ | 23 |
| ZQINX/ /EI | 23 |
| ZQKN/ | 24 - 187 |
| ZQKN/ /EI | 24 |
| ZQLN/ | 24 |
| ZQLN/ /EI | 24 |
| ZQP/ | 25 |
| ZQP/ /EI | 25 |
| ZQTMN/ | 18 |
| ZQTMN/ /EI | 19 |
| ZQVN/ | 18 |
| ZQVN/ /EI | 19 |
| ZQVNH/ | 18 |
| ZTM/ | 26 |
| ZV/ | 26 - 27 |
| ZVH/ | 26 |



Profilpas S.p.A.

Registered office:

Viale E. Jenner, 4
20159 Milano (MI) Italy

Head office and plant:

Via Einstein, 38
35010 Cadoneghe (PD) Italy

Customer Service Italy: +39 049 8878411
Customer Service Export: +39 049 8878412

info@profilpas.com
profilpas.com

